

## SPECIFICATION



65t



45.5m



62m

# SRC650T

SANY ROUGH TERRAIN CRANE

QUALITY CHANGES THE WORLD

[www.sanyglobal.com](http://www.sanyglobal.com)

It is one of the core business units in SANY Group, specializing in the development and manufacturing of high-end wheel cranes, crawler cranes and tower cranes, including the complete range of wheel cranes from 8 to 2400t, crawler cranes from 25 to 4500t and tower cranes from 6 to 185t.

三一集团旗下核心事业部，从事高端轮式起重机、履带起重机、塔式起重机系列产品的研发制造。覆盖8-2400吨全吨位轮式起重机，25-4500吨全吨位履带起重机，6-185吨塔式起重机。



SANY CRANE



# SRC650T

SANY ROUGH TERRAIN CRANE  
65T LIFTING CAPACITY

A 65t rough terrain crane with five section 45.5m boom, featuring stronger capacity yet reduced self-weight. Key components come from name brands of reliable quality. Operator comfort is improved by brand new cab design.

一款最大起重量65吨，5节臂，全伸臂长45.5m的越野起重机，自重轻，性能强。核心部件均为知名供应商提供，质量稳定可靠；配备全新操纵室，驾驶、操作舒适度全面升级。



## **All new operator's cab**

Ergonomic concept of safety and comfort

### **全新操纵室**

操作安全、舒适、人机工程全面升级

## **Convenient transport**

One-trailer transport at low operational cost

### **超便捷运输**

一车整运，运营成本低

## **Brand-name components**

DF Cummins engine/Dana transmission /Meritor axles

### **国际知名供应商**

东风康明斯发动机/德纳变速箱/美驰车桥



# All New Operator's Cab

## 全新操纵室

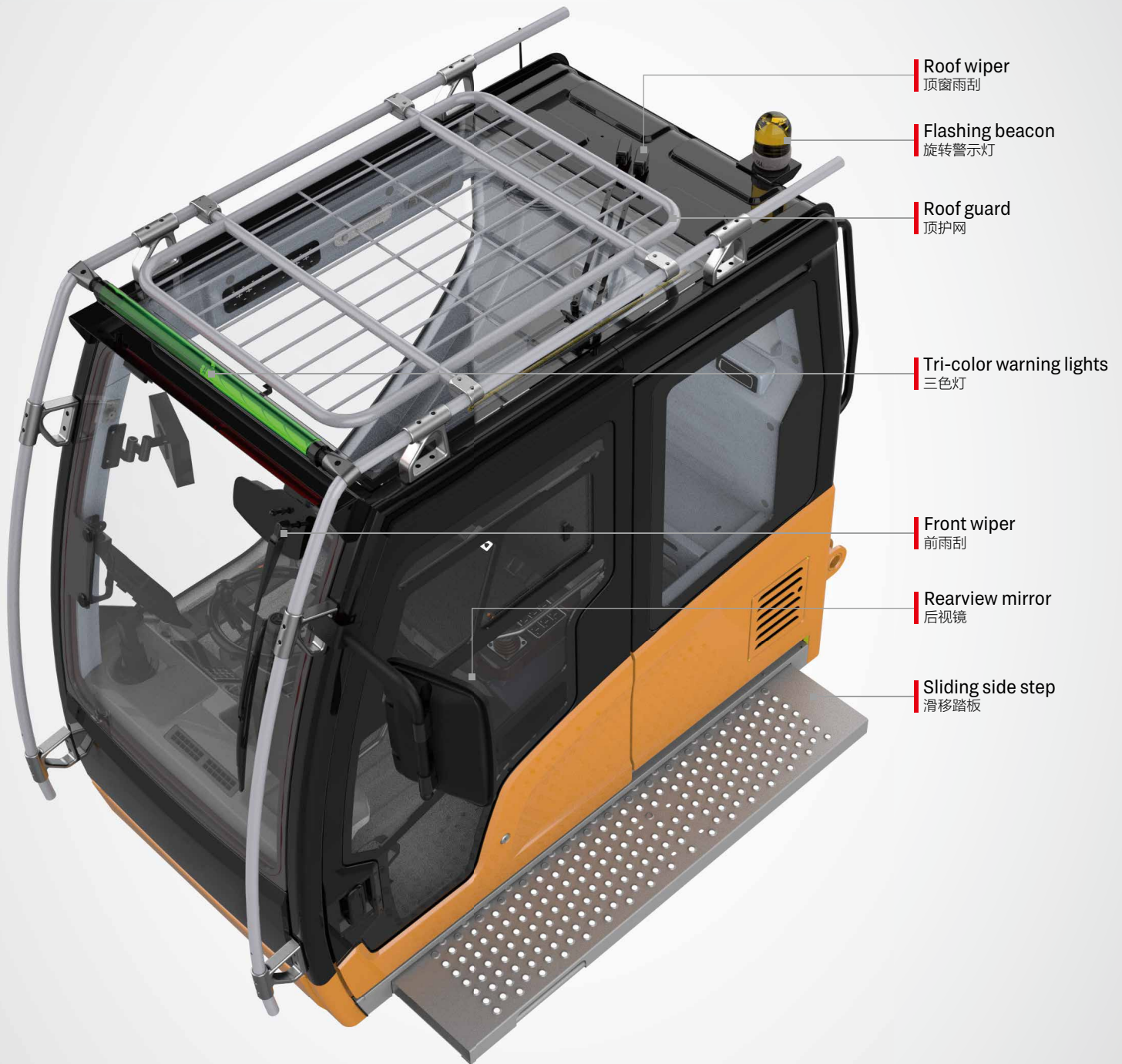

Roof wiper  
顶窗雨刮

Flashing beacon  
旋转警示灯

Roof guard  
顶护网

Tri-color warning lights  
三色灯

Front wiper  
前雨刮

Rearview mirror  
后视镜

Sliding side step  
滑移踏板



**Safety & Reliability**  
安全可靠



**Comfort & Convenience**  
舒适便捷



**Simplicity & Efficiency**  
简单高效

## SPECIFICATION

Boom telescoping  
pedal  
主臂伸缩踏板

Joystick  
手柄

Left control panel  
左扶手箱控制面板

Armrest  
扶手箱

Right control panel &  
LMI navigation knob  
右扶手箱控制面板

Rearview and  
winch monitor  
卷扬监视器

10.1 inch LMI screen  
10.1 吋显示屏

Outrigger control  
panel  
支腿控制面板

Steering column  
方向柱

Pedals  
踏板布置

Upper control panel  
辅助面板

Emergency stop  
switch  
急停开关

Bubble level  
水平仪

Cup holder  
水杯托

Joystick  
手柄

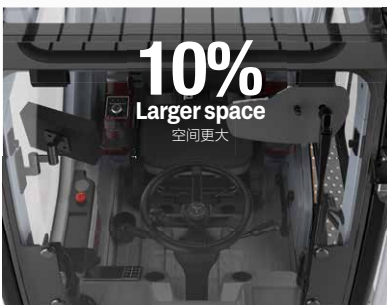
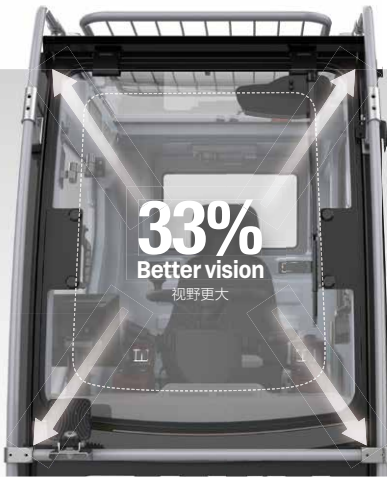

Integrating SUV genes, overall space is enlarged by 10% and forward field of vision is increased by 33%. The front windshield can be opened by 70 degrees, providing better ventilation and a second emergency exit.

融入 SUV 基因, 整体空间增大 10%, 配备超大可开合 70° 前挡风玻璃, 视野提升 33%, 增加空气对流, 并可作为快速逃生通道。



Sliding door transits between tracks when closing to make perfect thermal and acoustical insulation.

侧向变轨, 滑移门完美隔绝外部环境。

Getting in and out is made more convenient with the power sliding side step.

全宽电动伸缩踏板, 超大安全便利进出通道。



**Adjustable** steering wheel for driving and controlling, modular control panels, and smart user interface deliver intuitive and highly efficient control.

驾控一体的方向盘、模块化控制面板、UI 智能操作界面，操作简单，为高效吊装保驾护航。



# Convenient Transport

行驶运输便捷性

## Four steering modes

四种转向模型

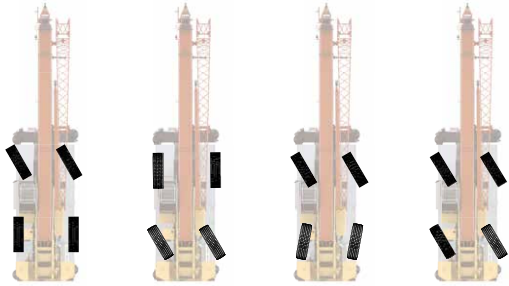

2 wheel front 前轮转向模式

2 wheel rear 后轮转向模式

4 wheel 四轮转向模式

Crab 蟹行模式



Steering control panel  
转向控制面板

## One-Trailer Transport

一车整运

The basic machine is transported at 45.4t with counterweight, jib and hooks, 3.3m wide and 3.862m high, satisfying road regulations.

主机运输尺寸为宽 3.3m, 高 3.862m, 重量为 45.4t (带配重、副臂和吊钩), 满足道路运输要求。



## Axle Load Distribution

轴荷分布

Items 项目		Weight (kg) 重量	Load on front axle (kg) 前轴轴荷	Load on rear axle (kg) 后轴轴荷
Basic machine 主机		45400	23800	21600
Remove 移除	Counterweight 配重	6400	-2600	9000
	Fixed jib 副臂	1100	1840	-740
	Aux. boom nose 臂尖滑轮	60	180	-120
	Main hook 主钩 (65t)	550	810	-260
	Auxiliary hook 副钩 (6.5t)	140	200	-60

## Carrier Frame

车架底盘



Inverted trapezoidal variable cross section frame is 5% less in weight and 10% stronger in rigidity.

倒梯形变截面车架，实现车架减重 5% 的同时，刚性提升 10%。

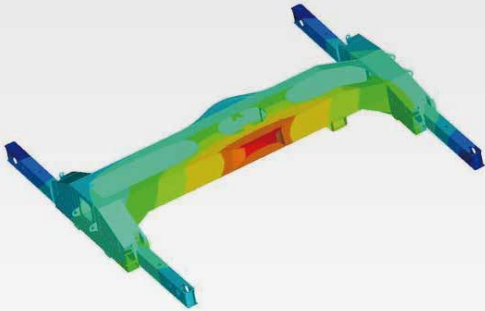

↓ 5%  
Weight 重量

↑ 10%  
Rigidity 刚性

# Power Train

## 动力系统

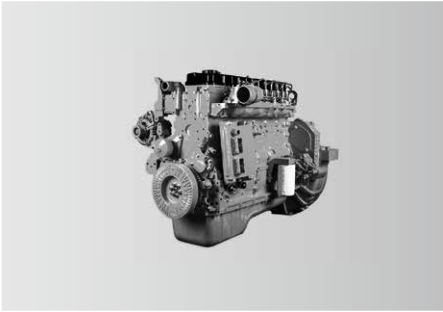

### Engine

Power comes from a DF Cummins QSB6.7 inline six-cylinder water-cooled, turbocharged and intercooled off-highway diesel engine, complying with Stage III emission standard.  
 Rated power: 194kW/2400rpm.  
 Max. torque: 990N·m/1500rpm.

### 发动机

东风康明斯 QSB6.7 三阶段非道路直列六缸水冷、增压中冷柴油发动机。  
 额定功率 :194kW/2400rpm。  
 最大扭矩 :990N·m/1500rpm。

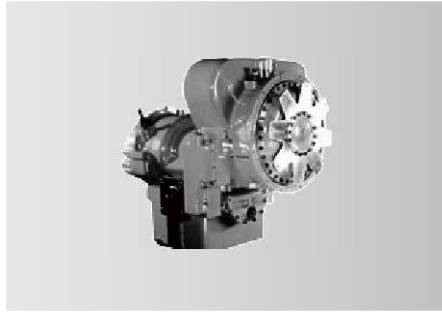

### Transmission

Dana electronically controlled auto transmission features 6 speeds forward and 6 speeds reverse, wide ratio range, and smooth gearshift with reduced maintenance cost.

### 变速箱

德纳全自动电控变速箱,6 个前进挡、6 个后退挡,速比范围大,换挡平顺无冲击,维修保养成本低。

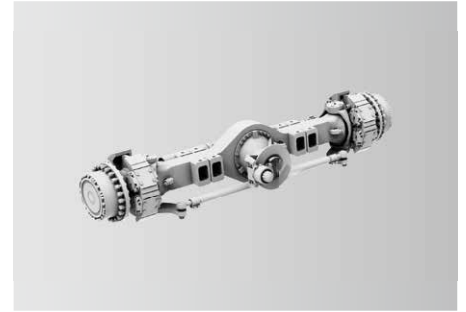

### Axle and suspension

Meritor axles, both axles are driven and steered. Front axle is mounted to the frame by independent steel plate, and rear adopts oscillation cylinders with hydraulic lockout. Driving comfort and lateral stability is therefore guaranteed on rough terrains and conditions.

### 车桥悬挂

美驰车桥,前后桥均为驱动桥和转向桥。前桥采用独立式钢板连接,后桥采用摆动支架式,液压油缸闭锁悬架系统;能适用各种恶劣工况和路面,保证车辆行驶的平顺性和侧翻稳定性,驾驶舒适。

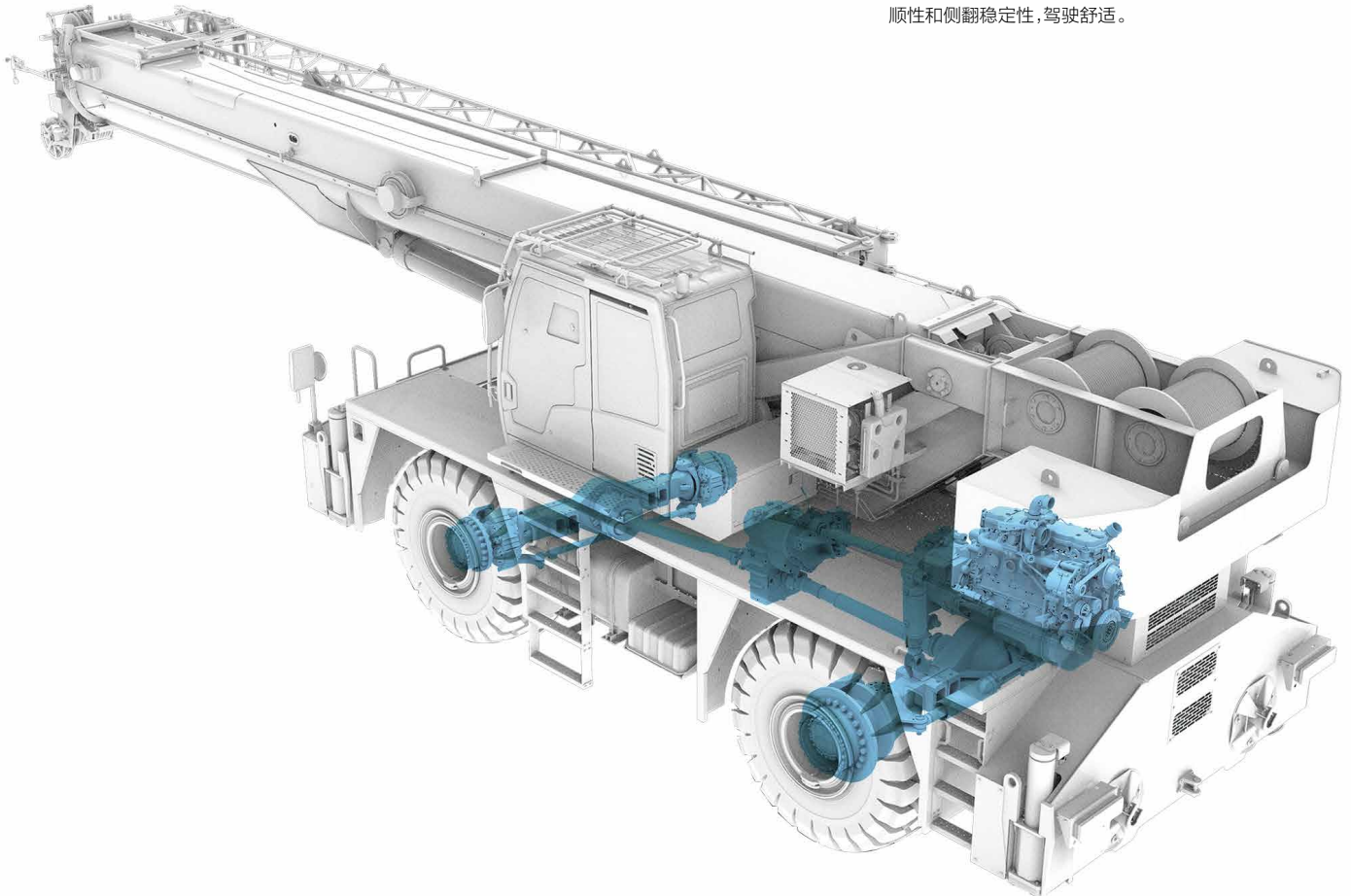

# Electrical System

## 电气系统

### Smart CAN-BUS communication system

International advanced CAN-BUS data communication network applied for display, instrument panel, I/O module, joysticks and main sensors, allowing for high-speed data transmission and quick response in less than 20ms.

### Cabling

Centralized electric cabinet and heavy-duty connector applied for cabling of superstructure, convenient for maintenance; IP rating up to 67, ensuring high reliability.

### Winch camera (optional)

Winch cameras equipped for monitoring its working condition and identifying rope disorder in time.

### Integrated bus button panel input

Various operating states displayed by button indicator lights, and one-button multi-functional operation realizable by writing various operation modes.

### 智能总线通信系统

国际先进的分布式集成总线数据通信网络，显示器、显示仪表、I/O 模块、操作手柄、主要传感器等采用 CAN 总线组网，高速信息传输、响应速度小于 20ms。

### 电缆布线

上车电缆布线采用集中式分线盒及重载接插件，维护方便；防护等级 IP67，可靠性高。

### 卷扬监控系统(选配)

卷扬摄像头监视卷扬工作及及时发现乱绳的情况。

### 集成总线按键面板输入

可通过按键指示灯显示各种工作状态，通过写入多种操作模式实现一键多功能。



Centralized electric cabinet  
集中式电控箱



Anti-two-block switch  
高度限位器



Third wrap indicator  
三圈保护器



Cable reel  
电缆卷筒



Anemometer (optional)  
风速仪(选配)

### Multi-functional screen

Large 10.1 inch HD touch screen display with all new interface. Incorporated crane setup, load charts, working conditions, working period, virtual wall, Bluetooth, radio and diagnostics with an additional navigation knob.

### Precise load moment indicator

SANY independently developed LMI, accuracy of 0 ~ 5%.

### 高新多功能显示屏

采用 10.1 寸高清显示屏, 全新操作界面, 可实现触摸与旋钮多种方式操控。工况、力矩、发动机、变速箱、控制器 IO 点、工作时间统计等丰富的设备状态信息呈现, 集成虚拟墙、蓝牙、收音机等多种扩展功能。

### 精准力矩器系统

三一自主研发的力矩限制器系统, 精度达 0~5%。

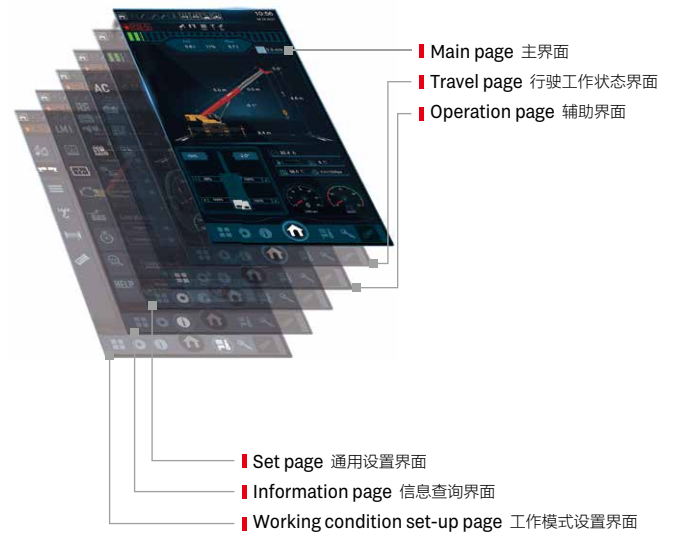

## MachineLink<sup>+</sup>

ROOTCLOUD T-AMS Pro device comes as standard to realize GPS trajectory, machine status, maintenance management, E-fence, alarm management, and operator management on computer or mobile MachineLink+ platform, by remote control of cranes. This telematics package greatly boosts efficiency of customer fleet management and helps provide better after-sales services.

标配树根物联终端 T-AMS Pro, 通过对起重机设备的远程控制, 在电脑或移动端 MachineLink+ 平台实现轨迹回放、设备状态、维保设备、电子围栏、报警管理、操作手管理等功能, 极大提高客户设备管理效率, 提升三一售后服务能力。

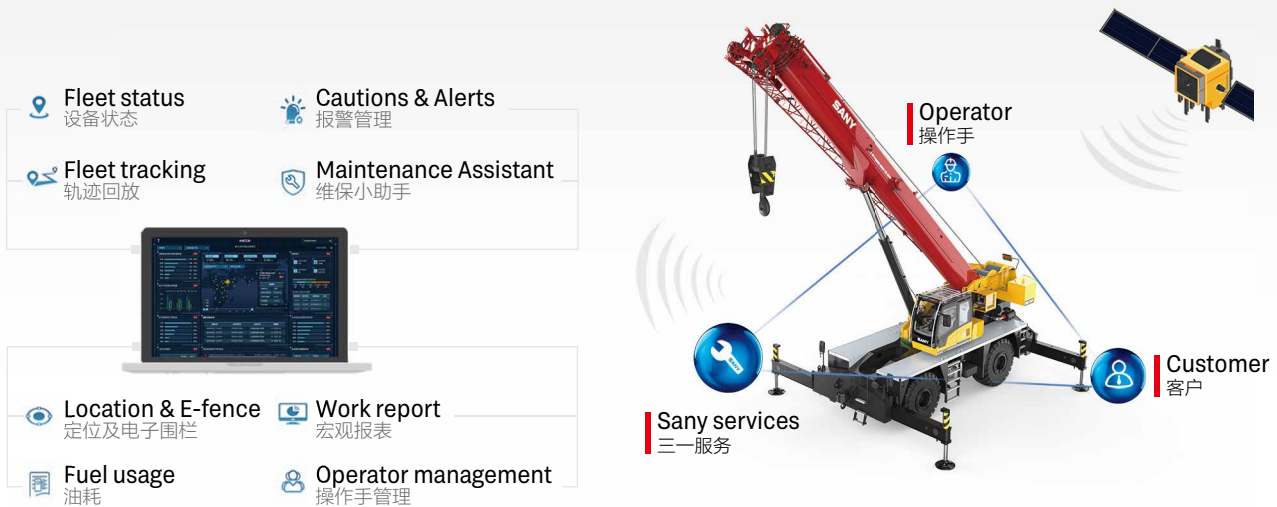

## Hydraulic System

### 液压系统

Five boom sections extended by double cylinder with rope arranger, 2nd boom extended by cylinder I, 3rd ~5th sections telescoped by cylinder II with rope pull. Synchronized telescoping of variable lengths for more applications with higher efficiency.

5 节主臂, 双缸绳排, 一节油缸和钢丝绳伸 2 节臂, 2 节油缸和钢丝绳伸 3、4、5 节臂, 可实现同步伸缩, 臂长任意组合, 省时省力。



## Superstructure

### 上车

Open-type electronically controlled load-sensing system and dynamic slewing brake system.

Electro proportional compensated passive luffing-down system applied to control the luffing speed, making luffing more reliable and stable.

Dynamic slewing brake realizing precise control of slewing speed.

Electronically controlled load-sensing hydraulic system, electronic joystick and electronic throttle, ensuring easy operation and more accurate control and millisecond-level action response speed, with min. single-rope hoisting speed 0.8m/min, and distribution difference in case of combined motions 8%.

通过开式电控负载敏感系统和动态回转制动系统；

电比例自重落幅系统控制落幅速度, 更可靠更平稳；

具备动态回转制动功能, 可实现回转速度精准控制；

电控负载敏感液压系统, 采用电手柄、电油门控制, 轻松操作的同时, 控制更精准；动作响应毫秒级速度；卷扬单绳最低速度 0.8m/min；复合动作分配误差 8%。

## Chassis

下车

### Steering system

A gear pump installed to supply oil for hydraulic steering, steering pressure controlled by electro-proportional relief valve, four steering modes realized by solenoid directional valve.

### Suspension system

Different modes including normal driving and Pick & Carry with suspension locked, suspension to be locked when the crane is working.

### Outrigger telescoping system

The electro proportional relief valve identifies pressure staging of outrigger telescoping, satisfying operation requirements under high pressure and forming protection under limited pressure.

### 转向系统

液压转向系统采用齿轮泵提供油源,通过电比例溢流阀精确控制转向压力,通过电磁换向阀实现前轮转向,后轮转向,全轮转向和蟹行转向共计四种转向模式。

### 悬挂系统

悬挂系统通过选择不同的悬挂模式可以实现正常行驶和锁定模式下的带载行驶;在起重机上车作业时能够对悬挂进行锁定。

### 支腿伸缩系统

支腿伸缩采用电比例溢流阀对支腿伸缩进行压力分级,既满足高压动力动作需求,也可满足限压保护功能。

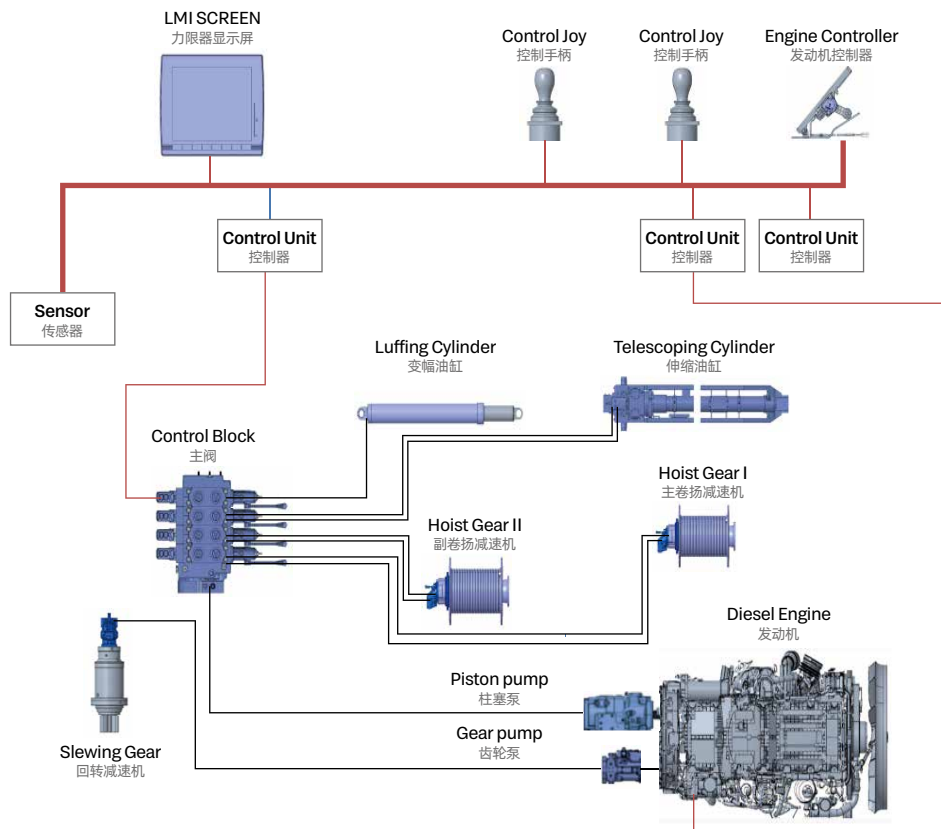



# Overall Dimensions

整机尺寸

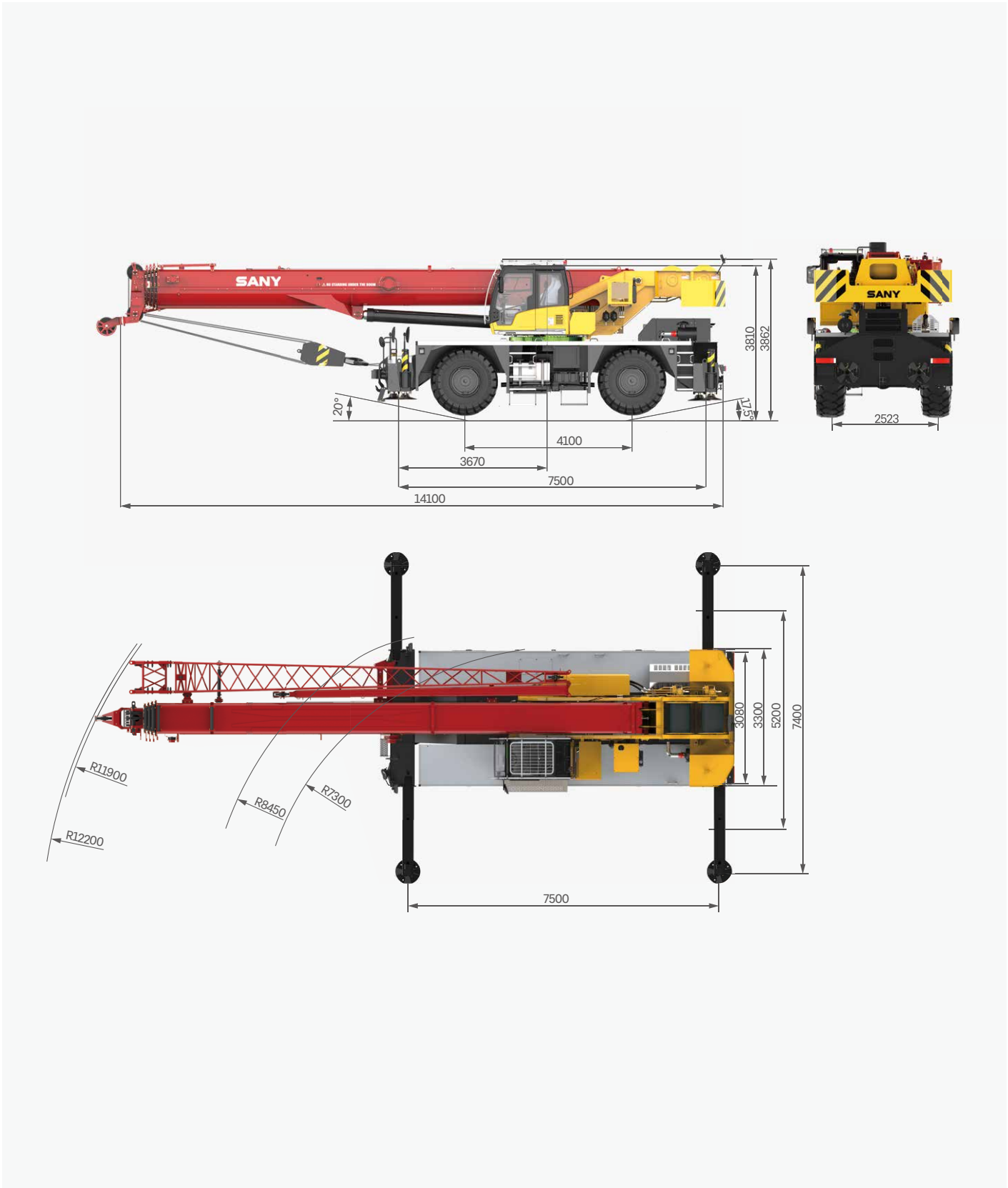

# Technical Specification

## 整机参数

CATEGORY 类型	ITEM 项目	UNIT 单位	VALUE 参数	
CAPACITY 额定起重量	Max. lifting capacity 最大起重量	t	65	
WEIGHT 重量参数	Gross weight 整机总质量	kg	45400	
POWER 发动机参数	Engine model 发动机型号	-	QSB6.7 (stage III)	
	Max. engine power 发动机最大功率	kW/rpm	194/2400	
	Max. engine torque 发动机最大输出扭矩	N·m/rpm	990/1500	
DIMENSIONS 尺寸参数	Overall length 整机全长	mm	14100	
	Overall width 整机全宽	mm	3300	
	Overall height 整机全高	mm	3862	
TRAVEL 行驶参数	Max. travel speed 最高行驶速度	km/h	36	
	Steering radius 转弯半径	Min.steering radius 最小转弯半径	m	13.3/7.3
	Wheel formula 车轮模式	-	4 × 2; 4 × 4	
	Min.ground clearance 最小离地间隙	mm	530	
	Approach angle 接近角	°	20	
	Departure angle 离去角	°	17.5	
	Max.gradeability 最大爬坡度	-	75%	
	Fuel consumption per 100km 每 100 公里油耗	L	85	
MAIN PERFORMANCE 主要性能参数	Working temperature range 使用温度区间	℃	-20~+51	
	Min.rated lifting radius 最小额定幅度	m	3	
	Tail slewing radius 转台尾部回转半径	m	4.45	
	Boom sections (Qty.) 臂节数	-	5	
	Boom shape 臂形状	-	U shape U 形	
	Max.lifting moment 最大起重力矩	Basic boom 基本臂	kN·m	2302
		Full-extension boom 全伸主臂	kN·m	1144
		Full-extension boom + jib 全伸主臂 + 副臂	kN·m	500
	Boom length 臂长	Basic boom 基本臂	m	11.7
		Full-extension boom 全伸主臂	m	45.5
		Full-extension boom + jib 全伸主臂 + 副臂	m	61.5
	Max.lifting height 最大起重高度	Basic boom 基本臂	m	12.3
		Full-extension boom 全伸主臂	m	46
Full-extension boom + jib 全伸主臂 + 副臂		m	62	
Outrigger span (Longitudinal × Transverse) 支腿跨距 (纵 × 横)	m	7.5 × 7.4		
Jib offset 副臂安装角度	°	0, 15, 30		
AIRCONDITIONER 空调	In operator's cab 上车空调	-	Heating & cooling 制冷、制热	

# Technical Specification

## 整机参数



Hook 吊钩

Rated load 额载 /t	Number of sheaves 滑轮数量	Rope rate 倍率	Hook weight/kg 吊钩重量
65	6	12	550
6.5	-	1	140



Operations 主要动作参数

Item 项目	Max.single rope lifting speed (empty load) 单绳速度 (空载)	Rope diameter/length 钢丝绳直径 / 长度	Max. single line pull 最大单绳拉力
Main winch 主卷扬	145m/min	Φ18mm/220m	5.2t
Auxiliary winch 副卷扬	125m/min	Φ18mm/130m	5.2t
Slewing speed 回转速度	2r/min		
Full luffing up/down time of boom 主臂起落幅时间	55s/75s		
Full extension/retraction time of boom 主臂伸缩时间	120s/130s		
Outrigger jack 垂直支腿	Extend 伸	35s	
	Retract 缩	40s	
Outrigger beam 水平支腿	Extend 伸	30s	
	Retract 缩	35s	

# Crane Introduction

## 整机介绍

Carrier 下车

### Carrier frame 车架

- Double longitudinal beam construction welded by high strength steel plate, higher bearing capacity.
- 车架为高强度钢板焊接而成的双纵梁结构，承载能力强。

### Engine 发动机

- Model: QSB6.7 inline six cylinder, direct injection diesel, 4 cycle, turbo charged and after cooled.
- Rated Power: 194kW/2400rpm.
- Emission standard: stage III.
- Fuel reservoir capacity: 350L.
- 型号: QSB6.7 直列六缸、水冷却、增压中冷、4 冲程循环、柴油发动机。
- 额定功率: 194kW/2400rpm。
- 排放标准: 符合 III 阶段。
- 油箱容积: 350L。

### Transmission 变速箱

- DANA automatic gearbox, 6 forward and 6 reverse speeds (3 speeds high and 3 speed low).
- 德纳自动变速箱，6 个前进挡，6 个后退挡，（3 挡高速，3 挡低速）。

### Axle 车桥

- Front Axle: Drive/steer with differential and planetary reduction, service and parking brake.
- Rear Axle: Drive/steer axle with differential and planetary reduction, service brake.
- 前桥: 驱动转向，行星减速机，配有轮间差速锁，行车和驻车制动。
- 后桥: 驱动转向，行星减速机，配有轮间差速锁，行车制动。

### Suspension system 悬挂

- Front Suspension: Rigid mounted to frame.
- Rear Suspension: Pivot mounted with hydraulic lockout device.
- 前桥刚性连接，后桥带油缸锁定枢轴摆动悬挂。

### Tires 轮胎

- Bias ply tires sized 26.5-25.
- 26.5-25 斜交胎。

### Brake 制动系统

- Full hydraulic double-circuit brake system. Service brake on all wheels, parking brake on front wheels.
- 双回路液压制动，行车制动作用于前后轮，驻车制动作用于前轮。

### Outrigger 支腿

- H-type telescoping outrigger, 4-point support, with span (longitudinal × transverse) 7.5m × 7.4m.
- 采用 H 形伸缩支腿，4 点支撑，纵、横跨距 7.5m × 7.4m。

### Steering 转向系统

- Full hydraulic independent power steering. Steering type: front wheel, rear wheel, four wheel and crab.
- 独立液压助力转向，四种转向模式：前轮，后轮，全轮，蟹型。

# Crane Introduction

## 整机介绍

superstructure 上车

### Operator's cab 操纵室

- New generation T-series operator's cab features curved-rail sliding door, safety glass and corrosion resistant steel construction with softened interior trim. Large internal space with panoramic skylight, adjustable seat and other user-friendly design incl. A/C, electric wiper, making it more comfortable and easier to work. The LMI screen is equipped to realize the logic integration of the control console and the display, so that all working data can be seen at a glance.
- 全新一代 T 系列操纵室，带变轨滑移门，配备安全玻璃，耐腐蚀钢板，配置软化内饰、超大内部空间、可调式座椅等人性化设计，配有空调、电动雨刮器，操作更舒适、轻松；配置力矩限制器显示屏，实现主控台与操作显示系统有机结合，使吊装作业的全部工况数据一目了然。

### Boom system 臂架系统

- Boom: Five-section, basic boom 11.7m, full-extension 45.5m, made of high-strength welded structural steel with U-shape cross-section.
- Jib: Two-stage, 9.2m/16m, offset at 0°, 15°, 30°.
- 主臂：五节臂，基本臂 11.7m，全伸臂 45.5m，由高强度焊接结构钢制成，U 形截面。
- 副臂：两节副臂，分别为 9.2m 和 16m，安装角度为 0°，15°，30°。

### Slewing platform 转台结构

- SANY independently developed, made of fine grain high strength steel in optimized structure.
- 三一自主设计，结构更优化，由细晶粒高强度钢制成。

### Hydraulics 液压系统

- Load sensing variable piston pump can adjust displacement in real time to achieve high precision flow control, greatly reducing energy loss.
- Winch adopts electronically controlled variable motor with high operation efficiency. Max. single rope speed of main winch is 145m/min, and auxiliary winch 125m/min.
- Slewing system integrating slewing buffer and free swing technology, start & brake process is smoother and the inching motion performance is ever better.
- 采用负载敏感变量柱塞泵，能实时调节油泵排量，实现高精度的流量控制，极大的降低能量损耗。
- 卷扬采用电控变量马达，作业效率高；主卷扬单绳速度最大达 145m/min，副卷扬单绳速度最大达 125m/min。
- 回转系统带集成回转缓冲阀，具有自由滑转功能，回转启动和控制平稳，微动性卓越。

### Hoist 起升机构

- Main winch and aux. winch adopt planetary reduction with variable displacement motor, featuring high speed and low speed control. Non-rotation high strength wire rope is used.
- 主副卷扬采用行星减速机和变量马达，分高低速控制。配备防旋转高强度钢丝绳。

### Luffing system 变幅系统

- Double acting single rod hydraulic cylinder with holding valve, luffing angle: -2°~80°. Passive luffing down, reducing energy consumption, improving luffing stability.
- 双作用单活塞杆液压缸，带安全平衡阀，变幅角度：-2°~80°，采用自重落幅系统，降低能耗，提高落幅操作的平稳性。

### Slewing 回转系统

- 360° slewing in both directions, max. speed 2r/min. It adopts hydro proportional speed control for stable movement and system reliability. Slewing balance valve fitted to ensure smooth braking.
- 360° 转动，最大回转速度 2r/min。液控比例调速控制，动作稳定，系统可靠。回转缓冲设计，制动更平稳。

### Counterweight 配重

- Fixed block 6.7t.
- 固定配重 6.7t。

### Safety equipment 安全装置

- Load moment indicator: Analytical mechanics is applied and moment limiter calculation system based on the hoisting mechanics model is established. Through online empty-load calibration, the rated accuracy can reach 0-5% to fully protect the hoisting operation. In case of overload, the system will automatically give an alarm to guarantee safety operation.
- The hydraulic system includes balance valve, relief valve, and two-way holding valve to realize system stability and reliability.
- The main and auxiliary winches are equipped with third-wrap indicators to prevent over-hoist-down of the wire rope.
- Boom head and jib head are equipped with A2B switches to prevent the wire rope from over winding.
- The length & angle sensor and pressure sensor are equipped to signify working status in real time, automatically stopping hazardous actions with buzzer alarm.
- 力矩限制器：采用分析力学方法，建立了基于吊重力学模型的力矩限制器计算系统，通过在线空载标定，额定吊重精度达到 0-5%，全方位保护吊载作业；超载作业时，系统自动报警提示，为操纵作业提供安全保障。
- 液压系统配置平衡阀、溢流阀、双向液压锁等元件，实现液压系统稳定可靠。
- 主、副卷扬配置三圈保护器，防止钢丝绳过放。
- 主、副臂臂端配置高度限位器，防止钢丝绳过卷。
- 配置长度角度传感器、压力传感器，实时显示起重机作业状态，自动切断危险动作，蜂鸣报警。

### Optional equipment at extra fees 选配

- Anemometer / Winch camera / Boom tip camera / Reversing camera / Reversing radar / Air intake shutoff valve / Spark arrester / Slewing buzzer / Navigation beacon / 29.5-25 tires / Desert tires / Inflator / Customized painting.
- Other equipment available upon request.
- 风速仪 / 卷扬摄像头 / 臂头摄像头 / 倒车摄像头 / 倒车雷达 / 进气切断阀 / 火星灭火器 / 回转蜂鸣器 / 航标灯 / 29.5-25 轮胎 / 沙漠胎 / 打气泵 / 特殊涂装。
- 其他选配视需求定。

# Working Conditions

工况组合



Telescopic boom on outriggers  
主臂、支腿吊载

Fixed jib on outriggers  
固定副臂、支腿吊载

Telescopic boom on tires  
主臂、轮胎吊载

# Operating Range - Telescopic Boom

## 起升高度曲线 - 主臂

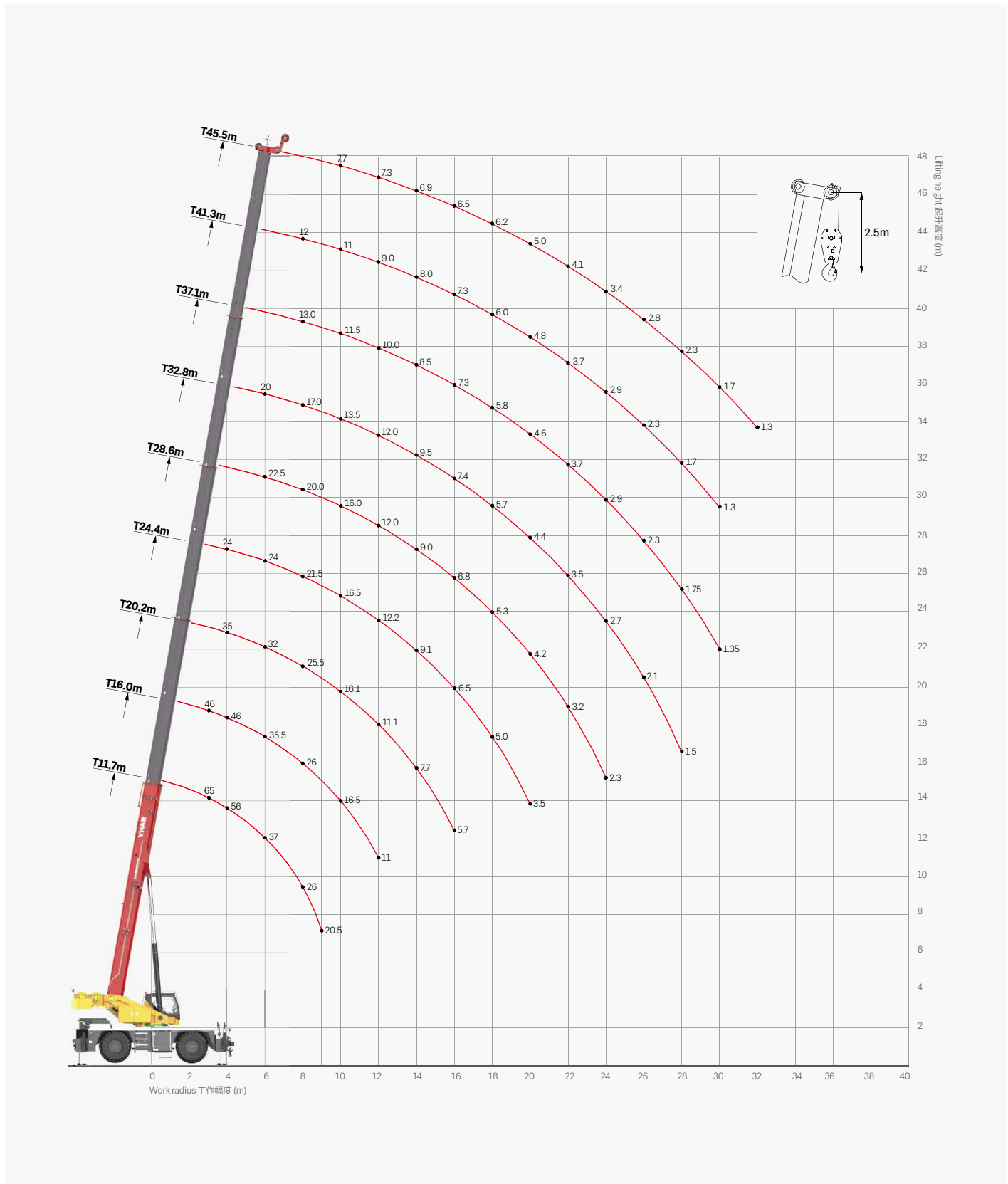















# Load Chart-Telescopic Boom

## 性能表 - 主臂

Unit: kg



	11.7m	16.0m	20.2m	24.4m	28.6m	32.8m	37.1m	41.3m	45.5m	
3.0	65000*	46000								3.0
3.5	59000	46000	36000							3.5
4.0	56000	46000	35000	24000						4.0
4.5	52200	44000	34000	24000						4.5
5.0	46000	42000	33000	24000	22500					5.0
5.5	41000	39000	32000	24000	22500					5.5
6.0	37000	35500	32000	24000	22500	20000				6.0
6.5	34000	32200	30500	24000	22500	19500	16000			6.5
7.0	31000	30000	29000	24000	22500	19000	15000			7.0
7.5	29000	28000	27500	23000	21500	18000	14000	12000		7.5
8.0	26000	26000	25500	21500	20000	17000	13000	12000		8.0
8.5	23000	24000	22500	20500	19000	16000	12500	12000	9500	8.5
9.0	20500	20500	19700	18500	18000	15000	12000	11500	9300	9.0
10.0		16500	16100	16500	16000	13500	11500	11000	9000	10.0
12.0		11000	11100	12200	12000	12000	10000	9000	8500	12.0
14.0			7700	9100	9000	9500	8500	8000	8000	14.0
16.0			5700	6500	6800	7400	7300	7300	7300	16.0
18.0				5000	5300	5700	5800	6000	6200	18.0
20.0				3500	4200	4400	4600	4800	5000	20.0
22.0					3200	3500	3700	3700	4100	22.0
24.0					2300	2700	2900	2900	3400	24.0
26.0						2100	2300	2300	2800	26.0
28.0						1500	1700	1700	2300	28.0
30.0							1300	1300	1700	30.0
32.0									1300	32.0
34.0										34.0
 2#	0%	50%	100%	100%	100%	100%	100%	100%	100%	2#
 3#	0%	0%	0%	17%	33%	50%	67%	83%	100%	 3#
 4#	0%	0%	0%	17%	33%	50%	67%	83%	100%	 4#
 5#	0%	0%	0%	17%	33%	50%	67%	83%	100%	 5#
	13	10	8	6	6	4	4	4	3	
	0°	0°	0°	0°	0°	23°	29°	38°	40°	
	14000	6000	3000	1500	1000	800	800	800	800	









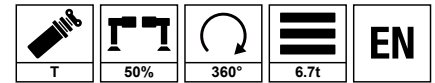

# Load Chart-Telescopic Boom

## 性能表 - 主臂

Unit: kg



	11.7m	16.0m	20.2m	24.4m	28.6m	32.8m	37.1m	41.3m	45.5m		
3.0	55000	42000								3.0	
3.5	50000	40000	33000							3.5	
4.0	45000	38000	31000	22500						4.0	
4.5	40000	34000	29000	21000						4.5	
5.0	35000	31000	27000	20000	21000					5.0	
5.5	28000	26000	24000	19000	20000					5.5	
6.0	23000	22000	21000	18000	18500	17000				6.0	
6.5	20000	18000	18000	17000	17500	16000	14000			6.5	
7.0	17000	16000	16000	16000	16000	15000	13000			7.0	
7.5	15000	13800	14000	14000	14500	14000	12000	11000		7.5	
8.0	13000	12000	12500	12500	13000	13000	11000	10500		8.0	
8.5	11500	10500	11000	11000	11500	12000	10500	10000	8000	8.5	
9.0	10000	9500	9500	10000	10000	11000	9500	9500	7500	9.0	
10.0		7500	8000	8000	8300	9000	8500	8500	7000	10.0	
12.0		4500	5000	5500	5600	6000	6000	6000	6000	12.0	
14.0			3500	3800	4000	4200	4300	4500	4500	14.0	
16.0			2300	2600	2800	3000	3100	3300	3300	16.0	
18.0				1600	1800	2200	2300	2500	2500	18.0	
20.0						1500	1700	1800	1900	20.0	
22.0									1400	22.0	
24.0										24.0	
	2#	0%	50%	100%	100%	100%	100%	100%	100%	100%	2#
	3#	0%	0%	0%	17%	33%	50%	67%	83%	100%	3#
	4#	0%	0%	0%	17%	33%	50%	67%	83%	100%	4#
	5#	0%	0%	0%	17%	33%	50%	67%	83%	100%	5#
	12	8	8	6	6	4	4	4	3		
	0°	0°	0°	35°	45°	47°	52°	56°	57°		
	8000	2000	1000	800	800	800	800	800	800		

# Load Chart-Telescopic Boom

## 性能表 - 主臂

Unit: kg



m	11.7m	16.0m	20.2m	24.4m	28.6m	32.8m	37.1m	41.3m	45.5m	m	
3.0	35000	30000								3.0	
3.5	27000	25000	25000							3.5	
4.0	20000	19000	20000	19000						4.0	
4.5	16000	16000	15500	16000						4.5	
5.0	13000	13000	13000	13000	12000					5.0	
5.5	11500	11000	11000	11000	10000					5.5	
6.0	10000	9000	9000	9000	8000	10000				6.0	
6.5	8500	8000	7500	8000	7000	9000	9000			6.5	
7.0	7500	7000	6500	7000	6000	8000	8000			7.0	
7.5	6500	6000	5600	6000	5200	7000	7000	7000		7.5	
8.0	5500	5000	5000	5000	4500	6000	6000	6000		8.0	
8.5	4500	4500	4200	4500	4000	5000	5500	5500	5500	8.5	
9.0		4000	3600	4000	3500	4500	5000	5000	5000	9.0	
10.0		3000	2600	3000	2800	3500	3700	4000	4000	10.0	
12.0		1500		1700	1800	2500	2500	2500	2600	12.0	
14.0						1500	1700	1600	1600	14.0	
16.0										16.0	
	2#	0%	50%	100%	100%	100%	100%	100%	100%	100%	2#
	3#	0%	0%	0%	17%	33%	50%	67%	83%	100%	3#
	4#	0%	0%	0%	17%	33%	50%	67%	83%	100%	4#
	5#	0%	0%	0%	17%	33%	50%	67%	83%	100%	5#
	8	6	6	4	4	4	4	4	3		
	0°	30°	53°	54°	59°	60°	63°	66°	68°		
	3000	800	800	800	800	800	800	800	800		
	75°	80°	80°	80°	80°	80°	80°	80°	80°		

### Remark

- Load capacity in the chart is the maximum weight which this crane could hoist include the hook blocks' weight. The main hook weighs 550kg, the aux. hook weighs 140kg.
- Radius shown in the chart is the actual radius when loading.
- The load capacity in the chart is the maximum weight when this crane is supported with the firm ground and stays in level.
- Choose rated load capacity of the longer boom and radius when the actual boom length and radius are between two values in the charts.
- The machine can be used only when the wind power is less than grade 6.
- \* With attachment sheave (When the lifting capacity over 62t).

- 性能表中额定起重量包括起重钩 (主钩重 550kg, 副钩重 140kg) 和吊具的重量。
- 性能表中工作幅度是指吊载后的实际幅度。
- 性能表中给定数值是在平整坚固的地面上, 整机调平状态下起重机的最大起重量。
- 如实际臂长和幅度介于两个数值之间时, 取较长的臂长及较大的幅度所决定的额定起重量进行起重作业。
- 起重作业风力等级需低于 6 级。
- \* 使用附加滑轮 (当吊重超过 62t 时)。

# Operating Range - Fixed Jib

## 起升高度曲线 - 副臂

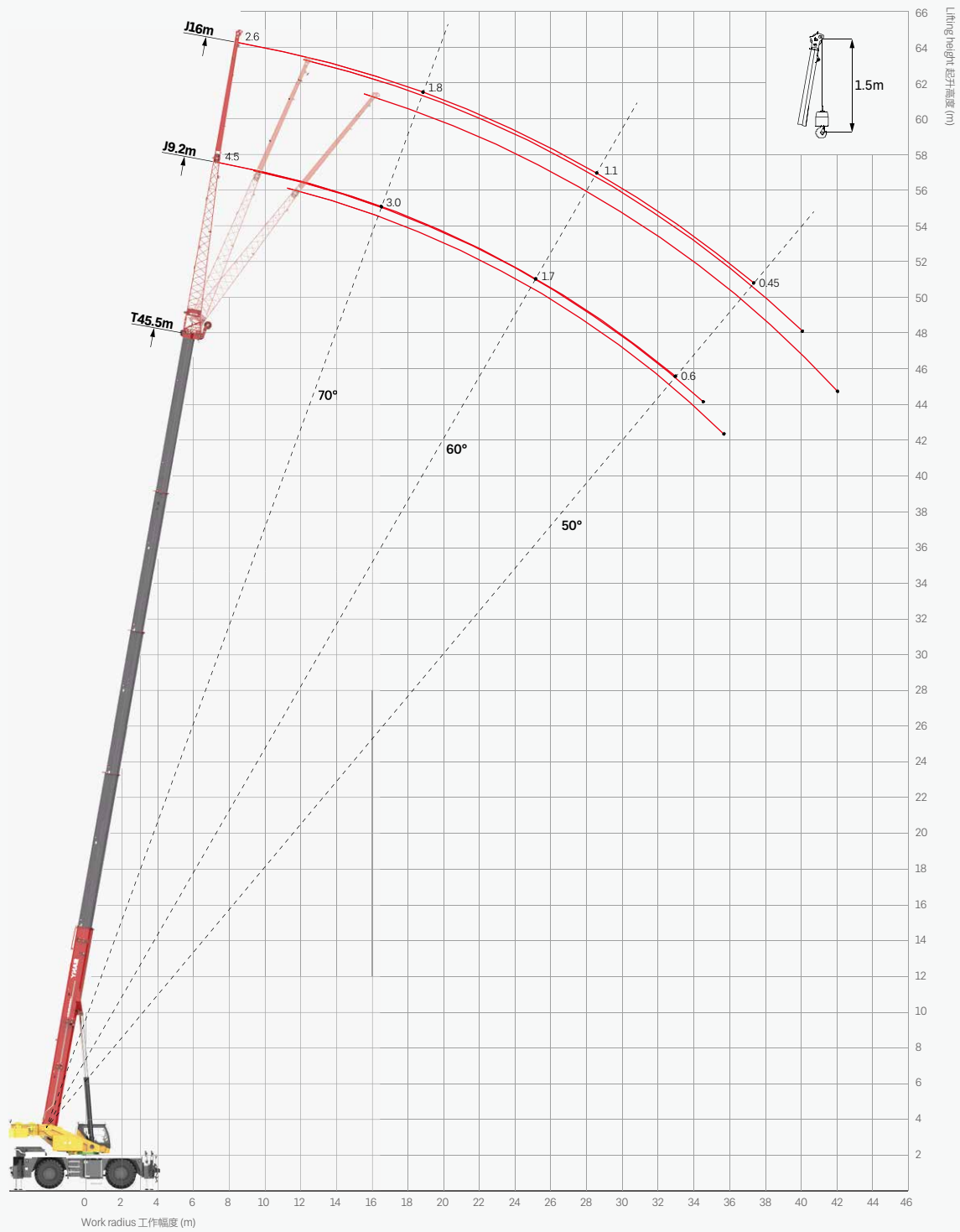





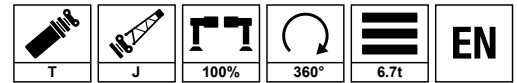

# Load Chart - Fixed Jib

## 性能表 - 副臂

Unit: kg



	45.5m boom + 9.2m jib			45.5m boom + 16m jib			
	0°	15°	30°	0°	15°	30°	
80	4000	2700	2400	2400	1500	1100	80
78	4000	2700	2400	2400	1500	1100	78
76	4000	2500	2300	2400	1400	1100	76
74	3750	2400	2250	2200	1300	1100	74
72	3500	2300	2150	2000	1200	1000	72
70	3000	2200	2050	1800	1150	1000	70
68	2700	2100	1950	1600	1100	950	68
66	2500	2000	1850	1500	1050	900	66
64	2200	1800	1750	1450	1000	850	64
62	2000	1650	1500	1300	950	800	62
60	1700	1450	1200	1100	850	750	60
58	1200	1000	850	900	750	650	58
56	1000	850	750	800	650	600	56
54	800	700	600	700	600	500	54
52	700	600	550	600	500	400	52
50	600	550	500	450	350	300	50
	49°						
	400	350	300	250	200	200	

# Load Chart - Telescopic Boom, Pick & Carry, Load Over Front

## 性能表 - 主臂帶載行駛 (正前方)

Unit: kg











	11.7m	16.0m	20.2m	24.4m	28.6m	
3.0	18000	14000				3.0
3.5	16000	13000	12000			3.5
4.0	14000	12000	11000	11000		4.0
4.5	12500	11000	10000	10000		4.5
5.0	11000	10000	9000	9000	9000	5.0
5.5	10000	9000	8000	8000	8000	5.5
6.0	8500	8000	7000	7000	7500	6.0
6.5	7000	7000	6000	6000	6500	6.5
7.0	6000	6000	5500	5500	6000	7.0
7.5	5000	5000	5000	5000	5500	7.5
8.0	4200	4500	4500	4600	5000	8.0
8.5	3500	4000	4000	4100	4500	8.5
9.0	2800	3500	3600	3700	4000	9.0
10.0		2500	2800	3000	3500	10.0
11.0		2000	2300	2500	2700	11.0
12.0				2000	2200	12.0
	2#	0%	0%	0%	0%	2#
	3#	0%	17%	33%	50%	3#
	4#	0%	17%	33%	50%	4#
	5#	0%	17%	33%	50%	5#
	4	4	4	4	4	
	20°	36°	50°	55°	60°	
	800	800	800	800	800	

# Load Chart - Telescopic Boom, On Tires Stationary, Load Over Front

## 性能表 - 轮胎静止吊载 (正前方)

Unit: kg



	11.7m	16.0m	20.2m	24.4m	28.6m	
3.0	22000	17000				3.0
3.5	21000	16000	15000			3.5
4.0	20000	15000	14000	13000		4.0
4.5	17000	14000	13000	12000		4.5
5.0	14000	13000	12000	11000	11000	5.0
5.5	12000	11000	11000	10000	10000	5.5
6.0	10000	10000	10000	9500	9500	6.0
6.5	8500	9000	9000	9000	9000	6.5
7.0	7000	7500	8000	8000	8000	7.0
7.5	6000	6500	7000	7200	7500	7.5
8.0	5500	5500	6000	6500	6700	8.0
8.5	4500	5000	5000	5500	6000	8.5
9.0	3500	4000	4500	4500	5000	9.0
10.0		3000	3500	4000	4200	10.0
11.0		2000	2500	3000	3500	11.0
12.0				2500	2700	12.0
14.0					2000	14.0
	2#	0%	0%	0%	0%	2#
	3#	0%	17%	33%	50%	3#
	4#	0%	17%	33%	50%	4#
	5#	0%	17%	33%	50%	5#
	6	4	4	4	4	
	0°	36°	50°	54°	55°	
	1500	800	800	800	800	

# Load Chart - Telescopic Boom, On Tires Stationary, 360° Slewing

## 性能表 - 轮胎静止吊载 (360°)

Unit: kg



	11.7m	16.0m	20.2m	24.4m	28.6m		
3.0	12000					3.0	
3.5	11000					3.5	
4.0	10000	10000				4.0	
4.5	8600	8000	8000	6500		4.5	
5.0	7000	6500	6000	5700	5500	5.0	
5.5	5800	5500	5200	5100	5000	5.5	
6.0	4300	4200	4100	4000	4000	6.0	
6.5	3000	3100	3200	3300	3500	6.5	
7.0	2500	2600	2700	2800	3000	7.0	
7.5	2000	2100	2200	2300	2500	7.5	
8.0					2000	8.0	
	2#	0%	0%	0%	0%	0%	2#
	3#	0%	17%	33%	50%	67%	3#
	4#	0%	17%	33%	50%	67%	4#
	5#	0%	17%	33%	50%	67%	5#
	4	4	4	4	4		
	37°	54°	62°	66°	69°		
	800	800	800	800	800		
	70°	73°	75°	78°	79°		

**Remark**

1. Capacities are applicable at 550kPa cold tire inflation pressure.
2. Capacities are applicable only with machine on firm level surface.
3. On tire lifting with the jib mounted is not permitted.
4. Axle lockouts must be applied when lifting on tires.
5. Parking brake must be applied when lifting on tires stationary.
6. Driving speed shall be 4km/h at pick & carry mode.

1. 冷态轮胎气压需保持 550kPa。
2. 起重机需在平整坚固的地面上作业。
3. 轮胎吊载工况不允许使用副臂吊载。
4. 轮胎吊载工况中，车桥悬挂需锁定。
5. 轮胎静止吊载工况中，需使用驻车制动。
6. 带载行驶工况中，直线行驶速度需小于等于 4km/h。



## SANY GROUP CRANE BU

SANY Mobile Crane Industrial Park, No.168 Jinzhou Avenue, Jinzhou Development Zone, Changsha City,  
Hunan Province, P.R. China Zip 410600  
Consulting [sanycrane@sanygroup.com](mailto:sanycrane@sanygroup.com) (Crane BU) / [crd@sany.com.cn](mailto:crd@sany.com.cn) (IHQ)  
After-sales Service 0086-400 6098 318

Reminder:  
Any change in the technical parameters and configuration due to product modification or upgrade may occur without prior notice.  
The machine in the picture may include additional equipment. This brochure is for reference only, and goods in kind shall prevail.  
Copyright at SANY. No part of this brochure may be copied or used for any purpose without written approval from SANY.

© Edited in April 2024

### 三一集团起重事业部

中国湖南长沙金洲开发区金洲大道 168 号三一汽车起重机产业园 邮编: 410600  
咨询: [sanycrane@sanygroup.com](mailto:sanycrane@sanygroup.com) (起重事业部) / [crd@sany.com.cn](mailto:crd@sany.com.cn) (国际总部)  
海外售后服务: 0086-400 6098 318

温馨提示:  
由于技术不断更新, 技术参数及配置如有更改, 恕不另行通知。图中机器可能包括附加设备, 本画册仅供参考, 以实物为准。  
版权为三一所有, 未经三一书面许可, 本画册任何内容不得被复制用于任何目的。

© 2024 年 4 月版

