

SPECIFICATION



120t



60m



18.7m

SRC1200T

SANY ROUGH TERRAIN CRANE

QUALITY CHANGES THE WORLD

www.sanyglobal.com

It is one of the core business units in SANY Group, specializing in the development and manufacturing of high-end wheel cranes, crawler cranes and tower cranes, including the complete range of wheel cranes from 8 to 2400t, crawler cranes from 25 to 4500t and tower cranes from 6 to 185t.

三一集团旗下核心事业部，从事高端轮式起重机、履带起重机、塔式起重机系列产品的研发制造。覆盖8-2400吨全吨位轮式起重机，25-4500吨全吨位履带起重机，6-185吨塔式起重机。



SANY CRANE



SRC1200T

SANY ROUGH TERRAIN CRANE
120T LIFTING CAPACITY

A 120t rough terrain crane with six section 60m boom, stronger capacity yet reduced self-weight. Jib swingout process is controlled hydraulically via remote device in only 15 minutes, allowing quick setup once arriving at jobsite. Key components come from International name brands. Operator comfort is improved by brand new cab design.

一款最大起重量120吨，6节臂，全伸臂长60m的越野起重机，性能强，副臂远程操控，液电辅助15分钟内完成收展，核心部件均为国际知名供应商提供，配备全新操纵室，驾驶、操作舒适度全面升级。



All new operator's cab

Ergonomic concept of safety and comfort

全新操纵室

操作安全、舒适、人机工程全面升级

Auto-swing jib

Swingout/back via remote control

自动化副臂

远程控制完成收展

Self-removable counterweight

Mount and dismount by remote control

自拆装配重

远程遥控装卸

High end key components

DF Cummins engine/Dana transmission/Meritor axles

国际知名供应商

东风康明斯发动机/德纳变速箱/美驰车桥



All New Operator's Cab

全新操纵室

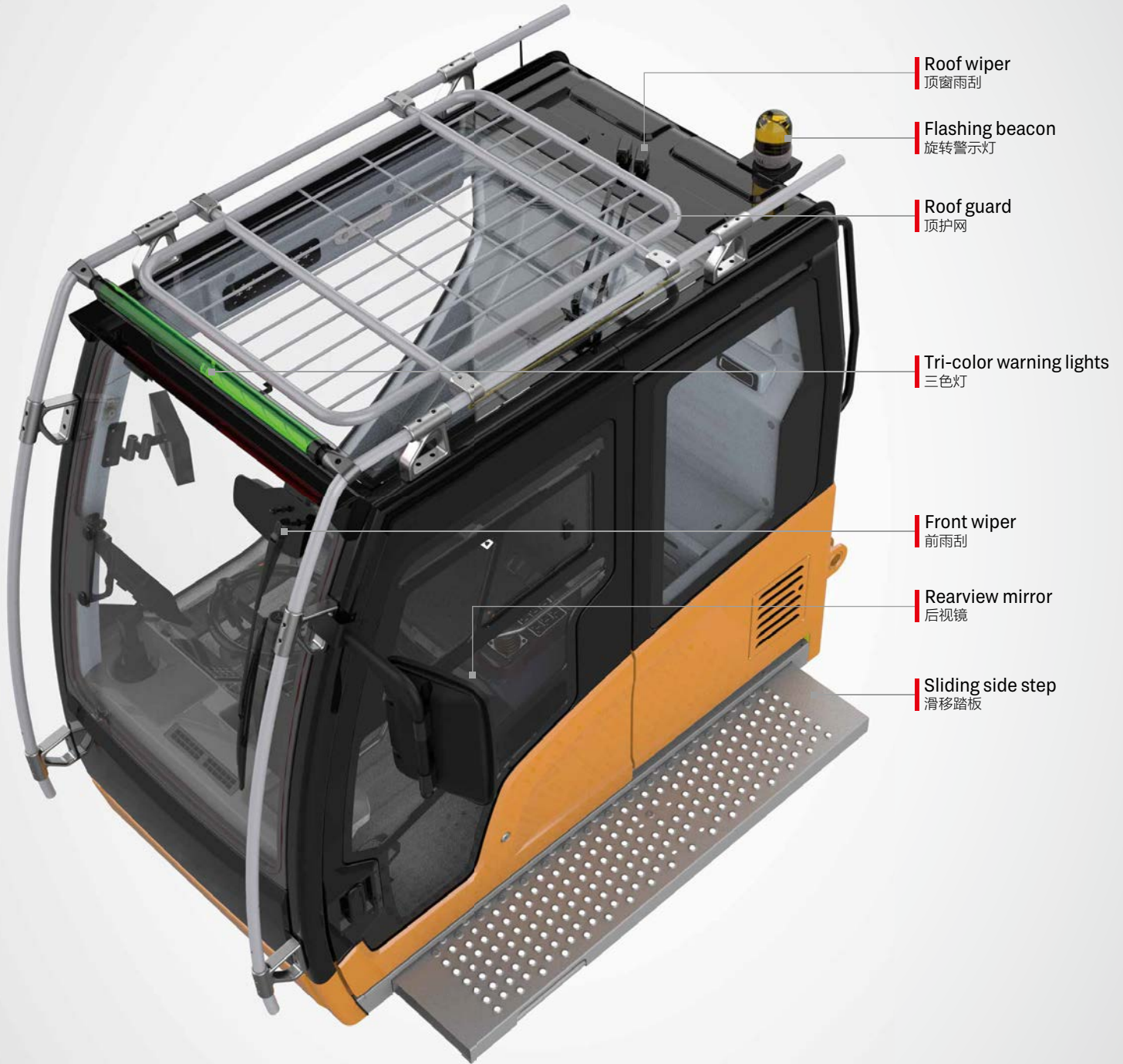

Roof wiper
顶窗雨刮

Flashing beacon
旋转警示灯

Roof guard
顶护网

Tri-color warning lights
三色灯

Front wiper
前雨刮

Rearview mirror
后视镜

Sliding side step
滑移踏板



Safety & Reliability
安全可靠



Comfort & Convenience
舒适便捷



Simplicity & Efficiency
简单高效

SPECIFICATION

Rearview and
winch monitor
卷扬监视器

10.1 inch LMI screen
10.1 吋显示屏

Outrigger control
panel
支腿控制面板

Steering column
方向柱

Pedals
踏板布置

Upper control panel
辅助面板

Emergency stop
switch
急停开关

Bubble level
水平仪

Cup holder
水杯托

Joystick
手柄

Joystick
手柄

Left control panel
左扶手箱控制面板

Right control panel &
LMI navigation knob
右扶手箱控制面板

Armrest
扶手箱

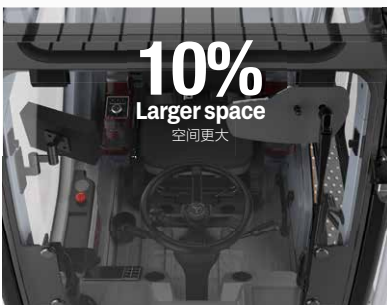
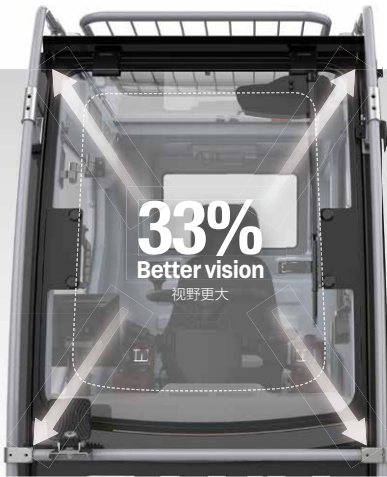

Integrating SUV genes, overall space is enlarged by 10% and forward field of vision is increased by 33%. The front windshield can be opened by 70 degrees, providing better ventilation and a second emergency exit.

融入 SUV 基因, 整体空间增大 10%, 配备超大可开合 70° 前挡风玻璃, 视野提升 33%, 增加空气对流, 并可作为快速逃生通道。



Sliding door transits between tracks when closing to make perfect thermal and acoustical insulation.

侧向变轨, 滑移门完美隔绝外部环境。

Getting in and out is made more convenient with the power sliding side step.

全宽电动伸缩踏板, 超大安全便利进出通道。

SPECIFICATION

Adjustable steering wheel for driving and controlling, modular control panels, and smart user interface deliver intuitive and highly efficient control.

驾控一体的方向盘、模块化控制面板、UI 智能操作界面，操作简单，为高效吊装保驾护航。



Auto-swing Jib 自动副臂系统

Hydraulic power assisted jib deployment, handled by one person with the use of remote controller.

液电辅助收展配合远程控制,单人操作即可完成。



Remote controller
遥控器

- Retraction (L)
收缩
- Extension (R)
伸展
- Retraction (R)
收缩
- Extension (R)
伸展
- Pin out
拔销
- Pin in
插销

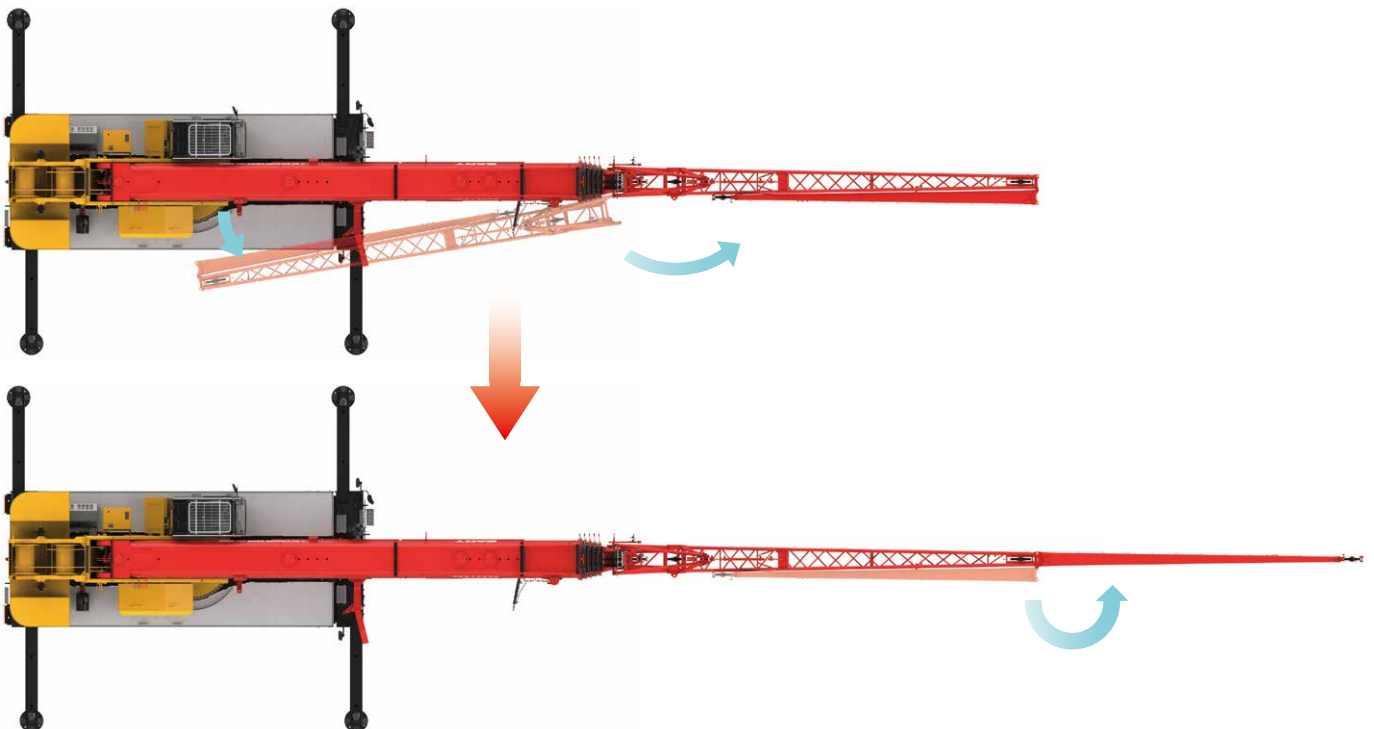
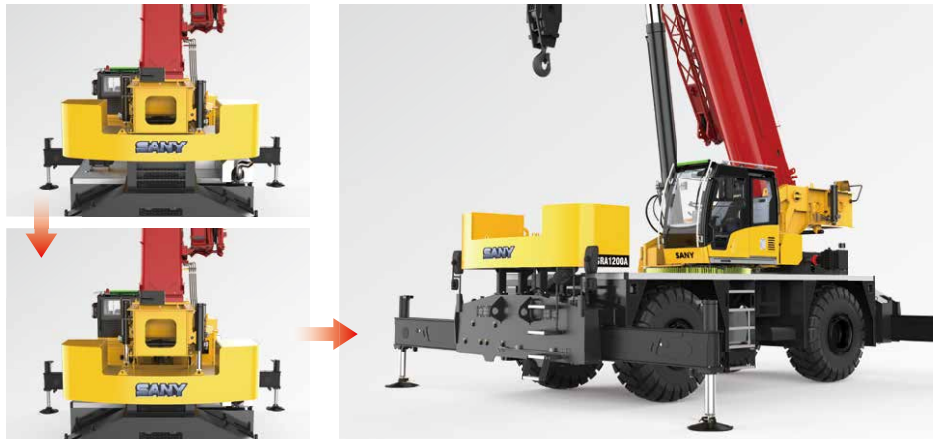

Convenient Transport

行驶运输便捷性

Four Steering Modes

四种转向模型

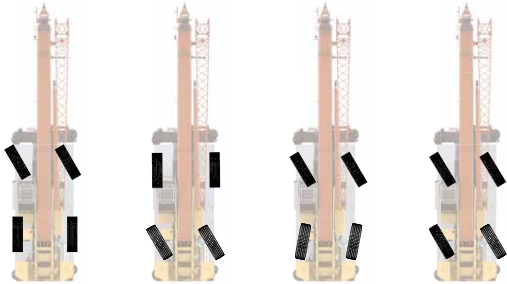

2 wheel front 前轮转向模式

2 wheel rear 后轮转向模式

4 wheel 四轮转向模式

Crab 蟹行模式



Steering control panel
转向控制面板

One-trailer Transport

一车整运

The basic machine is transported at 75.8t with counterweight, jib and hooks, 3.45m wide and 3.94m high, and the basic machine is transported at 58.8t without counterweight, satisfying road regulations.

主机运输尺寸为宽 3.45m,高 3.94m,重量为 75.8t(带配重、副臂和吊钩),拆配重运输重量 58.8t 满足道路运输要求。

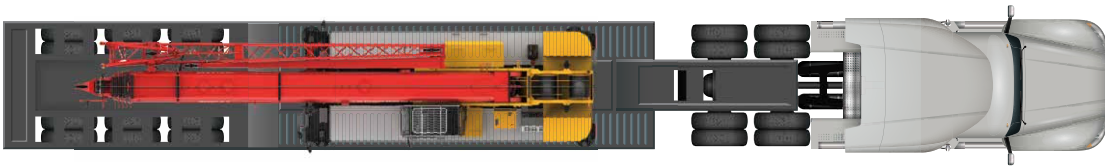

Transport Solution

运输方案

Items 项目		Weight (kg) 重量	Load on front axle (kg) 前轴轴荷	Load on rear axle (kg) 后轴轴荷
Basic machine 主机		75800	39200	36600
Counterweight 配重		-23000	6300	-29300
Fixed jib 副臂		-1750	-4250	2500
Aux. boom nose 臂尖滑轮		-50	-220	170
Main hook 主钩	90t	-830	-2430	1600
Auxiliary hook 副钩	8t	-180	-480	300

Note: boom angle remains 0°
起重臂角度 0°

Carrier Frame

车架底盘

Inverted trapezoidal variable cross section frame is 5% less in weight and 10% stronger in rigidity.

倒梯形变截面车架, 实现车架减重 5% 的同时, 刚性提升 10%。

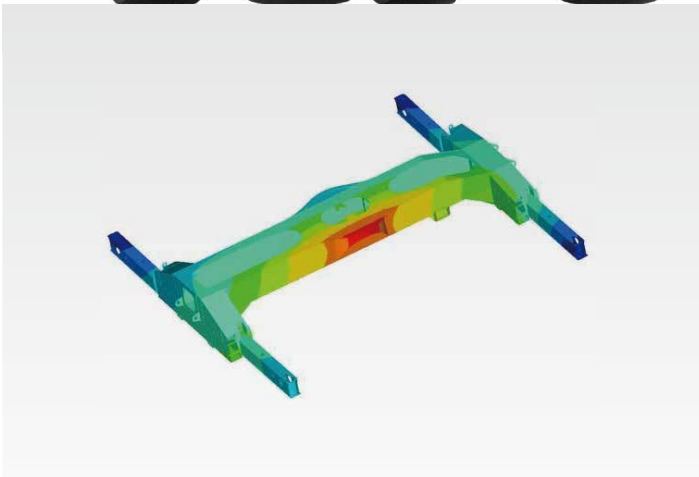

↓ 5%
Weight 重量

↑ 10%
Rigidity 刚性

Power Train

动力系统

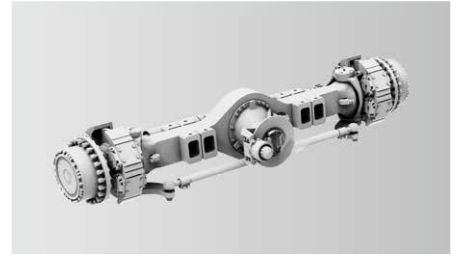
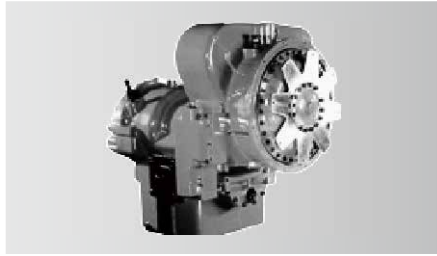
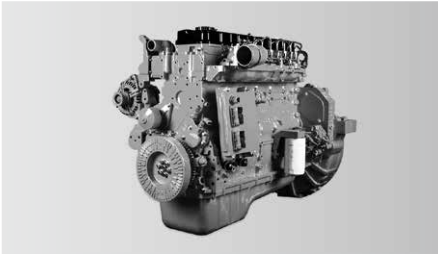

Engine

Power comes from a DF Cummins QSB6.7 inline six-cylinder water-cooled, turbocharged and intercooled off-highway diesel engine, complying with Stage III emission standard.

Rated power: 194kW/2400rpm.

Max. torque: 990N·m/1500rpm.

发动机

东风康明斯 QSB6.7 三阶段非道路直列六缸水冷、增压中冷柴油发动机。

额定功率 :194kW/2400rpm。

最大扭矩 :990N·m/1500rpm。

Transmission

Dana electronically controlled auto transmission features 6 speeds forward and 6 speeds reverse, wide ratio range, and smooth gearshift with reduced maintenance cost.

变速箱

德纳全自动电控变速箱,6个前进挡、6个后退挡,速比范围大,换挡平顺无冲击,维修保养成本低。

Axle and suspension

Meritor axles, both axles are driven and steered. Front axle is mounted to the frame by independent steel plate, and rear adopts oscillation cylinders with hydraulic lockout. Driving comfort and lateral stability is therefore guaranteed on rough terrains and conditions.

车桥悬挂

美驰车桥,前后桥均为驱动桥和转向桥。前桥采用独立式钢板连接,后桥采用摆动支架式;液压油缸闭锁悬架系统;能适用各种恶劣工况和路面,保证车辆行驶的平顺性和侧翻稳定性,驾驶舒适。

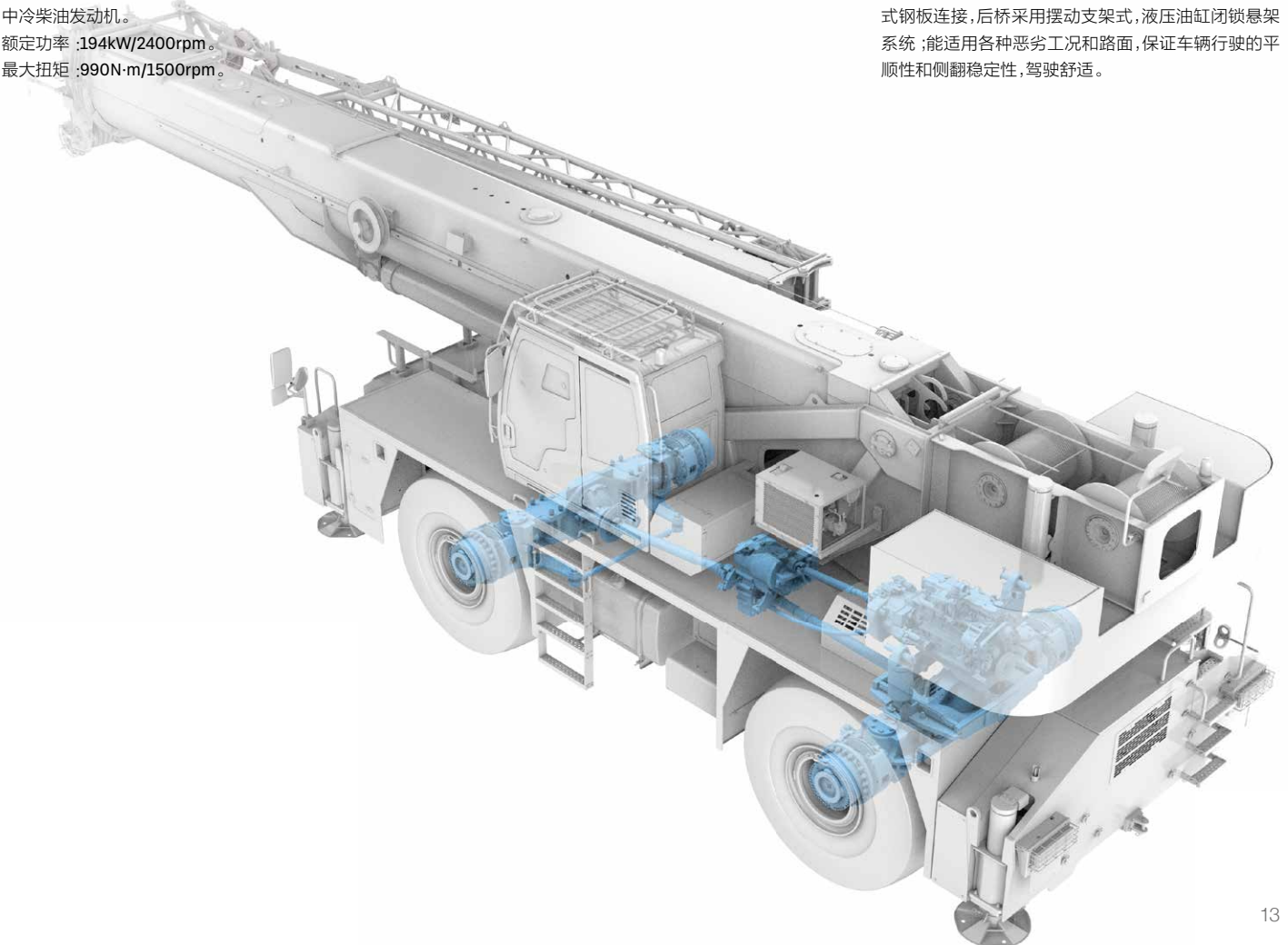

Electrical System

电气系统

Smart CAN-BUS communication system

International advanced CAN-BUS data communication network applied for display, instrument panel, I/O module, joysticks and main sensors, allowing for high-speed data transmission and quick response in less than 20ms.

Cabling

Centralized electric cabinet and heavy-duty connector applied for cabling of superstructure, convenient for maintenance; IP rating up to 67, ensuring high reliability.

Winch camera

Winch cameras equipped for monitoring its working condition and identifying rope disorder in time.

Integrated bus button panel input

Various operating states displayed by button indicator lights, and one-button multi-functional operation realizable by writing various operation modes.

智能总线通信系统

国际先进的分布式集成总线数据通信网络，显示器、显示仪表、I/O模块、操作手柄、主要传感器等采用CAN总线组网，高速信息传输、响应速度小于20ms。

电缆布线

上车电缆布线采用集中式分线盒及重载接插件，维护方便；防护等级IP67，可靠性高。

卷扬监控系统

卷扬摄像头监视卷扬工作及时发现乱绳的情况。

集成总线按键面板输入

可通过按键指示灯显示各种工作状态，通过写入多种操作模式实现一键多功能。



Centralized electric cabinet
集中式电控箱



Anti-two-block limit switch
高度限位器



Third wrap indicator
三圈保护器



Cable reel
电缆卷筒



Cable reel inside the boom
臂内卷筒



Anemometer
风速仪

Multi-functional screen

Large 10.1 inch HD touch screen display with all new interface. Incorporated crane setup, load charts, working conditions, working period, virtual wall, Bluetooth, radio and diagnostics with an additional navigation knob.

Precise load moment indicator

SANY independently developed LMI, accuracy of 0 ~ 5%.

高新多功能显示屏

采用 10.1 寸高清显示屏, 全新操作界面, 可实现触摸与旋钮多种方式操控。工况、力矩、发动机、变速箱、控制器 IO 点、工作时间统计等丰富的设备状态信息呈现, 集成虚拟墙、蓝牙、收音机等多种扩展功能。

精准力限器系统

三一自主研发的力矩限制器系统, 精度达 0~5%。

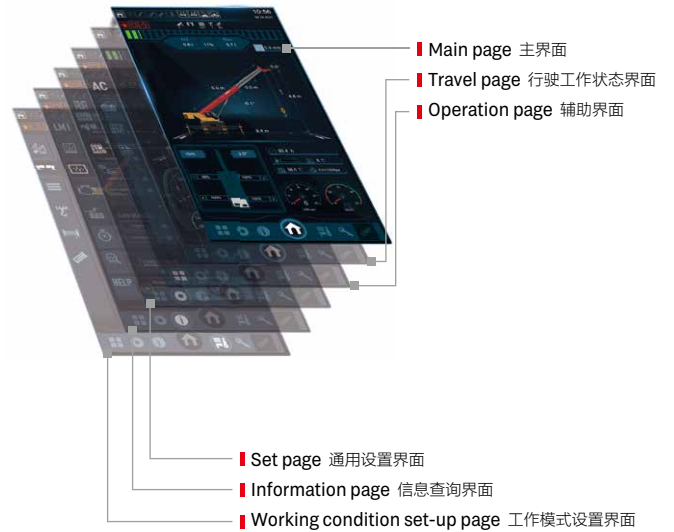

MachineLink⁺

ROOTCLOUD T-AMS Pro device comes as standard to realize GPS trajectory, machine status, maintenance management, E-fence, alarm management, and operator management on computer or mobile MachineLink+ platform, by remote control of cranes. This telematics package greatly boosts efficiency of customer fleet management and helps provide better after-sales services.

标配树根物联终端 T-AMS Pro, 通过对起重机设备的远程控制, 在电脑或移动端 MachineLink+ 平台实现轨迹回放、设备状态、维保设备、电子围栏、报警管理、操作手管理等功能, 极大提高客户设备管理效率, 提升三一售后服务能力。

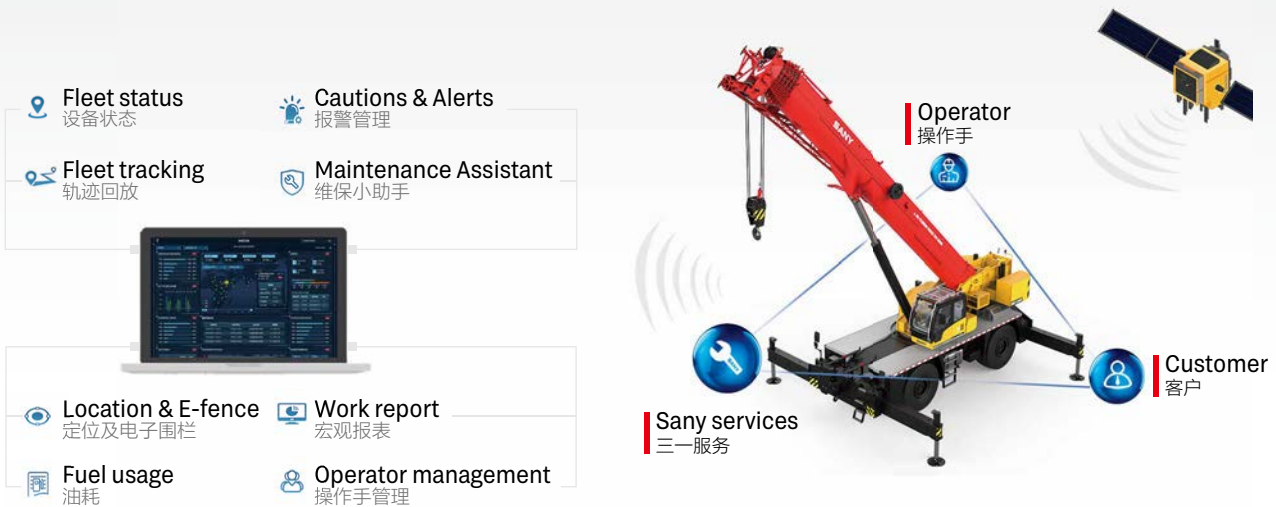

Hydraulic System

液压系统

Six boom sections telescoping via single cylinder pinning mechanism.
Variable length combinations for more applications with higher efficiency.

6节主臂,大臂间彼此独立,采用单缸插销伸缩机构,臂长任意组合。

Superstructure

上车

Electric proportional pump valve dual control system, with small opening valve control for micrometric precision hoisting, and large opening pump control for energy efficiency. Electric proportional passive luffing down system for more reliable and stable performance. Multi-mode slewing to adapt to different user groups and various working conditions.

电比例泵阀双控系统,小开口阀控微动毫米级精准吊装,大开口泵控节能高效;电比例自重落幅系统,更可靠平稳;多模式回转适应不同用户群体、不同工况场景的回转作业。



Chassis

下车

Steering system

A gear pump installed to supply oil for hydraulic steering, steering pressure controlled by electro-proportional relief valve, four steering modes realized by solenoid directional valve.

Suspension system

Different modes including normal driving and Pick & Carry with suspension locked, suspension to be locked when the crane is working.

Outrigger telescoping system

The electro proportional relief valve identifies pressure staging of outrigger telescoping, satisfying operation requirements under high pressure and forming protection under limited pressure.

转向系统

液压转向系统采用凯斯帕齿轮泵提供油源,通过电比例溢流阀精确控制转向压力,通过电磁换向阀实现前轮转向,后轮转向,全轮转向和蟹行转向共计四种转向模式。

悬挂系统

悬挂系统通过选择不同的悬挂模式可以实现正常行驶和锁定模式下的带载行驶;在起重机上车作业时能够对悬挂进行锁定。

支腿伸缩系统

支腿伸缩采用电比例溢流阀对支腿伸缩进行压力分级,既满足高压力动作需求,也可满足限压保护功能。

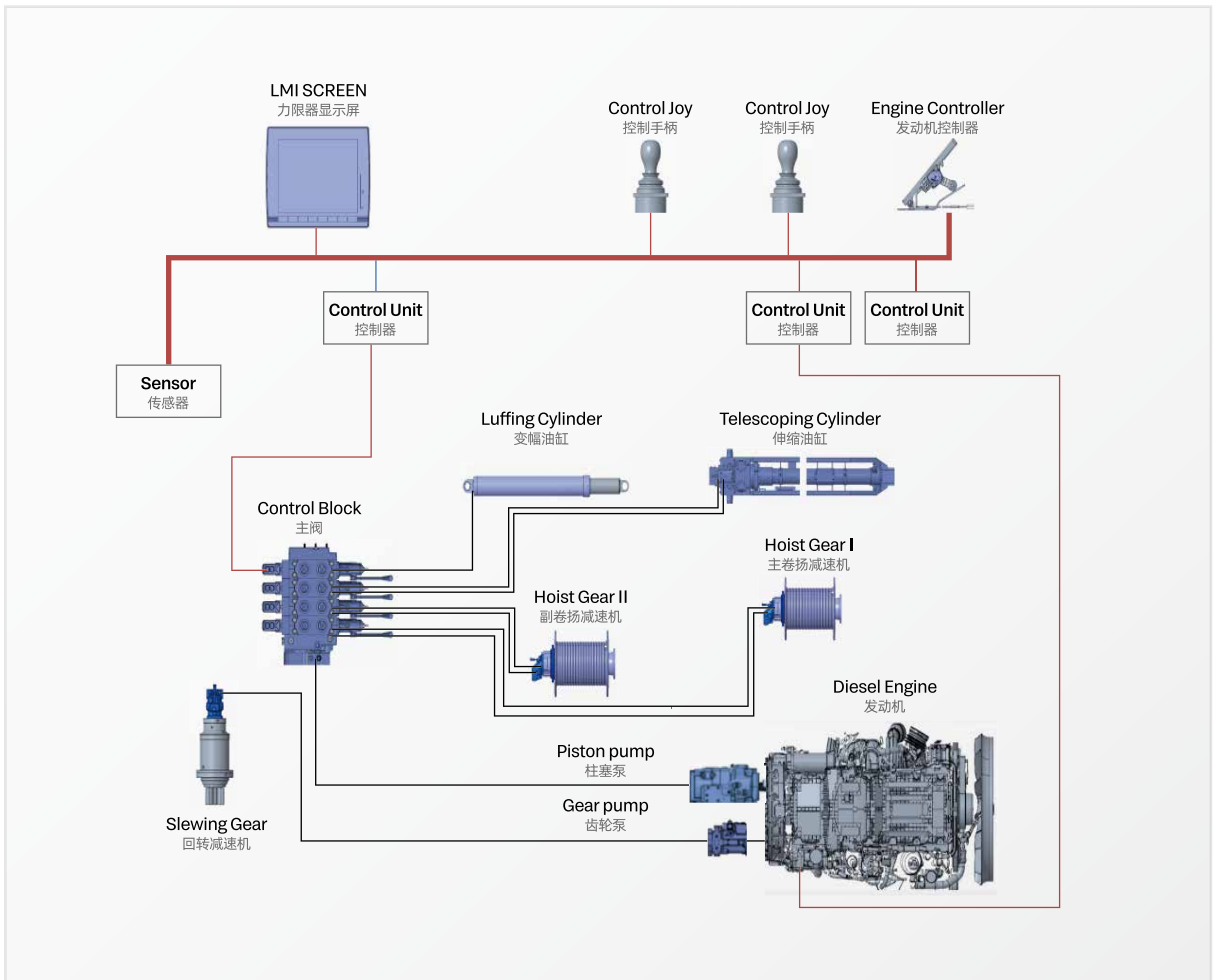

Overall Dimensions

整机尺寸

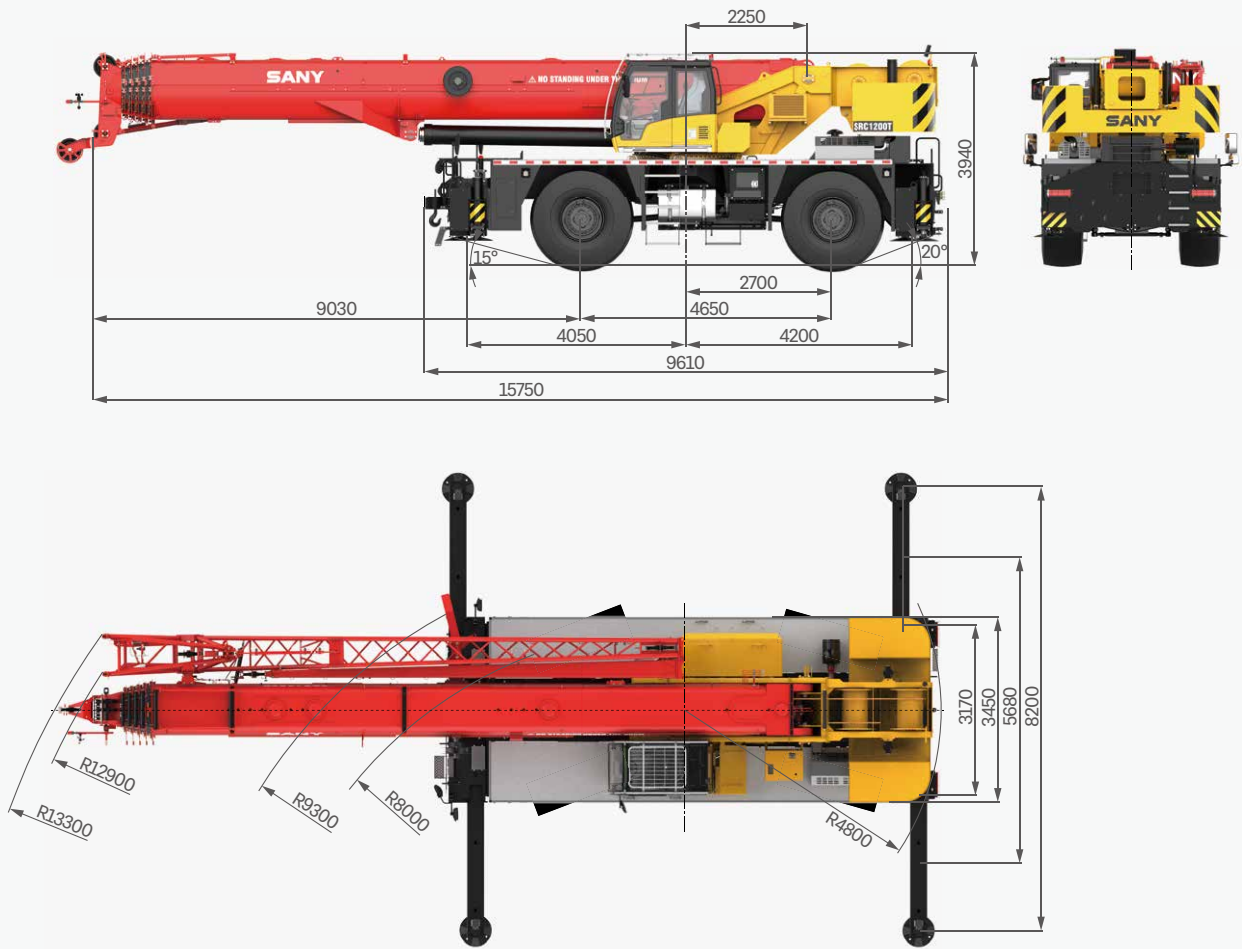

Technical Specification

整机参数

CATEGORY 类型	ITEM 项目	UNIT 单位	VALUE 参数	
CAPACITY 额定起重量	Max. lifting capacity 最大起重量	t	120	
WEIGHT 重量参数	Gross weight 整机总质量	kg	75800	
POWER 发动机参数	Engine model 发动机型号 (排放标准)	-	QSB6.7 (Stage III)	
	Max. engine power 发动机最大功率	kW/rpm	194/2400	
	Max. engine torque 发动机最大输出扭矩	N·m/rpm	990/1500	
DIMENSIONS 尺寸参数	Overall length 整机全长	mm	15750	
	Overall width 整机全宽	mm	3450	
	Overall height 整机全高	mm	3930	
TRAVEL 行驶参数	Max. travel speed 最高行驶速度	km/h	20	
	Steering radius 转弯半径	Min.steering radius 最小转弯半径	m	14.8/8.0
		Min.steering radius of boom tip 臂头最小转弯半径	m	12
	Wheel formula 车轮模式	-	4 × 2 / 4 × 4	
	Min.ground clearance 最小离地间隙	mm	425	
	Approach angle 接近角	°	15	
	Departure angle 离去角	°	20	
	Max.gradeability 最大爬坡度	-	75%	
	Fuel consumption per 100km 每 100 公里油耗	L	125	
MAIN PERFORMANCE 主要性能参数	Working temperature range 使用温度区间	°C	-25~+51	
	Min.rated lifting radius 最小额定幅度	m	2.5	
	Tail slewing radius 转台尾部回转半径	mm	4.8	
	Boom sections (Qty.) 臂节数	-	6	
	Boom shape 臂形状	-	U shape U型	
	Max.lifting moment 最大起重力矩	Basic boom 基本臂	kN·m	3620
		Full-extension boom 全伸主臂	kN·m	1828
		Full-extension boom + jib 全伸主臂 + 副臂	kN·m	612
	Boom length 臂长	Basic boom 基本臂	m	13
		Full-extension boom 全伸主臂	m	60
		Full-extension boom + jib 全伸主臂 + 副臂	m	78.7
	Max.lifting height 最大起重高度	Basic boom 基本臂	m	13.5
		Full-extension boom 全伸主臂	m	60.5
Full-extension boom + jib 全伸主臂 + 副臂		m	80	
Outrigger span (Longitudinal × Transverse) 支腿跨距 (纵 × 横)	m	8.25 × 8.2		
Jib offset 副臂安装角度	°	0, 20, 40		
AIRCONDITIONER 空调	In operator's cab 上车空调	-	Heating & Cooling 制冷、制热	

Technical Specification

整机参数



Axle Load 轴荷

Axle 轴	1	2	Gross weight 总重量
Axle load 轴荷 /kg	39200	36600	75800
Remark 备注	Boom angle 0°, with full water and fuel reservoirs, main hook, one driver, without aux. hook. 起重臂角度 0°、满水、满油、主钩吊臂头、不带副钩, 驾驶员 1 人。		



Hook 吊钩

Rated load 额载 /t	Number of sheaves 滑轮数量	Rope rate 倍率	Hook weight/kg 吊钩重量
120 ○	8	16	1130
90 ●	6	12	830
50 ○	4	8	595
8 ●	-	1	180

● Standard 标配 ○ Optional 选配



Operations 主要动作参数

Item 项目	Max.single rope lifting speed (empty load) 单绳速度 (空载)	Rope diameter/length 钢丝绳直径 / 长度	Max. single line pull 最大单绳拉力
Main winch 主卷扬	150m/min	Φ 20mm/320m	8.3t
Auxiliary winch 副卷扬	150m/min	Φ 20mm/165m	8.3t
Slewing speed 回转速度	1.8r/min		
Full luffing up/down time of boom 主臂起落幅时间	70s/95s		
Full extension/retraction time of boom 主臂伸缩时间	410s/410s		
Outrigger jack 垂直支腿	Retraction 缩	35s	
	Extension 伸	40s	
Outrigger beam 水平支腿	Retraction 缩	30s	
	Extension 伸	30s	

Crane Introduction

整机介绍

Carrier 下车

Carrier frame 车架

- Double longitudinal beam construction welded by high strength steel plate, higher bearing capacity.
- 车架为高强度钢板焊接而成的双纵梁结构，承载能力强。

Engine 发动机

- Model: DF Cummins QSB6.7 C260 inline six-cylinder diesel engine with watercooler and inter cooler.
- Rate power: 194kW/2400rpm.
- Emission standard: Tier III.
- Fuel reservoir capacity: 400L.
- 型号：东风康明斯 QSB6.7 C260 直列六缸、水冷却、增压中冷、柴油发动机。
- 额定功率：194kW/2400rpm。
- 排放标准：符合 III 阶段。
- 油箱容积：400L。

Transmission 变速箱

- Auto-transmission, 6 forward gears and 6 reverse gears, large speed ratio range, adaptable to slope climbing and high-speed traveling.
- 自动变速箱，变速箱有 6 个前进档、6 个后退档，速比范围大，既可满足低速场地爬坡行驶又可满足高速行驶。

Axle 车桥

- Two axle chassis of flexible maneuverability, four-wheel drive, excellent dynamic performance.
- 操控灵活，底盘两桥设计，前、后桥驱动，动力性能好。

Suspension system 悬挂

- The front is rigidly mounted, and the rear axle adopts pivot oscillation suspension with hydraulic lockout.
- 前桥刚性连接，后桥带油缸锁定枢轴摆动悬挂。

Tires 轮胎

- Large diameter off-road 29.5-25 tires deliver large ground clearance and strong off-road agility.
- 大直径越野轮胎，离地间距大，越野性能强，轮胎型号 29.5-25。

Braking 制动系统

- Dual circuit braking system. When one circuit fails, the other can still work normally, improving the safety and reliability of the braking system.
- 双回路制动系统，当某一回路出现故障时，另一回路仍能正常工作，提高制动系统的安全性和可靠性。

Hydraulics 液压系统

- Adopt stable and high-quality main oil pump, enhancing system reliability. Precise parameter matching contributes to superior controllability of the vehicle.
- 采用稳定、高品质的主油泵，系统可靠性高；通过精确的参数匹配，操控性能优越。

Outrigger 支腿

- H-type telescoping outrigger, 4-point support, with span (longitudinal × transverse).
- 采用 H 形伸缩支腿，4 点支撑，纵、横跨距。

Control system 控制系统

- CAN-BUS: The bus instrument of integrated intelligent control electrical system can display driving parameters at any time, making driving easier. At the same time, engine failure prompt]makes the maintenance and troubleshooting more convenient and faster.
- All-round safety protection, the main and auxiliary hoists are equipped with three-circle indicators and A2B switches to prevent over-hoist-down and over winding of the wire ropes.
- Load moment indicator: It adopts highly intelligent moment indicator system to fully protect lifting operation and ensure accuracy, stability and comfort.
- 总线仪表：采用集成一体智能控制电气系统的总线仪表，可随时掌控行驾参数，驾乘轻松；同时拥有发动机故障提示功能，维修排故方便、快捷。
- 全方位的安全保护系统，主、副卷扬配置三圈保护器和高度限位器，防止钢丝绳过放和过卷，防倾翻保护，极限角度保护。
- 力 limiter: 采用高度智能力矩限制器系统，全方位保护吊载作业，确保操作精准、平稳、舒适。

Crane Introduction

整机介绍

superstructure 上车

Operator's cab 操纵室

- New generation T-series operator's cab features curved-rail sliding door, safety glass and corrosion resistant steel construction with softened interior trim. Large internal space with panoramic skylight, adjustable seat and other user-friendly design incl. A/C, electric wiper, making it more comfortable and easier to work. The LMI screen is equipped to realize the logic integration of the control console and the display, so that all working data can be seen at a glance.
- 全新一代 T 系列操纵室，带变轨滑移门，配备安全玻璃，耐腐蚀钢板，配置软化内饰、超大内部空间、可调式座椅等人性化设计，配有空调、电动雨刮器，操作更舒适、轻松；配置力矩限制器显示屏，实现主控台与操作显示系统有机结合，使吊装作业的全部工况数据一目了然。

Boom system 臂架系统

- Boom: Six-section, basic boom 13m, full-extension 60m, made of high-strength welded structural steel with U-shape cross-section.
- Jib: Two-section, 10.3m / 18.7m, offset at 0°, 20°, 40°.
- 主臂：六节臂，基本臂 13m，全伸臂 60m，由高强度焊接结构钢制成，U 形截面。
- 副臂：两节副臂，分别为 10.3m 和 18.7m，安装角度为 0°，20°，40°。

Slewing platform 转台结构

- SANY independently developed, made of fine grain high strength steel in optimized structure.
- 三一自主设计，结构更优化，由细晶粒高强度钢制成。

Hydraulics 液压系统

- Load sensing variable piston pump can adjust displacement in real time to achieve high precision flow control, greatly reducing energy loss.
- Winch adopts electronically controlled variable motor with high operation efficiency. Max. single rope speed of main and auxiliary winch is 150m/min.
- Slewing system integrating slewing buffer and free swing technology, start & brake process is smoother and the inching motion performance is ever better.
- 采用负载敏感变量柱塞泵，能实时调节油泵排量，实现高精度的流量控制，极大的降低能量损耗。
- 卷扬采用电控变量马达，作业效率高；主、副卷扬单绳速度最大达150m/min。
- 回转系统带集成回转缓冲阀，具有自由滑转功能，回转启动和控制平稳，微动性卓越。

Hoist 起升机构

- Pump and motor double variable speed regulation, highly efficient and energy saving. Balance valve and unique anti-hook-slip technology are perfectly coupled to achieve smooth rise and fall of the load. Non-rotation high strength wire rope is used.
- 泵、马达双变量调速，高效节能。卷扬平衡阀与独特的防溜钩技术完美结合，重物起落平稳。配备防旋转高强度钢丝绳。

Luffing system 变幅系统

- Double acting single rod hydraulic cylinder with balance valve, luffing angle: -2°~80°. Passive luffing down, reducing energy consumption, improving luffing stability.
- 双作用单活塞杆液压缸，带安全平衡阀，变幅角度：-2°~80°，采用自重落幅系统，降低能耗，提高落幅操作的平稳性。

Slewing 回转系统

- 360° slewing in both directions, max. speed 1.8r/min. Three slewing modes: anti-slip mode, semi-drift mode, and drift mode, to meet the needs of different user groups and various working conditions.
- 360° 转动，最大回转速度 1.8r/min。3 种回转模式：防溜模式、半漂移模式、飘移模式，满足不同用户群体、不同工况场景的使用需求。

Counterweight 配重

- Fixed counterweight + hydraulic cylinder lifting counterweight totaling 23t.
- 固定配重 + 油缸提升配重共 23t。

Safety equipment 安全装置

- Load moment indicator: Analytical mechanics is applied and moment limiter calculation system based on the hoisting mechanics model is established. Through online empty-load calibration, the rated accuracy can reach 0-10% to fully protect the hoisting operation. In case of overload, the system will automatically give an alarm to guarantee safety operation.
- The hydraulic system includes balance valve, relief valve, two-way holding valve, etc. to realize system stability and reliability.
- The main and auxiliary winches are equipped with third-wrap indicators to prevent over-hoist-down of the wire rope.
- Boom head and jib head are equipped with A2B switches to prevent the wire rope from over winding.
- The length & angle sensor and pressure sensor are equipped to signify working status in real time, automatically stopping hazardous actions with buzzer alarm.
- 力矩限制器：采用分析力学方法，建立了基于吊重力学模型的力矩限制器计算系统，通过在线空载标定，额定吊重精度达到 0-10%，全方位保护吊载作业；超载作业时，系统自动报警提示，为操纵作业提供安全保障。
- 液压系统配置平衡阀、溢流阀、双向液压锁等元件，实现液压系统稳定可靠。
- 主、副卷扬配置三圈保护器，防止钢丝绳过放。
- 主、副臂臂端配置高度限位器，防止钢丝绳过卷。
- 配置长度角度传感器、压力传感器，实时显示起重机作业状态，自动切断危险动作，蜂鸣报警。

Optional equipment at extra fees 选配

- Winch camera / Boom tip camera / Reversing camera / 120t hook block / 50t hook block / Spark arrester / Air intake shutoff valve / Outrigger pads / other equipment available upon request.
- 卷扬监控 / 臂尖摄像头 / 倒车监控 / 120t 吊钩 / 50t 吊钩 / 火星灭火器 / 发动机进气关断阀 / 支腿垫板 // 其他选配视需求定。

Working Conditions

工况组合

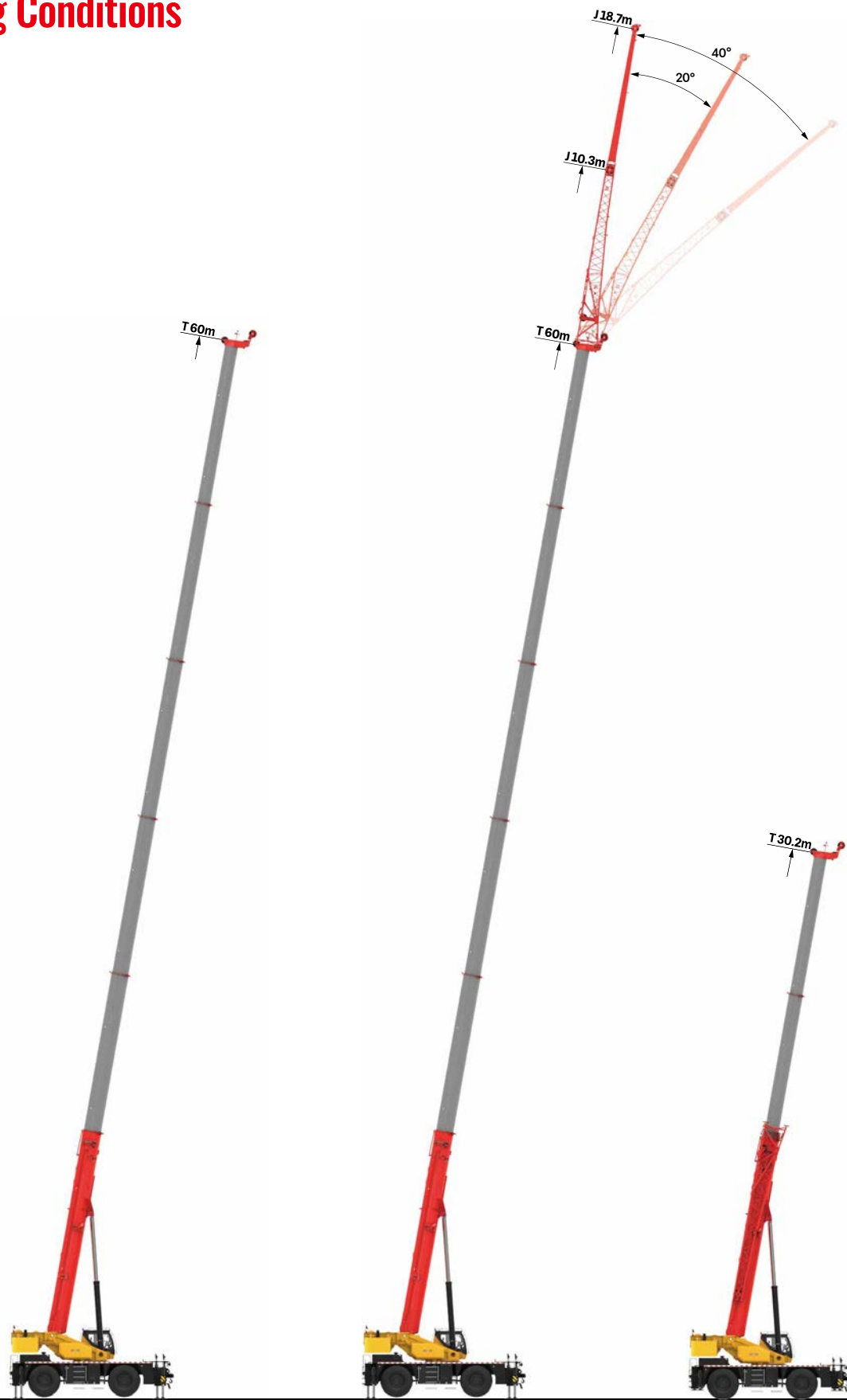

Telescopic boom on outriggers
主臂、支腿吊载

Fixed jib on outriggers
固定副臂、支腿吊载

Telescopic boom on tires
主臂、轮胎吊载

Operating Range - Telescopic Boom

起升高度曲线 - 主臂

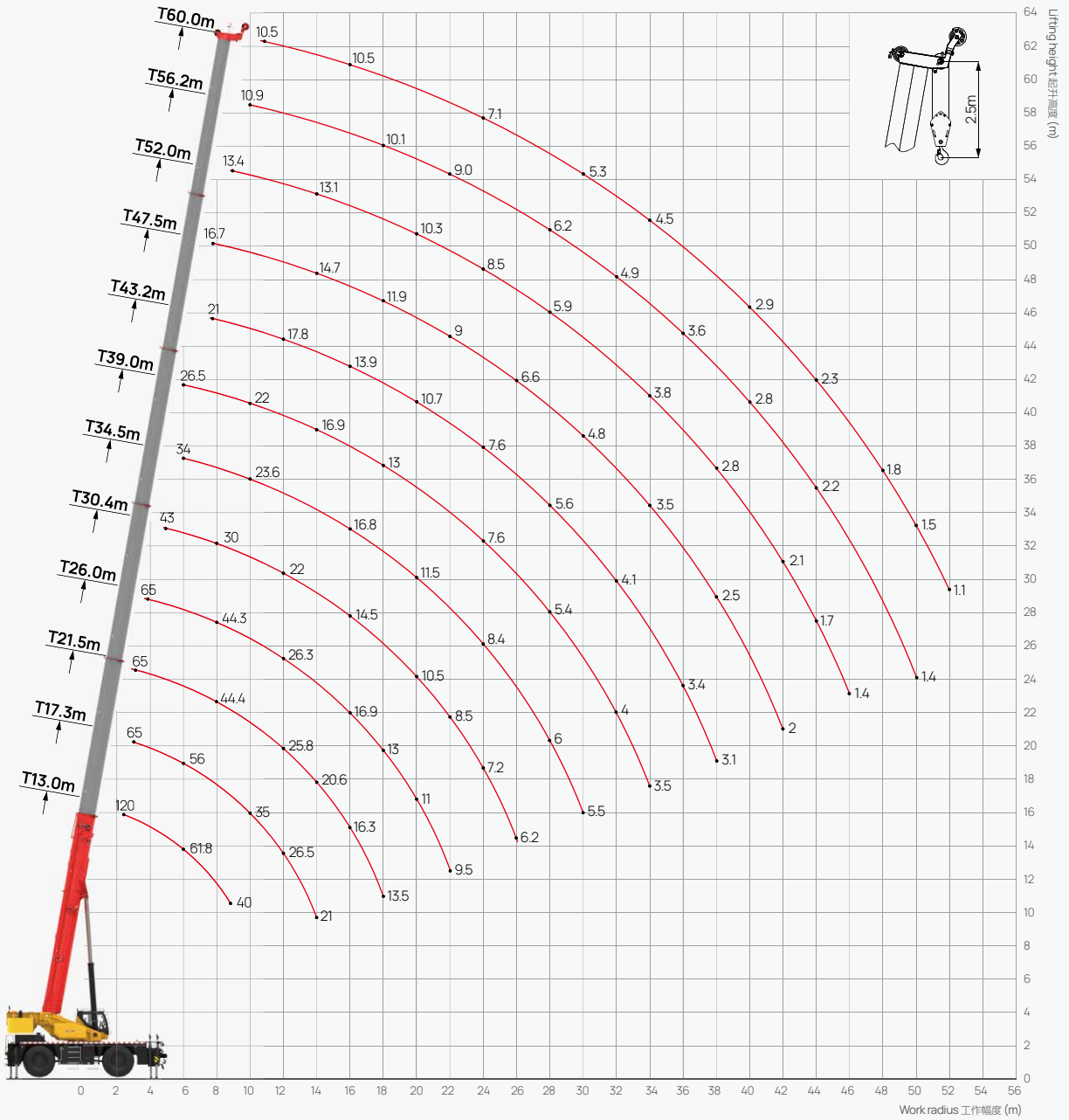





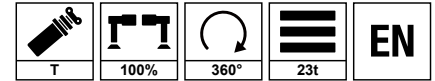

Load Chart-Telescopic Boom

性能表 - 主臂

Unit: t









	13.0	17.3	17.3	17.3	21.5	21.6	21.7	21.7	25.9	25.9	26.0	26.0	
2.5	120.0	36.0	65.0	65.0	35.0	35.0	65.0	65.0					2.5
3.0	110.0	36.0	65.0	65.0	35.0	35.0	65.0	65.0	32.0	35.0	65.0	35.0	3.0
3.5	96.0	36.0	65.0	65.0	33.2	35.0	65.0	65.0	30.5	35.0	65.0	35.0	3.5
4.0	87.0	36.0	65.0	65.0	31.4	35.0	65.0	65.0	30.0	35.0	65.0	35.0	4.0
4.5	79.5	36.0	65.0	65.0	29.7	35.0	65.0	65.0	27.5	35.0	64.0	35.0	4.5
5.0	73.0	36.0	65.0	63.2	28.0	35.0	65.0	63.0	26.0	35.0	60.0	35.0	5.0
5.5	66.7	36.0	65.0	60.0	27.0	35.0	64.1	59.8	25.0	35.0	57.0	35.0	5.5
6.0	61.8	36.0	61.0	57.0	25.8	35.0	61.0	56.8	24.0	35.0	54.0	35.0	6.0
6.5	56.2	36.0	56.0	54.5	24.5	34.5	56.1	54.0	23.0	35.0	51.5	35.0	6.5
7.0	52.0	35.5	51.5	51.6	23.5	33.0	51.3	50.5	22.0	34.0	49.0	35.0	7.0
7.5	48.3	34.3	48.0	47.6	22.5	32.0	47.7	47.5	21.1	32.5	47.0	35.0	7.5
8.0	45.2	33.3	45.0	44.8	22.0	30.8	44.5	44.4	20.4	32.2	44.3	35.0	8.0
9.0	40.0	30.5	39.5	39.0	20.0	28.5	39.0	38.9	18.9	28.8	38.5	35.0	9.0
10.0		27.1	34.6	35.0	18.5	26.7	34.5	35.0	17.6	26.7	34.5	34.0	10.0
11.0		25.0	30.5	31.2	17.0	25.0	31.0	31.5	16.5	25.0	30.8	30.3	11.0
12.0		23.1	26.0	26.5	15.8	23.5	25.5	25.8	15.5	23.5	26.3	26.3	12.0
14.0		19.5	20.5	21.0	13.6	21.2	20.5	20.6	13.8	21.0	20.0	20.1	14.0
16.0					12.3	17.5	16.0	16.3	12.5	17.5	16.9	16.0	16.0
18.0					11.0	15.2	13.0	13.5	11.4	14.5	13.0	13.2	18.0
20.0									10.5	12.5	11.0	10.8	20.0
22.0									9.2	10.5	9.5	10.0	22.0
24.0													24.0
26.0													26.0
28.0													28.0
30.0													30.0
32.0													32.0
34.0													34.0
36.0													36.0
38.0													38.0
40.0													40.0
42.0													42.0
44.0													44.0
46.0													46.0
48.0													48.0
50.0													50.0
52.0													52.0
 2#	0	0	0	0	0	0	46	0	0	0	46	0	2#
3#	0	0	46	0	0	0	46	46	0	0	46	46	3#
 4#	0	0	0	46	0	0	0	46	0	46	46	46	4# 
5#	0	0	0	0	0	46	0	0	46	46	0	46	5#
6#	0	46	0	0	92	46	0	0	92	46	0	0	6#
	16	6	10	10	6	6	10	10	6	6	10	6	

Load Chart-Telescopic Boom

性能表 - 主臂

Unit: t







	30.2	30.3	30.4	30.3	34.5	34.6	34.7	34.5	38.9	39.0	38.9	
2.5												2.5
3.0												3.0
3.5												3.5
4.0	25.0	35.0	47.0	35.0								4.0
4.5	23.0	35.0	43.0	35.0	22.8	32.0	35.0	27.5				4.5
5.0	22.0	35.0	41.0	35.0	22.0	32.0	35.0	26.5				5.0
5.5	21.0	35.0	38.5	35.0	21.3	32.0	35.0	25.6	19.8	26.5	23.5	5.5
6.0	20.0	35.0	36.5	35.0	20.5	32.0	34.0	24.5	19.7	26.5	23.5	6.0
6.5	19.5	35.0	34.5	35.0	20.0	32.0	32.0	24.0	19.1	26.5	23.5	6.5
7.0	18.5	35.0	33.0	35.0	19.0	32.0	30.5	23.6	18.5	26.5	23.0	7.0
7.5	17.8	34.5	31.5	35.0	18.3	32.0	29.0	22.5	17.9	26.5	22.3	7.5
8.0	17.0	33.4	30.0	35.0	17.8	32.0	27.6	22.0	17.3	25.7	21.7	8.0
9.0	15.7	31.0	27.6	35.0	16.7	32.0	26.0	20.6	16.4	24.0	20.9	9.0
10.0	14.6	28.9	25.5	33.0	15.6	31.0	23.6	19.5	15.2	22.0	19.7	10.0
11.0	13.6	27.1	23.5	32.5	14.8	28.6	22.0	18.5	14.0	20.5	18.7	11.0
12.0	12.9	25.5	22.0	25.5	13.8	26.5	20.5	17.5	13.2	19.5	18.0	12.0
14.0	11.4	22.8	18.7	19.5	12.4	21.0	18.0	16.0	11.5	16.9	16.4	14.0
16.0	10.2	19.0	14.5	15.4	11.2	16.8	15.5	14.7	10.2	15.0	15.1	16.0
18.0	9.2	15.2	11.8	12.5	10.1	13.8	13.0	13.7	9.2	13.0	13.9	18.0
20.0	8.4	12.8	10.5	10.2	9.3	11.5	11.0	12.1	8.3	10.7	12.0	20.0
22.0	7.8	10.8	8.5	8.5	8.5	10.0	9.5	10.5	7.6	9.0	10.0	22.0
24.0	7.6	9.2	7.2	8.5	7.9	8.4	7.5	9.0	7.0	7.6	8.8	24.0
26.0	6.0	8.0	6.2	7.0	7.4	7.0	6.5	7.9	6.5	6.4	7.5	26.0
28.0					6.8	6.0	5.5	7.2	6.0	5.4	6.5	28.0
30.0					6.0	5.5	4.4	6.5	5.6	4.6	5.8	30.0
32.0									5.6	4.0	5.0	32.0
34.0									4.8	3.5	4.5	34.0
36.0												36.0
38.0												38.0
40.0												40.0
42.0												42.0
44.0												44.0
46.0												46.0
48.0												48.0
50.0												50.0
52.0												52.0
 2#	0	0	92	46	0	46	92	0	0	92	46	2#
3#	0	46	46	46	0	46	46	46	0	46	46	3#
 4#	0	46	46	46	46	46	46	46	92	46	46	4# 
5#	92	46	0	46	92	46	46	46	92	46	46	5#
6#	92	46	0	0	92	46	0	92	92	46	92	6#
	4	6	8	6	4	4	6	6	4	4	4	

Load Chart-Telescopic Boom

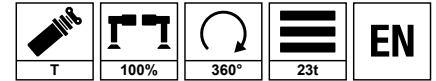
性能表 - 主臂

Unit: t







	43.2	43.2	43.3	43.2	47.5	47.6	47.6	51.9	52.0	56.2	60.0	
2.5												2.5
3.0												3.0
3.5												3.5
4.0												4.0
4.5												4.5
5.0												5.0
5.5												5.5
6.0												6.0
6.5	16.5	17.8	21.0	20.0								6.5
7.0	16.5	17.8	21.0	20.0								7.0
7.5	16.5	17.8	21.0	20.0	14.0	16.7	15.5					7.5
8.0	16.5	17.5	21.0	20.0	14.0	16.7	15.5					8.0
9.0	16.3	16.6	21.0	20.0	14.0	16.7	15.5	12.3	13.4			9.0
10.0	15.5	15.8	20.1	19.5	14.0	16.7	15.5	12.3	13.4	10.9		10.0
11.0	14.7	15.0	19.1	18.6	14.0	16.7	15.4	12.3	13.4	10.9	10.5	11.0
12.0	13.8	14.5	17.8	18.0	13.3	16.2	14.7	12.3	13.4	10.9	10.5	12.0
14.0	12.3	13.3	15.6	16.1	12.2	14.7	13.4	12.0	13.1	10.9	10.5	14.0
16.0	11.0	12.2	13.9	14.3	11.1	13.2	12.2	11.0	12.1	10.8	10.5	16.0
18.0	10.0	11.2	12.6	12.8	10.1	11.9	11.2	10.2	11.2	10.1	10.2	18.0
20.0	9.1	10.3	10.7	11.5	9.3	10.8	10.3	9.5	10.3	9.5	9.0	20.0
22.0	8.3	9.8	9.0	9.7	8.6	9.0	9.6	8.9	9.1	9.0	7.7	22.0
24.0	7.8	9.2	7.6	8.1	7.9	7.6	8.7	8.4	8.5	8.4	7.1	24.0
26.0	7.3	7.9	6.5	7.0	7.4	6.6	7.2	8.0	6.9	7.2	6.5	26.0
28.0	6.8	6.7	5.6	6.0	6.9	5.6	6.2	6.8	5.9	6.2	5.8	28.0
30.0	6.3	5.9	4.8	5.2	6.0	4.8	5.4	6.0	5.2	5.5	5.3	30.0
32.0	6.0	5.2	4.1	4.5	5.4	4.1	4.6	5.2	4.5	4.9	4.9	32.0
34.0	5.5	4.6	3.7	3.9	4.8	3.5	4.0	4.7	3.8	4.2	4.5	34.0
36.0	5.0	4.1	3.4	3.5	4.2	2.8	3.5	5.3	3.3	3.6	4.0	36.0
38.0	4.3	3.8	3.1	3.2	3.8	2.5	3.0	3.8	2.8	3.2	3.6	38.0
40.0					3.3	2.1	2.8	3.4	2.4	2.8	2.9	40.0
42.0					2.7	2.0	2.6	3.0	2.1	2.4	2.5	42.0
44.0								2.6	1.7	2.2	2.3	44.0
46.0								2.1	1.4	2.0	2.1	46.0
48.0										1.7	1.8	48.0
50.0										1.4	1.5	50.0
52.0											1.1	52.0
2#	0	46	92	92	0	92	46	46	92	92	100	2#
3#	46	46	92	46	92	92	92	92	92	92	100	3#
4#	92	46	46	46	92	92	92	92	92	92	100	4#
5#	92	92	46	46	92	46	92	92	92	92	100	5#
6#	92	92	46	92	92	46	46	92	46	92	100	6#
	4	4	4	4	4	4	4	4	4	4	4	

Load Chart-Telescopic Boom

性能表 - 主臂

Unit: t









	13.0	17.3	21.6	25.9	30.3	34.6	39.0	43.3	47.5	51.9	56.2	60.0	
2.5	90.0												2.5
3.0	85.0	35.0	35.0										3.0
3.5	72.0	35.0	35.0	35.0									3.5
4.0	70.0	35.0	35.0	35.0	35.0								4.0
4.5	68.8	35.0	35.0	35.0	35.0	33.1							4.5
5.0	59.0	35.0	35.0	35.0	35.0	33.1							5.0
5.5	55.6	35.0	34.0	35.0	35.0	33.1							5.5
6.0	51.5	35.0	32.0	35.0	35.0	33.1	26.4						6.0
6.5	44.5	35.0	29.5	34.0	35.0	33.1	26.4						6.5
7.0	41.0	34.0	27.5	33.0	35.0	33.1	26.4	21.0					7.0
7.5	36.0	33.0	26.0	32.0	33.5	32.0	25.5	21.0	14.0				7.5
8.0	30.0	31.0	24.5	30.1	31.5	30.5	24.3	20.5	14.0				8.0
9.0	25.7	27.5	22.1	28.3	28.7	28.0	23.5	20.0	14.0	12.3			9.0
10.0		22.5	20.1	23.8	25.0	24.0	21.0	19.0	14.0	12.3	10.9		10.0
11.0		19.0	18.5	21.0	21.5	20.8	19.1	18.3	14.0	12.3	10.9	10.2	11.0
12.0		16.8	17.3	18.0	18.0	17.4	17.5	17.5	13.2	12.3	10.9	10.2	12.0
14.0			14.2	14.7	14.5	12.0	13.9	13.8	11.8	11.8	10.9	10.2	14.0
16.0			10.5	11.0	11.5	10.0	11.5	11.3	10.4	10.2	9.5	9.5	16.0
18.0				8.9	9.0	8.9	8.5	9.5	9.4	9.0	8.8	8.6	18.0
20.0				7.4	7.8	7.2	6.9	7.0	8.2	7.9	7.6	7.5	20.0
22.0				6.0	6.2	6.3	5.5	5.8	7.4	6.5	6.2	6.1	22.0
24.0					5.0	5.4	4.3	4.3	6.0	5.3	5.0	4.9	24.0
26.0					3.0	3.9	3.6	3.8	5.0	4.6	4.3	4.3	26.0
28.0						3.2	2.7	2.9	4.6	3.5	3.2	3.2	28.0
30.0						2.8	2.1	2.2	4.2	2.9	2.7	2.7	30.0
32.0							1.7	1.7	3.0	2.3	2.4	2.4	32.0
34.0							1.3	1.4	2.6	2.0	1.7	1.7	34.0
36.0									2.2	1.7	1.4	1.4	36.0
38.0									1.7	1.3			38.0
40.0									1.4				40.0
42.0													42.0
2#	0	0	0	0	0	46	92	92	0	46	92	100	2#
3#	0	0	0	0	46	46	46	92	92	92	92	100	3#
4#	0	0	0	46	46	46	46	46	92	92	92	100	4#
5#	0	0	46	46	46	46	46	46	92	92	92	100	5#
6#	0	46	46	46	46	46	46	46	92	92	92	100	6#
	12	6	6	6	6	4	4	4	4	4	4	4	

Load Chart-Telescopic Boom

性能表 - 主臂

Unit: t



 m	13.0	17.3	21.6	25.9	30.3	34.6	39.0	43.3	47.5	51.9	56.2	60.0	 m
6.0	24.0												6.0
6.5	21.5												6.5
7.0	18.5												7.0
7.5	16.6	18.3											7.5
8.0	14.2	15.5	17.3										8.0
9.0	11.9	13.5	14.4	14.5	14.5								9.0
10.0		11.0	12.3	12.8	11.2	11.0	10.5						10.0
11.0		9.2	11.0	11.3	8.9	9.5	9.5	10.2	9.5	9.0			11.0
12.0		7.9	8.8	9.0	7.2	8.3	8.5	9.4	9.5	9.0	8.5	8.0	12.0
14.0			7.0	7.3	5.9	7.2	7.5	7.4	7.5	7.4	7.2	7.0	14.0
16.0			5.0	5.2	4.9	5.5	5.6	5.5	6.0	5.9	6.0	5.8	16.0
18.0			4.0	3.9	3.8	4.1	4.2	4.1	4.5	4.4	4.5	4.4	18.0
20.0				3.2	2.1	3.2	3.3	3.2	3.9	3.7	3.8	3.7	20.0
22.0				2.3	1.8	2.6	2.7	2.6	3.4	3.3	3.3	3.3	22.0
24.0					1.5	2.0	2.1	2.0	3.0	2.8	2.6	2.6	24.0
26.0						1.5	1.5	1.5	2.4	2.2	2.1	2.1	26.0
28.0									2.0	1.7	1.7	1.7	28.0
30.0									1.4	1.3	1.3	1.3	30.0
 2#	0	0	0	0	0	46	92	92	0	46	92	100	2#
3#	0	0	0	0	46	46	46	92	92	92	92	100	3#
 4#	0	0	0	46	46	46	46	46	92	92	92	100	4# 
5#	0	0	46	46	46	46	46	46	92	92	92	100	5#
6#	0	46	46	46	46	46	46	46	92	92	92	100	6#
 2 _n	4	4	4	4	4	4	4	4	4	4	4	4	2 _n 

Remark

- Load capacity in the chart is the maximum weight which this crane could hoist include the hook blocks' weight. The main hook weighs 830kg, the aux. hook weighs 160kg.
- Radius shown in the chart is the actual radius when loading.
- The load capacity in the chart is the maximum weight when this crane is supported with the firm ground and stays in level.
- Choose rated load capacity of the longer boom and radius when the actual boom length and radius are between two values in the charts.
- The machine can be used only when the wind power is less than grade 6.

- 性能表中额定起重量包括起重钩 (主钩重 830kg, 副钩重 160kg) 和吊具的重量。
- 性能表中工作幅度是指吊载后的实际幅度。
- 性能表中给定数值是在平整坚固的地面上, 整机调平状态下起重机的最大起重量。
- 如实际臂长和幅度介于两个数值之间时, 取较长的臂长及较大的幅度所决定的额定起重量进行起重作业。
- 起重作业风力等级需低于 6 级。

Operating Range - Fixed Jib

起升高度曲线 - 副臂

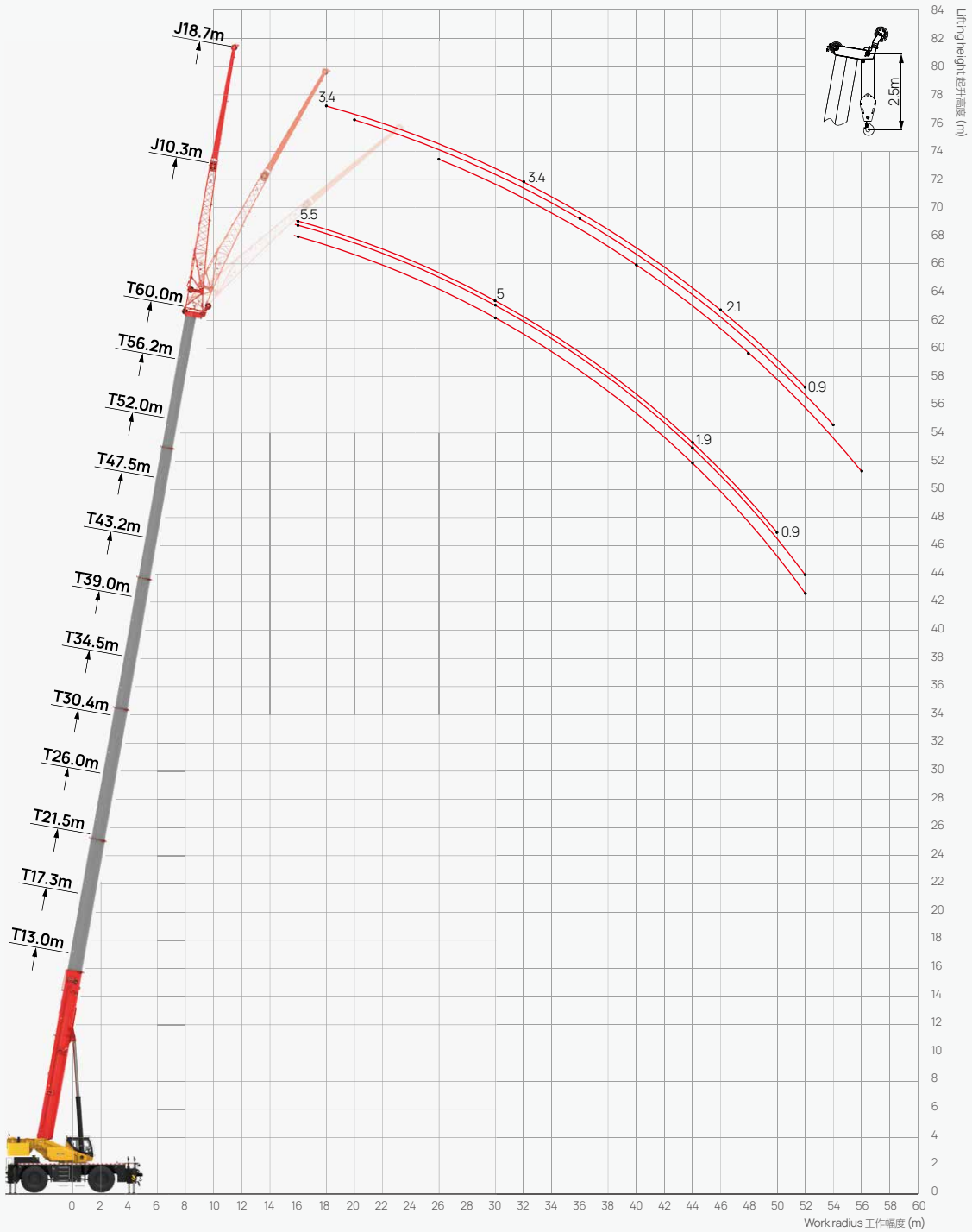

Load Chart - Fixed Jib

性能表 - 副臂

Unit: t

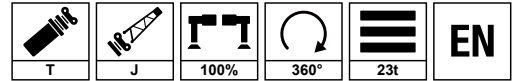





	60m+10.3m			60m+18.7m			
	0°	20°	40°	0°	20°	40°	
14	5.5						14
16	5.5	5.5		3.4			16
18	5.5	5.5	5.5	3.4			18
20	5.5	5.5	5.5	3.4	3.4		20
22	5.5	5.5	5.5	3.4	3.4		22
24	5.5	5.5	5.5	3.4	3.4		24
26	5.5	5.5	5.5	3.4	3.4	3.1	26
28	5.5	5.5	5.5	3.4	3.4	3.1	28
30	5.0	5.0	5.0	3.4	3.4	3.0	30
32	4.6	4.5	4.5	3.4	3.4	2.9	32
34	4.2	4.1	4.2	3.4	3.3	2.9	34
36	3.9	3.9	3.9	3.4	3.3	2.8	36
38	3.3	3.6	3.7	3.2	3.2	2.7	38
40	2.8	3.1	3.2	3.0	3.0	2.7	40
42	2.3	2.6	2.8	2.7	2.8	2.6	42
44	1.9	2.2	2.3	2.4	2.5	2.5	44
46	1.5	1.8	1.9	2.1	2.3	2.3	46
48	1.2	1.4	1.5	1.8	2.1	2.0	48
50	0.9	1.1	1.2	1.5	1.8	1.8	50
52		0.8	0.9	1.2	1.6	1.7	52
54				1.0	1.3	1.5	54
56					1.1	1.2	56
58					0.8	0.9	58

Load Chart - Telescopic Boom, Pick & Carry, Load Over Front

性能表 - 主臂帶載行駛 (正前方)

Unit: t







	13	17.3	21.5	25.8	30.2		
2.5	18.0					2.5	
3.0	18.0	18.0				3.0	
3.5	16.0	16.5	17.0			3.5	
4.0	14.5	15.0	15.5	15.0		4.0	
4.5	13.0	13.5	14.0	15.0	15.0	4.5	
5.0	12.4	12.8	13.1	13.5	14.0	5.0	
5.5	11.2	11.5	11.8	12.0	12.5	5.5	
6.0	10.0	10.5	11.0	11.0	12.0	6.0	
6.5	9.0	9.8	10.3	10.5	10.6	6.5	
7.0	8.5	8.6	9.0	10.0	10.0	7.0	
7.5	7.5	8.0	8.5	9.5	9.6	7.5	
8.0	7.0	7.3	7.8	8.5	8.8	8.0	
9.0	6.0	6.5	7.0	7.6	7.8	9.0	
10.0		5.5	6.0	6.5	7.0	10.0	
11.0		4.5	5.0	5.6	5.8	11.0	
12.0		4.0	4.5	5.3	5.5	12.0	
14.0		3.2	4.2	4.4	4.5	14.0	
16.0			3.8	3.6	3.7	16.0	
18.0			2.2	2.8	3.0	18.0	
20.0				2.5	2.5	20.0	
22.0				2.0	2.0	22.0	
24.0					1.8	24.0	
26.0					1.3	26.0	
	2#	0	0	0	0	2#	
	3#	0	0	0	0	3#	
	4#	0	0	0	0	4#	
	5#	0	0	0	46	92	5#
	6#	0	46	92	92	92	6#
	4	4	4	4	4		

Load Chart - Telescopic Boom, On Tires Stationary, Load Over Front

性能表 - 轮胎静止吊载 (正前方)

Unit: kg







 m	13	17.3	21.5	25.8	30.2	 m	
2.5	30.0					2.5	
3.0	30.0	30.0				3.0	
3.5	27.0	26.0	28.0			3.5	
4.0	24.0	24.5	24.8	26.0		4.0	
4.5	23.0	22.5	24.0	25.0	22.0	4.5	
5.0	21.0	21.0	21.5	22.0	21.0	5.0	
5.5	19.6	19.8	20.0	20.3	20.3	5.5	
6.0	18.0	18.5	19.0	19.5	19.0	6.0	
6.5	16.4	16.8	17.2	17.5	17.5	6.5	
7.0	15.3	15.5	15.8	16.0	16.8	7.0	
7.5	14.0	15.0	15.5	16.0	16.5	7.5	
8.0	12.3	13.0	13.5	14.0	14.5	8.0	
9.0	11.5	12.5	13.2	13.5	13.5	9.0	
10.0		11.5	11.7	12.0	12.2	10.0	
11.0		10.0	10.5	11.5	11.5	11.0	
12.0		8.5	9.1	9.8	10.0	12.0	
14.0		6.2	7.0	7.7	8.1	14.0	
16.0			5.5	6.2	6.5	16.0	
18.0			4.2	5.0	5.2	18.0	
20.0				4.0	4.2	20.0	
22.0				3.0	3.5	22.0	
24.0					2.8	24.0	
26.0					1.5	26.0	
	2#	0	0	0	0	2#	
	3#	0	0	0	0	3#	
	4#	0	0	0	0	4#	
	5#	0	0	0	46	92	5#
	6#	0	46	92	92	92	6#
	4	4	4	4	4		

Load Chart - Telescopic Boom, On Tires Stationary, 360° Slewing

性能表 - 轮胎静止吊载 (360°)

Unit: kg



 m	13	17.3	21.5	25.8	30.2	 m
7.5	10.0					7.5
8.0	8.6					8.0
9.0	7.3					9.0
10.0		7.2				10.0
11.0		6.2	7.0			11.0
12.0		4.9	5.6			12.0
14.0			4.2	4.5	4.7	14.0
16.0			2.5	3.5	3.5	16.0
18.0			1.5	2.6	2.7	18.0
20.0				1.5	2.2	20.0
22.0					1.5	22.0
	2#	0	0	0	0	2#
	3#	0	0	0	0	3#
	4#	0	0	0	0	4#
	5#	0	0	0	46	5#
	6#	0	46	92	92	92
	4	4	4	4	4	

Remark

1. Capacities are applicable at 725kPa cold tire inflation pressure.
 2. Capacities are applicable only with machine on firm level surface.
 3. On tire lifting with the jib mounted is not permitted.
 4. Axle lockouts must be applied when lifting on tires.
 5. Parking brake must be applied when lifting on tires stationary.
 6. Driving speed shall be ≤4km/h at pick & carry mode.
1. 冷态轮胎气压需保持 725kPa。
 2. 起重机需在平整坚固的地面上作业。
 3. 轮胎吊载工况不允许使用副臂吊载。
 4. 轮胎吊载工况中，车桥悬挂需锁定。
 5. 轮胎静止吊载工况中，需使用驻车制动。
 6. 带载行驶工况中，直线行驶速度需小于等于 4km/h。



SANY GROUP CRANE BU

SANY Mobile Crane Industrial Park, No.168 Jinzhou Avenue, Jinzhou Development Zone, Changsha City,
Hunan Province, P.R. China Zip 410600
Consulting sanycrane@sanygroup.com (Crane BU) / crd@sany.com.cn (IHQ)
After-sales Service 0086-400 6098 318

Reminder:

Any change in the technical parameters and configuration due to product modification or upgrade may occur without prior notice.
The machine in the picture may include additional equipment. This brochure is for reference only, and goods in kind shall prevail.
Copyright at SANY. No part of this brochure may be copied or used for any purpose without written approval from SANY.

© Edited in May 2024

三一集团起重事业部

中国湖南长沙金洲开发区金洲大道 168 号 三一汽车起重机产业园 邮编: 410600
咨询: sanycrane@sanygroup.com (起重事业部) / crd@sany.com.cn (国际总部)
海外售后服务: 0086-400 6098 318

温馨提示:

由于技术不断更新, 技术参数及配置如有更改, 恕不另行通知。图中机器可能包括附加设备, 本画册仅供参考, 以实物为准。
版权为三一所有, 未经三一书面许可, 本画册任何内容不得被复制用于任何目的。

© 2024 年 5 月版

