



SLT125H(T5022-8)

SANY Tower Crane
三一重工塔式起重机



**Better World
Better SANY Crane**

SANY CRANE



Luffing Jib Length & Tip Load 动臂臂长组合及吊重

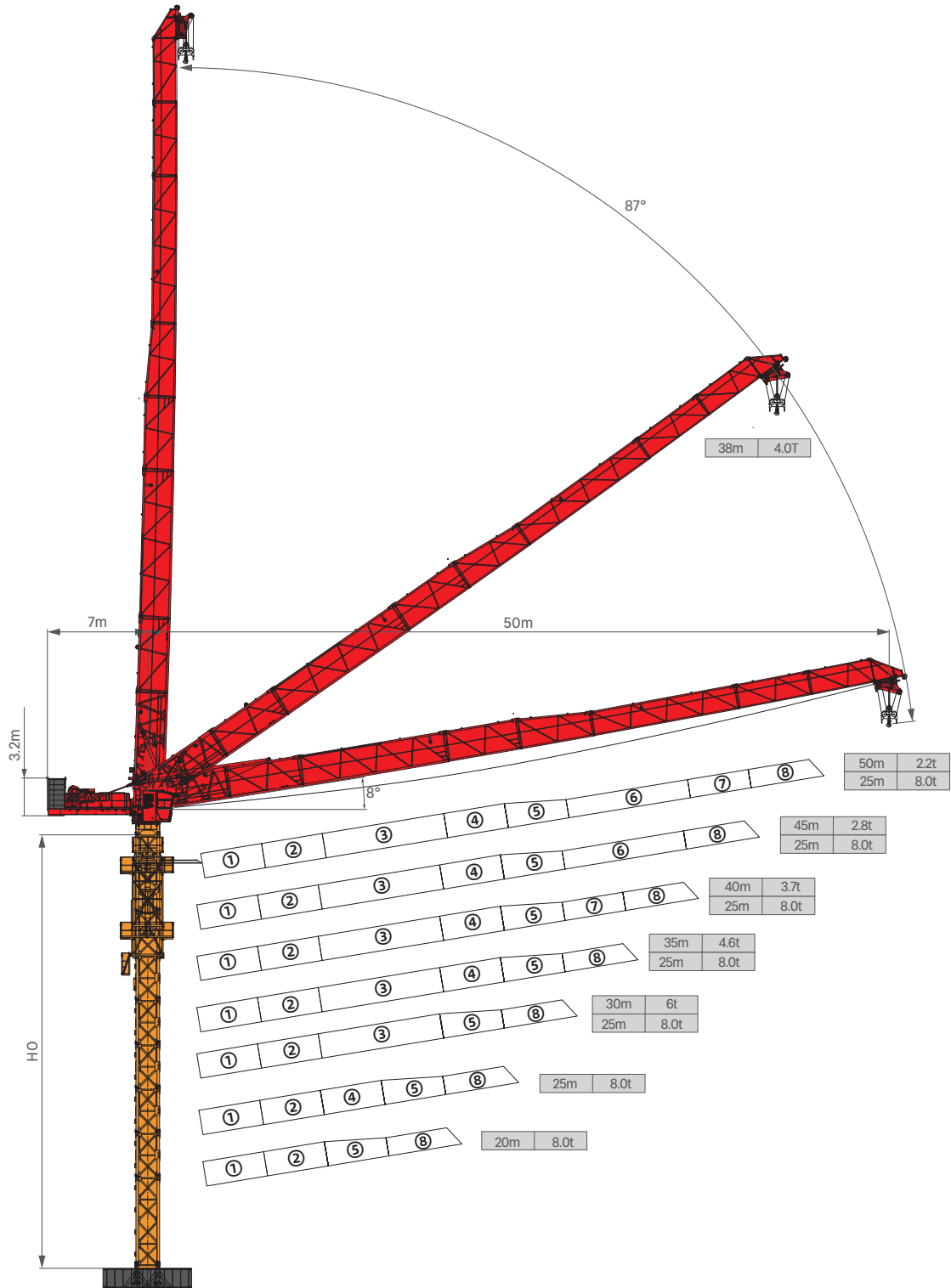

Flat top Jib Length & Tip Load 平头臂长组合及吊重



In-service lifting capacity parameters of luffing tower crane 动臂工况起重性能参数表

radius/m 幅度 (m)	the max. capacity/t 最大起重量 (m/t)	20	25	27	30	32	35	37	40	42	45	47	50
50	☺ 3.4-38m 4t				4				3.68	3.33	2.86	2.58	2.2
	☹ 3.4-25m 8t	8		7.17	6.07	5.46	4.66	4.21	3.61	3.26	2.79	2.51	2.13
45	☺ 3.4-38m 4t				4				3.68	3.33	2.8		
	☹ 3.4-25m 8t	8		7.17	6.07	5.46	4.66	4.21	3.61	3.26	2.79		
40	☺ 3.3-38m 4t				4				3.7				
	☹ 3.3-25m 8t	8		7.17	6.07	5.46	4.66	4.21	3.61				
35	☺ 3.2-35m 4t				4								
	☹ 3.2-25m 8t	8		7.17	6.07	5.46	4.66						
30	☺ 3.0-30m 4t				4								
	☹ 3.0-25m 8t	8		7.17	6.07								
25	☺ 2.8-25m 4t	4											
	☹ 2.8-25m 8t	8											
20	☺ 2.5-25m 4t	4											
	☹ 2.5-20m 8t	8											

In-service lifting capacity curve of luffing crane 动臂工况起重性能曲线图

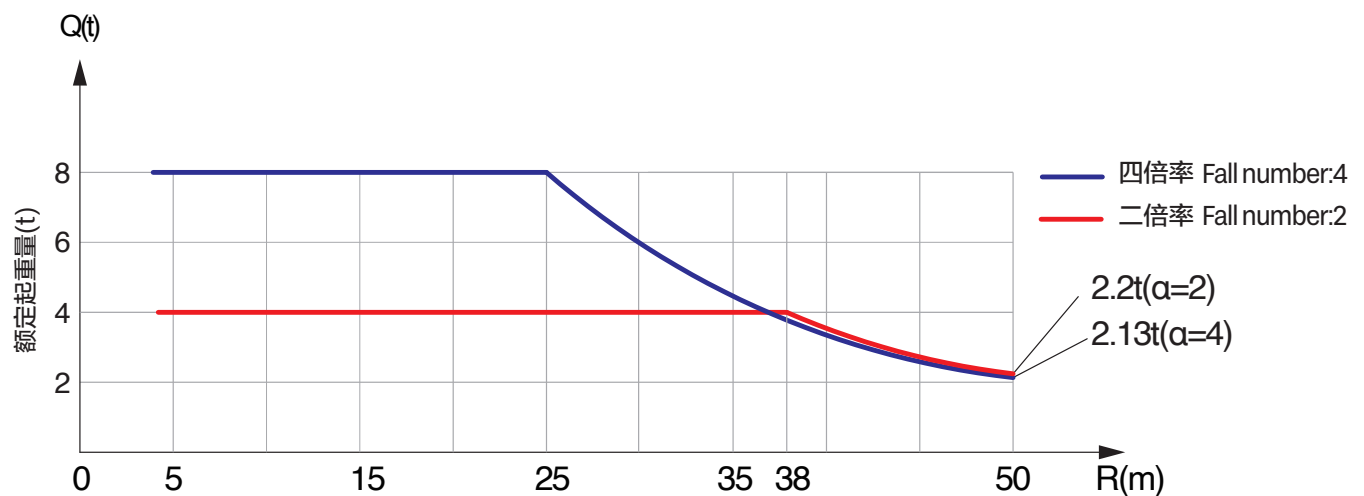

In-service lifting capacity parameters of flat-top tower crane 平头工况起重性能参数表

radius/m 幅度 (m)	the max. capacity/t 最大起重量 (m/t)	15	20	25	27	30	32	35	37	40	42	45	47	50
50	☺ 2.5-31m 4t			4			3.92	3.51	3.27	2.96	2.78	2.54	2.39	2.2
	☺☺ 2.5-17m 8t	8	6.71	5.18	4.73	4.16	3.85	3.44	3.20	2.89	2.71	2.47	2.32	2.13
45	☺ 2.5-33m 4t				4			3.84	4.07	3.29	3.06	2.8		
	☺☺ 2.5-18m 8t	8	7.29	5.65	5.16	4.56	4.21	3.77	4.00	3.19	2.99	2.73		
40	☺ 2.5-37m 4t					4				3.7				
	☺☺ 2.5-20m 8t	8	6.32	5.82	5.15	4.77	4.28	4	3.63					
35	☺ 2.5-35m 4t				4									
	☺☺ 2.5-22m 8t	8	6.91	6.34	5.62	5.21	4.69							
30	☺ 2.5-30m 4t				4									
	☺☺ 2.5-23m 8t	8	7.37	6.76	6.00									
25	☺ 2.5-25m 4t		4											
	☺☺ 2.5-25m 8t	8												
20	☺ 2.5-20m 4t	4												
	☺☺ 2.5-20m 8t	8												

In-service lifting capacity curve of flat-top crane 平头工况起重性能曲线图

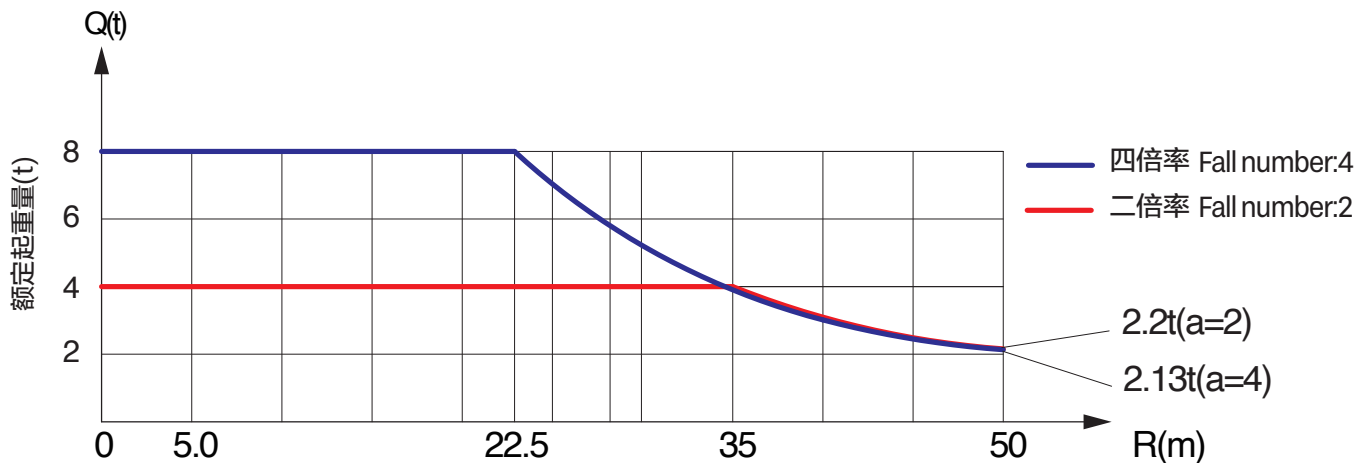

Roof crane table 屋面吊变幅表

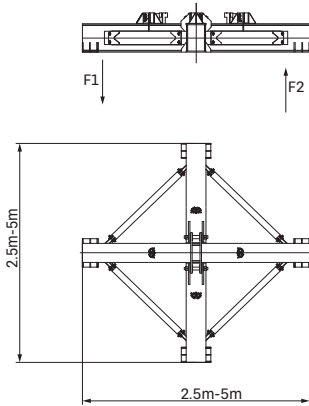
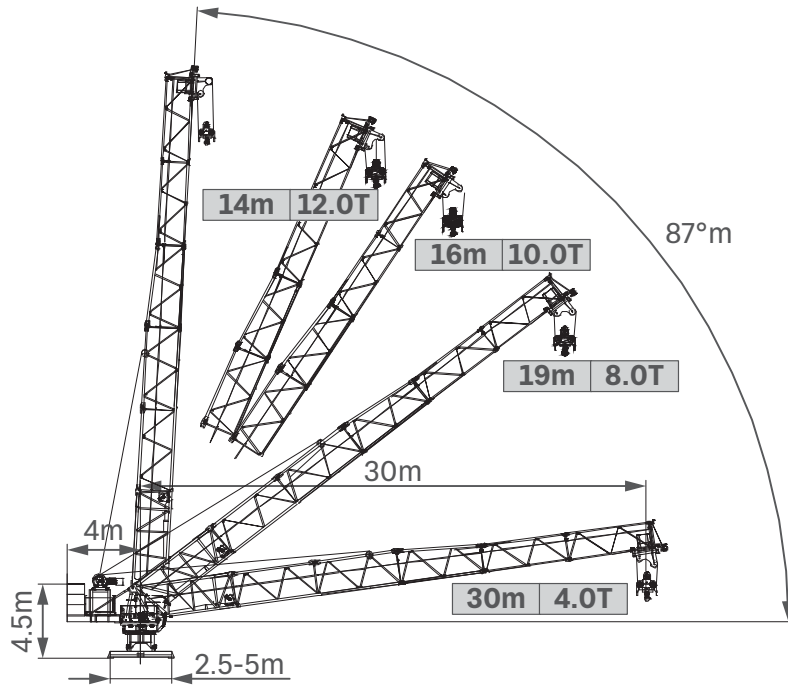

F1	35t-65t
F2	23t-51t
Excluded 配重	10.5t
Machine Deadweight (30m jib length, counterweight excluded) 整机自重(30m 臂长、不含配重)	24.5t

Roof crane base adjustable range 2.5m-5m, beyond the range, please contact the manufacturer
屋面吊底座可调范围 2.5m-5m, 超出范围请与厂家联系



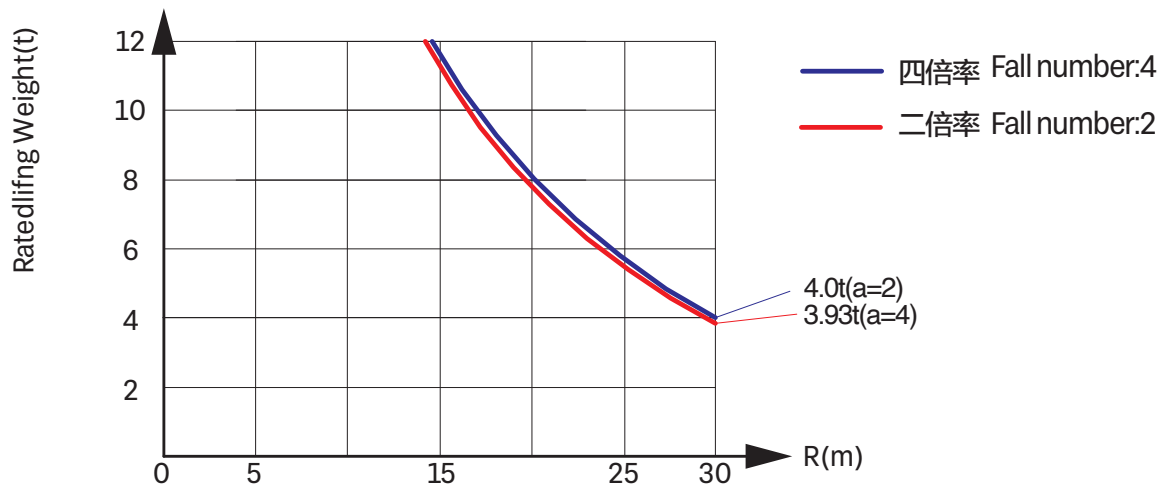

In-service lifting capacity parameters of roof crane 屋面吊工况起重性能参数表

radius/m 幅度 (m)	the max. capacity/t 最大起重重量 (m/t)	15	20	25	27	30
30	2.5-30m 4t			4		
	2.5-14m 12t	12	7.5	5.4	4.8	3.93
25	2.8-25m 4t		4			
	2.8-14m 8t	12	7.2	5.4		
20	2.5-20m 4t		4			
	2.5-20m 8t	12	8			

In-service lifting capacity curve of roof crane 屋面吊工况起重性能曲线图



Transmission Mechanisms 传动机构

Transmission 传动	Legend 图例	Model 型号	Power 功率	Velocity 速度
Slewing 回转		YPWEF112SL-4F1 YPWEF112SL-4F2	2 × 5.5Kw	0-0.7r/min
Luffing 拉臂变幅		YZTP30M3-4	30KW	≤2min (Cylinder luffing 油缸变幅)
Luffing of trolley 小车变幅		YVFE112M-4	4Kw	0-60m/min (Full variable frequency 全变频)
Hoisting 起升		YZTPF45QP-4	45Kw	0-106m/min
Power supply 电源电压		380V/440V(± 10%)	Power frequency 电源频率	50Hz/60Hz

Counter weight combination 配重组合

The max. working radius 最大工作幅度	Jib combination 臂节组合方式	Counter weight combination (t) 配重组合 (t)
50m	①②③④⑤⑥⑦⑧	1 × 4.5t+5 × 3t=19.5t
45m	①②③④⑤⑥⑧	1 × 4.5t+5 × 3t=19.5t
40m	①②③④⑤⑦⑧	1 × 4.5t+5 × 3t=19.5t
35m	①②③④⑤⑧	1 × 4.5t+4 × 3t=16.5t
30m	①②③⑤⑧	1 × 4.5t+4 × 3t=16.5t
25m	①②④⑤⑧	1 × 4.5t+3 × 3t=13.5t
20m	①②⑤⑧	1 × 4.5t+3 × 3t=13.5t

Anchorage (jib length of 50m) 附着 (50m臂长) 塔身 1.6m×1.6m×3m

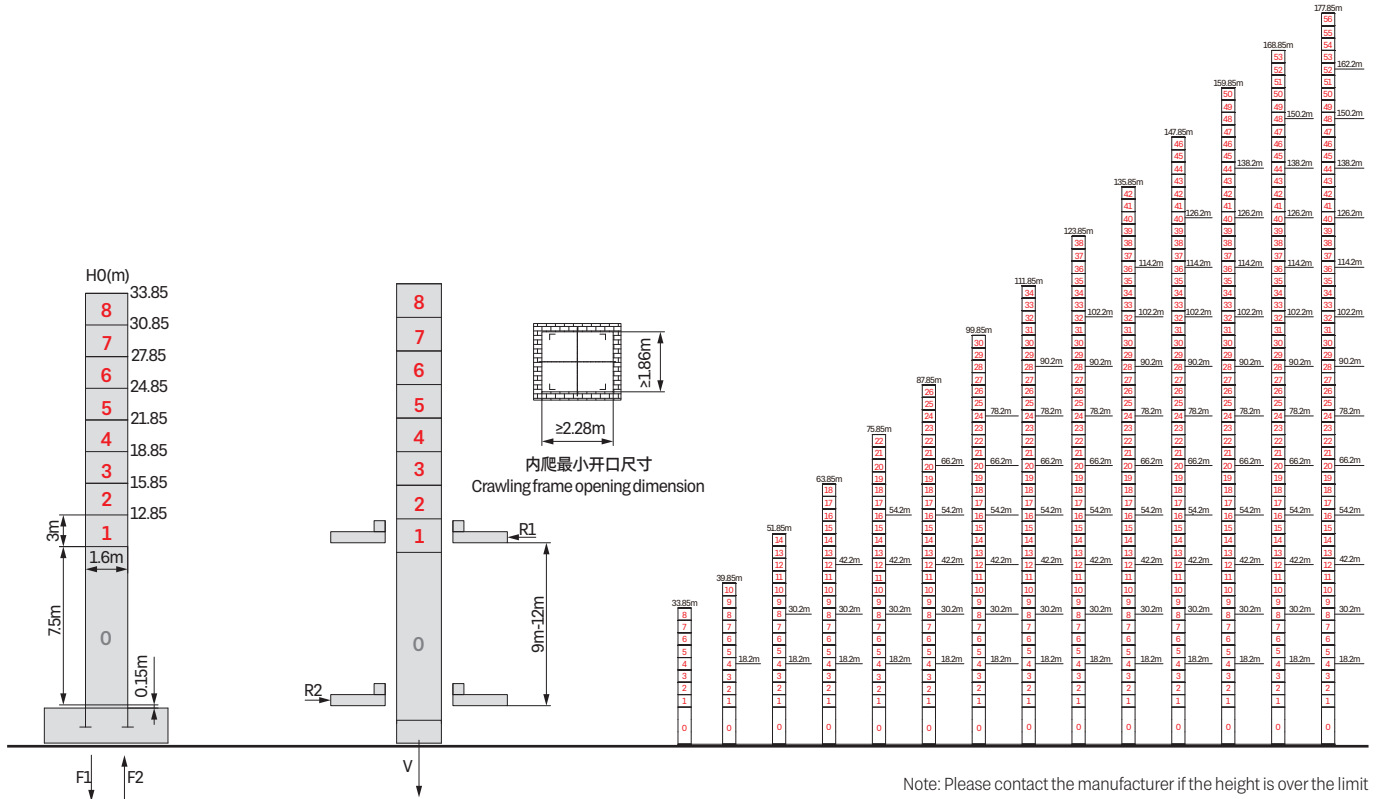

Note: Please contact the manufacturer if the height is over the limit

注：超出图中高度请联系厂家

Fixing tower mast
固定式塔身

Interior climbing tower mast
内爬式塔身

Fixing tower mast 固定式塔身

F1	Reactions in service 工作工况	138t
	Reactions out of service 非工作工况	141t
F2	Reactions in service 工作工况	108t
	Reactions out of service 非工作工况	120t
Freestanding height, dead weight at the max. jib (without counter weight, lifting weight nor ballast) 独立高度, 最长起重臂时自重(不含平衡重、吊重、压重)		42.6t

Interior climbing tower mast 内爬式塔身

R1	Reactions in service 工作工况	38t
	Reactions out of service 非工作工况	36t
R2	Reactions in service 工作工况	28t
	Reactions out of service 非工作工况	30t
V		67.1t

Anchorage (jib length of 50m) 附着(50m臂长)塔身1.8m×1.8m×2.8m

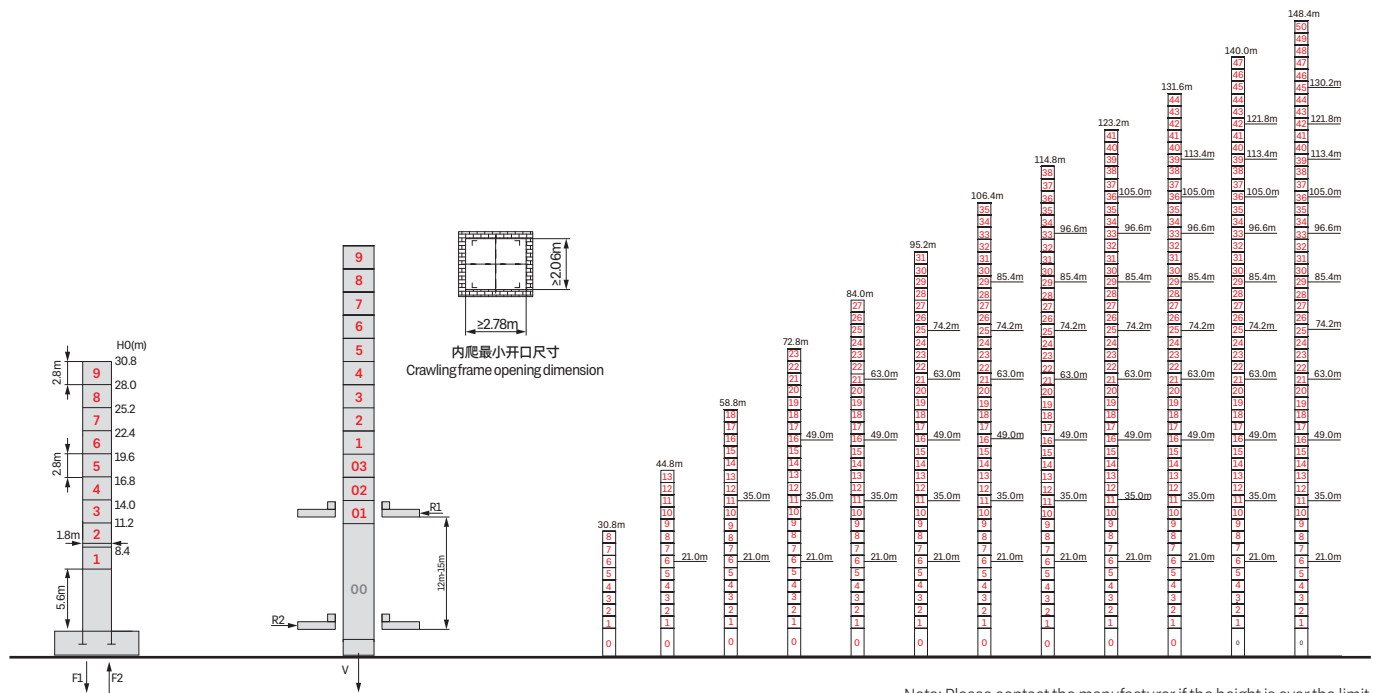

Note: Please contact the manufacturer if the height is over the limit
注：超出图中高度请联系厂家

Fixing tower mast
固定式塔身

Interior climbing tower mast
内爬式塔身











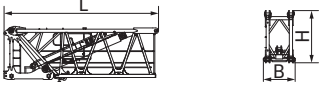

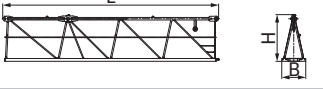

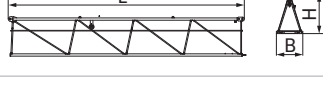
Fixing tower mast 固定式塔身

F1	Reactions in service 工作工况	133t
	Reactions out of service 非工作工况	198t
F2	Reactions in service 工作工况	96t
	Reactions out of service 非工作工况	158t
Freestanding height, dead weight at the max. jib (without counter weight, lifting weight nor ballast) 独立高度, 最长起重臂时自重(不含平衡重、吊重、压重)		45.3t

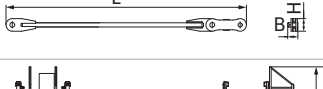

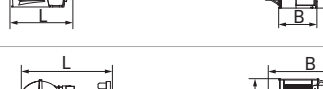







Interior climbing tower mast 内爬式塔身

R1	Reactions in service 工作工况	32t
	Reactions out of service 非工作工况	30t
R2	Reactions in service 工作工况	25t
	Reactions out of service 非工作工况	27t
V		71.2t

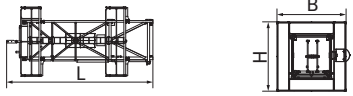
Packing List 运输部件

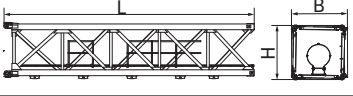
NO. 序号	Description 名称	Sketch 简图	L(m) 长	B(m) 宽	H(m) 高	Weight of single piece 单件重量 (t)	Q.T.Y 数量
1	Luffing jib 变幅节		6.65	1.30	2.25	7.35	1
2	Jib section II 臂节 II		5.23	1.135	2.31	1.01	1
3	Jib section III 臂节 III		10.205	1.135	2.209	1.52	1
4	Jib section IV 臂节 IV		5.2	1.135	2.16	0.60	1
5	Jib section V 臂节 V		5.2	1.135	2.518	0.55	1
6	Jib section VI 臂节 VI		10.16	1.135	1.72	0.89	1
7	Jib section VII 臂节 VII		5.15	1.135	1.72	0.33	1
8	Jib section VIII 臂节 VIII		6.63	1.135	1.72	0.47	1
9	Counter jib 平衡臂		5.73	1.36	0.75	2.11	1
10	Counter jib rod 平衡臂拉杆		3.775	0.145	0.18	0.124	2
11	Trolley 变幅小车		2.1	2.02	1.85	0.5	1
12	Hook 吊钩		1.05	0.25	2.36	0.32	1
13	Cab 司机室		2.28	1.41	2.18	0.400	1
14	Hoisting Mechanism 起升机构		2.22	1.92	1.26	2.5	1
15	Trolleying mechanism 小车变幅机构		1.12	0.56	0.59	0.35	1
16	Luffing pump station 拉臂泵站		2.01	1.48	1.004	2.2	1

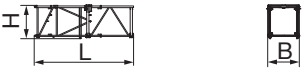
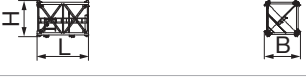
Packing List 运输部件

NO. 序号	Description 名称	Sketch 简图	L(m) 长	B(m) 宽	H(m) 高	Weight of single piece 单件重量 (t)	Q.T.Y 数量
17	Slewing support assembly 回转支座总成		2.3	1.63	2.1	3.5	1
18	Counter weight A 配重块 A		3.5	0.97	1.0	4.5	1
19	Counter weight B 配重块 B		3.5	0.41	1.0	3.0	5
Masts (Chip mast section) 1.6m 塔身 (片标)							
20	Transition section 过渡节		4.66	2.1	2.44	1.34	1
21	Telescoping cage 爬升架		7.6	3.53	3.53	3.32	1
22	Standard section 标准节		3.24	1.73	1.67	1.25	8
23	Basic mast 基础节		7.74	1.73	1.67	6.198	1
Masts (Integral mast section) 1.8m 塔身 (整标)							
24	Transition section 过渡节		2.83	2.43	2.43	1.351	1
25	Telescoping cage 爬升架		6.156	2.304	2.264	2.304	1
26	Reinforced section 加强节		2.8	1.96	1.96	1.049	9
27	Basic mast 基础节		5.63	2.13	2.13	2.098	1



SANY GROUP CRANE BU

SANY Tower Crane Industrial Park, No.168 Jinzhou Avenue, Jinzhou Development Zone, Changsha City, Hunan Province, P.R. China Zip 410600
Consulting sanycrane@sanygroup.com (Crane BU) / crd@sany.com.cn (IHQ)
After-sales Service 0086-400 6098 318

Reminder:

Any change in the technical parameters and configuration due to product modification or upgrade may occur without prior notice. The machine in the picture may include additional equipment. This brochure is for reference only, and goods in kind shall prevail.

Copyright at SANY. No part of this brochure may be copied or used for any purpose without written approval from SANY.

© Edited in June 2023

三一集团起重事业部

中国湖南长沙金洲开发区金洲大道168号三一塔式起重机产业园 邮编: 410600
咨询: sanycrane@sanygroup.com (起重事业部) / crd@sany.com.cn (国际总部)
海外售后服务: 0086-400 6098 318

温馨提示:

由于技术不断更新, 技术参数及配置如有更改, 恕不另行通知。图中机器可能包括附加设备, 本画册仅供参考, 以实物为准。
版权为三一所有, 未经三一书面许可, 本画册任何内容不得被复制用于任何目的。

© 2023 年 6 月版

