

SANY[®]

SPECIFICATION



 13.6t

 16.5m

 21.1m

SIC130

EXCELLENT ASSISTANT
FOR IN-PLANT MAINTENANCE

V1.1

QUALITY CHANGES THE WORLD

www.sanyglobal.com

It is one of the core business units in SANY Group, specializing in the development and manufacturing of high-end wheel cranes, crawler cranes and tower cranes, including the complete range of wheel cranes from 8 to 2400t, crawler cranes from 25 to 4500t and tower cranes from 6 to 185t.

三一集团旗下核心事业部，从事高端轮式起重机、履带起重机、塔式起重机系列产品的研发制造。覆盖8-2400吨全吨位轮式起重机，25-4500吨全吨位履带起重机，6-185吨塔式起重机。



SANY CRANE



Working in narrow spaces

狭窄空间作业

Overall height of 2.5m, width of 2.39m, easily fits through factory buildings dockyard.

New single-stage oblique outriggers, strong adaptability to different terrains.

All-wheel steering with a minimum steering radius of 4m, approach angle and departure angle 20°, strong accessibility.

Three-position mechanically offset (0°, 15° and 30°) of boom nose. The superstructure allows free slewing, enabling precise operation in narrow spaces such as building windows.

整机高度 2.5m, 宽度 2.39m, 可轻松通过厂房、石化管廊、码头堆场等狭窄区域;

全新八字腿结构, 场地适应性强;

全轮转向, 最小转弯半径 4m, 接近角和离去角 20°, 通过性强;

配备可定位臂头, 0°, 15°, 30° 三种角度可选, 上车可自由回转, 可实现建筑窗户等狭窄空间的高空精准递送。

Strong lifting capability

超强起重性能

Hexagonal large-section 4-section boom with 16.5m full-extension boom and 4.6m standard jib, max. lifting height 20.1m, leading configuration in the industry.

Max. lifting moment of basic boom 334kN.m, max. lifting capacity of full-extension boom 5.5t, working radius 1.8m-15.4m, leading performance in the industry.

3.7m transverse outrigger span, 2.28t counterweight, comprehensive leading capacity in the industry.

六边形形大截面 4 节主臂, 主臂全伸长 16.5m, 标配 4.6m 副臂, 最大起升高度 20.1m, 配置领先;

正前方吊载第 2 个臂段最大起重力矩 334kN.m, 全伸主臂最大起重量 5.5t, 主臂工作幅度 1.8m-15.4m, 性能领先;

3.7m 横向支腿跨距, 配重 2.28t, 全面领先的吊载能力。

**EXCELLENT ASSISTANT
FOR IN-PLANT MAINTENANCE
SIC130 / 13.6T LIFTING CAPACITY**



Traveling with load

带载行走功能

The crane is able to travel with 5.2t load at dead front on its base boom.

可在正前方,基本臂情况下带载 5.2 吨行走,行驶速度不高于 4Km/h,可覆盖 Pick & Carry 部分工况。

Multiple working condition options

多工况选择

Selectable boom, jib, traveling with load and others working configurations.

Steel walking surfaces and stepping surfaces, capable of short-distance handling and self-loading/unloading within the factory area, saving one flatbed truck.

可选择主臂、副臂、轮胎吊载、带载行走等多种工况；
备货舱甲板,可实现厂区内短距离货物搬运和自装卸,节省 1 辆平板车。

Brand-new driving experience

全新驾乘体验

A brand-new control cab with ample space, equipped with heating and air conditioning, rubber dampers for shock absorption, providing excellent comfort.

Front rigid suspension and rear oscillation suspension. It can adapt to various harsh working conditions and road surfaces, ensuring smooth vehicle operation and stability against rollovers.

Equipped with multi-directional, high-definition cameras with a large field of vision for optimal operational visibility.

全新操纵室,空间大,带冷暖空调,橡胶垫减震,舒适性好；
前桥刚性、后桥摆动悬架设计,能适用各种恶劣工况和路面,保证车辆行驶的平顺性和侧翻稳定性；
配备多方位、大视野高清摄像头,作业视野好。



Overall Dimensions

整机尺寸

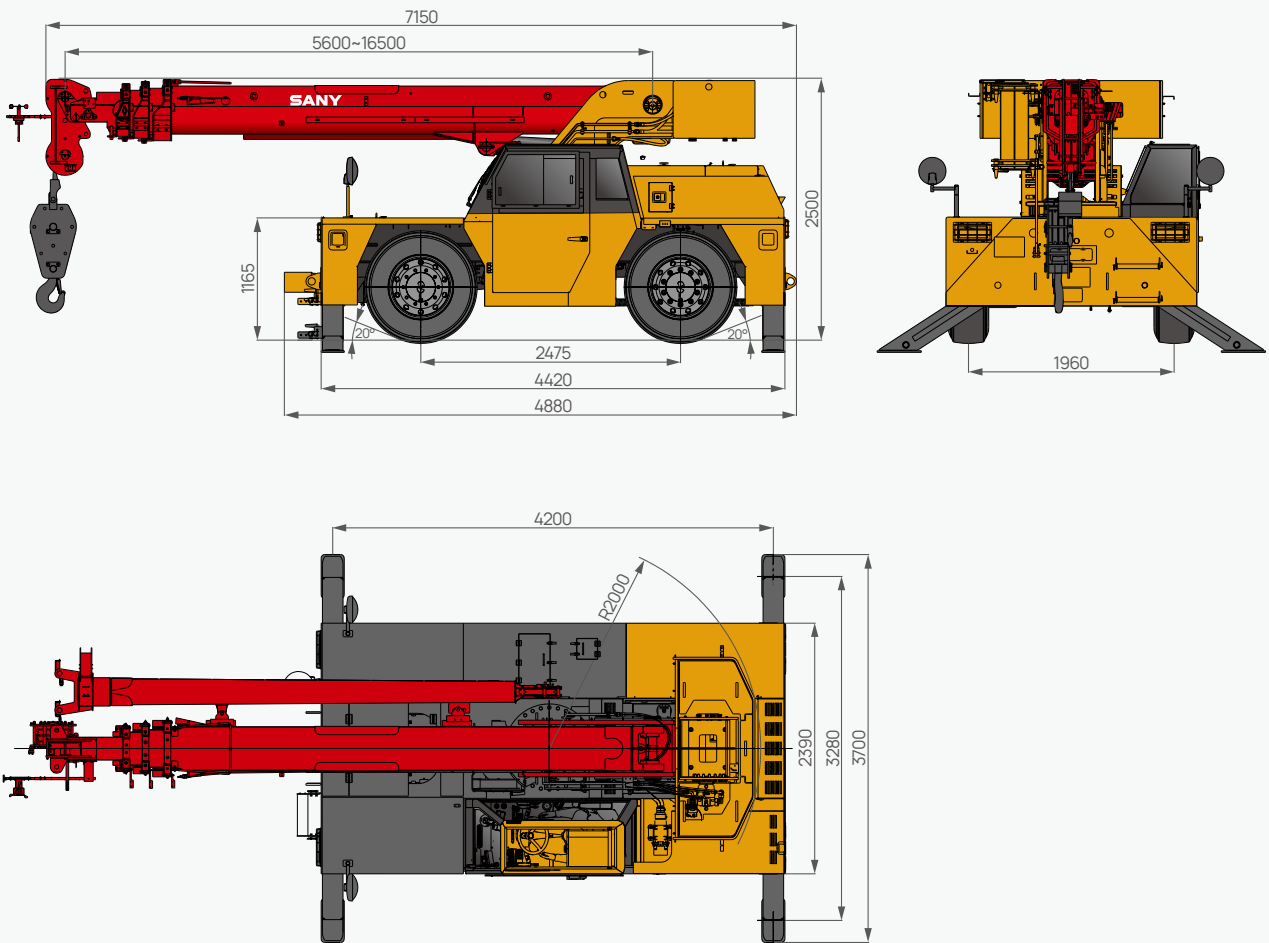

Technical Specification

整机参数

CATEGORY 类型	ITEM 项目	UNIT 单位	VALUE 参数	
CAPACITY 额定起重量	Max. rated lifting capacity 最大额定总起重量	t	13.6	
WEIGHT 重量参数	Gross weight 整机总质量	kg	14500	
	Fixed counterweight 固定配重	kg	2280	
POWER 发动机参数	Engine model 发动机型号 (排放标准)	-	US Cummins QSF3.8(Euro III/Euro V) QSF3.9(China IV) 美康 QSF3.8 (欧三 / 欧五) 东康 QSF3.9 (国 IV)	
	Max. engine power 发动机最大功率	kW/rpm	93/2200(QSF3.8) 81/2500(QSF3.9)	
	Max. engine torque 发动机最大输出扭矩	N·m/rpm	500/1320(QSF3.8) 480/1600(QSF3.9)	
DIMENSIONS 尺寸参数	Overall length 整机长度	mm	7150	
	Overall width 整机宽度	mm	2390	
	Overall height 整机高度	mm	2500	
	Wheelbase 轴距	mm	2475	
	Track width 轮距	mm	1960	
	Min. steering radius 最小转弯半径	m	4.0	
	Turntable tail slewing radius 转台尾部回转半径	mm	2000	
TRAVEL 行驶参数	Max. travel speed 最高行驶速度	km/h	30	
	Approach angle 接近角	°	20	
	Departure angle 离去角	°	20	
	Max.gradeability 最大爬坡度	-	57%	
MAIN PERFORMANCE 主要性能参数	Min.rated lifting radius 最小额定幅度	m	1.8	
	Max.lifting moment 最大起重力矩	Main boom 主臂	kN·m	334
		Full-extension boom 全伸主臂	kN·m	298
		Full-extension boom + jib 全伸主臂 + 副臂	kN·m	191
	Boom length 臂长	Basic boom 基本臂	m	5.6
		Full-extension boom 全伸主臂	m	16.5
		Full-extension boom + jib 全伸主臂 + 副臂	m	21.1
	Max.lifting height 最大起重高度	Basic boom 基本臂	m	5.5
		Full-extension boom 全伸主臂	m	16.0
		Full-extension boom + jib 全伸主臂 + 副臂	m	20.6
Outrigger span (Longitudinal × Transverse) 支腿跨距 (纵 × 横)	m	4.2 × 3.28		
Adjustable boom nose 可变位臂头	°	0/15/30		

Technical Specification

整机参数



Axle Load 轴荷

Axle 轴	1	2	Gross weight 总重量
Axle load 轴荷 /kg	7520	6980	14500
Remark 备注	Full configuration, with one operator. 全配, 含一名驾驶员		



Hook 吊钩

Rated load 额载 /t	Number of sheaves 滑轮数量	Rope rate 倍率	Hook weight/kg 吊钩重量
13.6	2	4	160
5	-	1	80



Operations 主要动作参数

Item 项目	Max.single rope lifting speed (empty load) 单绳速度 (空载)	Rope diameter/length 钢丝绳直径 / 长度	Max. single line pull 最大单绳拉力
Winch speed 卷扬速度	0-50m/min	Φ14mm/100m	4t
Slewing speed 回转速度	0-2.1r/min		
Full luffing up/down time of boom 主臂起落幅时间	25/15s		
Full extension/retraction time of boom 主臂伸缩时间	23/22s		

Crane Introduction

整机介绍

Carrier 下车

Driver's cab 驾驶室

- Sany independently developed cab, designed based on ergonomic principles, with excellent shock absorption and sealing properties. It is equipped with a two-point safety belt, an adjustable multifunction steering wheel, and automatic heating and cooling air conditioning. 10.1-inch display screen, providing a comprehensive view of the vehicle's status. The button panel is fully functional, enhancing the driving experience for comfort, safety, and user-friendliness.
- 三一自主研发，采用人体工程学原理设计，减震性和密封性优良。配备二点安全带、可调节式的多功能方向盘、冷暖空调。配置 10.1 寸显示屏，整车状态一览无余，按面板功能齐全，驾乘体验更加舒适、安全、人性化。

Carrier frame 车架

- Sany double longitudinal beam construction welded by high-strength fine-grained high-strength steel plate, higher bearing capacity and longer service life.
- 三一自主设计、制造的高强度细晶粒高强度钢板焊接而成的双纵梁型车架结构，承载能力强，使用寿命长。

Axle 车桥

- All-wheel steering, with the front axle serving as the driving axle, offers light and flexible steering, thereby enhancing maneuverability and agility.
- 全轮转向，前桥为驱动桥，转向轻便灵活，操纵性与机动性更加优越。

Engine 发动机

- Model: In-line four-cylinder diesel engine with watercooler and inter cooler.
- Environmental-friendly: Cummins engines can provide emission power solution tailored to the needs of different countries and regions, meeting the emission standards of China Stage IV, and Euro Stage III/Stage 4.
- Fuel reservoir capacity: 150L.
- 发动机：直列四缸，水冷却，增压中冷，柴油发动机。
- 环保性：康明斯发动机能够提供适应不同国家和地区需求的“一站式”排放动力解决方案，满足中国第四阶段、欧洲 Stage 3/Stage 5 排放标准。
- 燃油箱容积：150L。

Transmission 变速箱

- Integrated Manual and Automatic Transmission, 3 forward gears and 3 reverse gears. Smooth gear shifting.
- 手自一体变速箱，3 个前进挡、3 个后退挡，换挡平顺。

Suspension system 悬挂系统

- Front axle suspension and rear axle with cylinder locking pivot swing suspension.
- 前桥刚性，后桥带油缸锁定枢轴摆动悬挂。

Steering 转向系统

- Hydraulic cylinder steering.
- Equipped with multiple steering modes to achieve higher maneuverability, and the minimum steering radius is 4.0m.
- 前后桥为液压油缸推动转向，液压助力。
- 多种转向模式实现更高的机动性，最小转弯半径 4.0m。

Braking 制动系统

- The braking system includes service brake & parking brake.
- Wet-type brakes offer rapid braking response and high braking efficiency.
- 制动系统包括行车制动和驻车制动。
- 湿式制动器，制动响应快，制动效能高。

Wheel formula 车轮模式

- 4 × 2.

Outrigger 支腿

- Single-stage oblique outriggers, strong adaptability to different terrains.
- Axle articulation structure with adjustable angles to adapt to different ground conditions.
- 活动支腿使用八字形支腿，适用狭小工作空间。
- 支脚采用铰接结构，可调角度以适应地面工况。

Tires 轮胎

- 385/65R22.5

Electrical system 电气系统

- Utilizing an internationally advanced distributed integrated bus data communication network, the system ensures high-speed information transmission with a response time of less than 20ms.
- Equipped with a 10.1-inch high-definition display screen featuring a new user interface. Various work statuses can be displayed through button indicator lights.
- Sany independently developed a Load Moment Indicator with precision up to 0-5%.
- The winch camera monitors the winch operation, promptly detecting any rope disorder problem.
- 国际先进的分布式集成总线数据通信网络，高速信息传输、响应速度小于 20ms。
- 采用 10.1 寸高清显示屏，全新操作界面。可通过按键指示灯显示各种工作状态。
- 三一自主研发的力矩限制器系统，精度达 0-5%。
- 卷扬摄像头监视卷扬工作及时发现乱绳的情况。

Crane Introduction

整机介绍

superstructure 上车



Boom system 臂架系统

- Boom: Four-section, basic boom 5.6m, full-extension 16.5m, made of fine-grained high-strength welded steel plates. Single cylinder telescoping with rope arranger functioning automatic telescoping, with a double-acting cylinder that can control the extension and retraction of all boom sections, achieving various combinations of boom lengths.
- Jib: 4.6m jib with adjustable jib head, offset at 0°, 15°, 30°.
- 主起重臂: 4节臂, 基本臂长 5.6m, 全伸臂长 16.5m。采用细晶粒高强度钢板折弯、焊接制成, 单缸绳排伸缩机构, 一个双作用油缸可以控制所有吊臂的伸缩, 达到多种臂长组合。
- 副臂: 副臂长 4.6m, 配备可变位臂头, 0°, 15°, 30° 三种角度可选。



Slewing platform 转台结构

- SANY independently developed, made of fine grain high strength steel in optimized structure.
- 三一自主设计, 结构更优化。由细晶粒高强度钢制成。



Hydraulics 液压系统

- Load-sensitive superstructure hydraulic system, achieving high-precision flow control to maximize energy efficiency. The boom extension and retraction system uses an open system composed of an electronically controlled proportional pump and a proprietary main valve. The hoist and winch systems, as well as the slewing system, adopt open systems.
- All key components, including hydraulic pumps, piston motors, and balance valves, are sourced from top-tier international brands, ensuring high quality and reliability. Sany's independently developed double pump intelligent flow distribution system.
- 负载敏感液压系统, 实现高精度流量控制, 减少能量浪费。变幅、伸缩、卷扬、回转采用开式系统。
- 采用国际一线品牌的液压泵、柱塞马达及平衡阀等关键元件均, 品质好, 可靠性高。



Hoist 起升机构

- High-quality wire rope locks enhances the efficiency of changing the wire rope ratio, making it convenient and swift.
- Specifications: φ 14, 35WxK7 anti-rotation steel wire rope.
- Max. single rope speed: 50m/min.
- 采用高品质钢丝绳锁, 提高了起重倍率的更换速度, 方便快捷。
- 钢丝绳规格: φ 14, 35WxK7 抗旋转钢丝绳。
- 最大单绳速度: 50m/min。



Luffing system 变幅系统

- Luffing angle: 0°~75°, electric proportional control, combining power luffing with passive luffing, it can achieve rapid luffing at large angles and stable, slow-speed luffing at small angles.
- 变幅角度 0°~75°, 动力落幅和自重落幅相结合, 可实现大角度快速落幅, 小角度稳定慢速落幅。



Slewing 回转系统

- 360° slewing in both direction, max. speed 2.1 rpm. The slewing adopts a open system for stable braking.
- 360° 回转, 最大回转速度 2.1rpm; 回转采用开式系统, 制动可靠。



Control system 控制系统

- Powered by a 24V DC power supply, and controlled by a CAN-BUS control network.
- The system features real-time monitoring and automatic fault diagnosis capabilities.
- 24V 直流电源供电, CAN-BUS 总线控制网络。
- 具有系统实时监测和故障自动诊断功能。



Safety equipment 安全装置

- Analytical mechanics is applied and load moment indicator calculation system based on the hoisting mechanics model is established. Through online empty-load calibration, the rated accuracy can reach 0-5%.
- The hydraulic system includes balance valve, relief valve, two-way holding valve, etc. to realize system stability and reliability.
- The main and auxiliary winches are equipped with third-wrap indicators to prevent over-hoist-down of the wire rope.
- Boom head and jib head are equipped with A2B switches to prevent the wire rope from over winding.
- Boom head and jib head are equipped with anemometer to monitor whether the high-altitude wind speed exceeds the permissible operating range.
- 采用分析力学方法, 建立了基于吊重力学模型的力矩限制器计算系统, 通过在线空载标定, 吊重精度达到 0-5%。
- 液压系统配置液压平衡阀、溢流阀、双向液压锁等元件, 实现液压系统稳定可靠。
- 卷扬配置三圈保护器, 防止钢丝绳过放。
- 臂端配置高度限位器, 防止钢丝绳过卷。
- 臂端装有风速仪, 检测高空风速是否超过可作业允许范围。

Operating Range - Telescopic Boom (T)

起升高度曲线 - 主臂 + 副臂

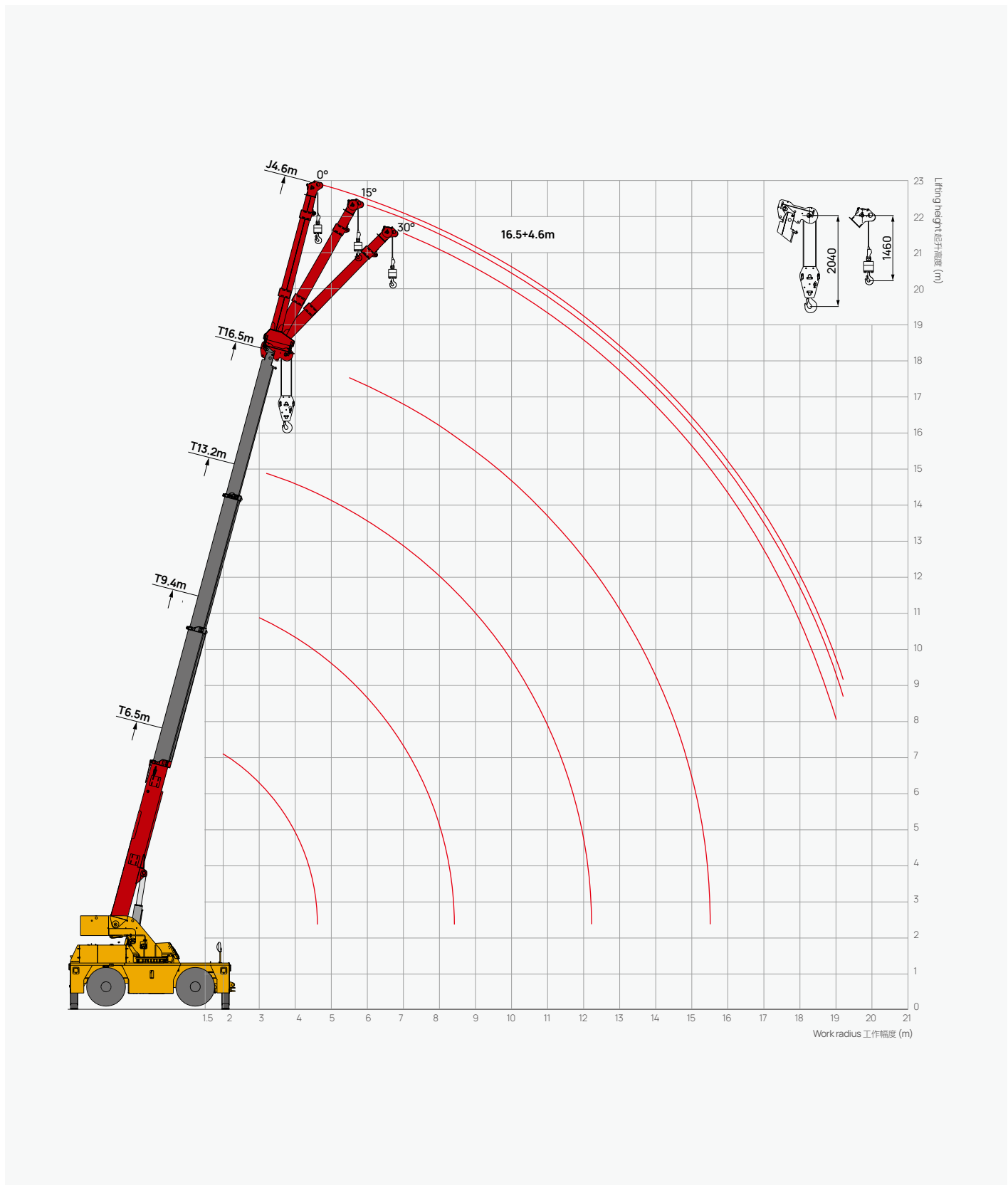





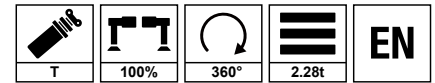

Load Chart - Telescopic Boom (T), 360° Slewing

性能表 - 主臂(360°)



Unit: kg





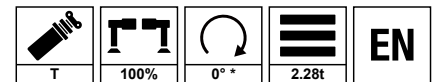

 m	5.6	9.4	13.2	16.5	 m
1.8	13600				1.8
2.4	11900				2.4
3	9800	7800			3
3.7	8600	7800			3.7
4.3	6200	7100	7000		4.3
4.9		5700	5800		4.9
5.5		4700	4700	4700	5.5
6.1		3800	4000	3900	6.1
6.7		3300	3400	3400	6.7
7.3		2900	3000	2900	7.3
7.9		2400	2600	2600	7.9
8.5			2300	2300	8.5
9.1			2000	2000	9.1
9.8			1800	1800	9.8
10.4			1600	1600	10.4
11			1400	1400	11
11.6			1200	1300	11.6
12.2				1200	12.2
12.8				1100	12.8
13.4				1000	13.4
14				900	14
14.6				800	14.6
15.2				700	15.2
15.4				600	15.4
 Min	0	0	0	0	 Min
 Min kg	3000	1500	800	300	 Min kg

Load Chart - Telescopic Boom (T), Load Over Front

性能表 - 主臂(正前方)



Unit: kg

 m	5.6	9.4	13.2	16.5	 m
1.8	13600				1.8
2.4	11900				2.4
3	9800	7800			3
3.7	8600	7800			3.7
4.3	6200	7500	7000		4.3
4.9		6800	6300		4.9
5.5		6200	5800	5500	5.5
6.1		5300	5200	5000	6.1
6.7		4500	4400	4400	6.7
7.3		3900	3800	3800	7.3
7.9		3000	3300	3300	7.9
8.5			3000	2900	8.5
9.1			2700	2600	9.1
9.8			2400	2300	9.8
10.4			2100	2100	10.4
11			1900	1900	11
11.6			1800	1700	11.6
12.2				1600	12.2
12.8				1500	12.8
13.4				1400	13.4
14				1300	14
14.6				1200	14.6
15.2				1100	15.2
15.4				1000	15.4
 Min	0	0	0	0	 Min
 Min kg	3000	2000	1000	500	 Min kg

Load Chart - Telescopic Boom, On Tires Stationary, Load Over Front

性能表 - 轮胎静止吊载 (正前方)



Unit: kg









	5.6	9.4	13.2	16.5	
1.8	7100				1.8
2.4	5800				2.4
3	4800	4800			3
3.7	3500	3700			3.7
4.3	2700	2900	3000		4.3
4.9		2300	2400		4.9
5.5		1900	2000	2000	5.5
6.1		1600	1700	1700	6.1
6.7		1400	1400	1500	6.7
7.3		1200	1200	1300	7.3
7.9		1000	1100	1100	7.9
8.5			900	1000	8.5
9.1			800	800	9.1
9.8			700	700	9.8
10.4			600	600	10.4
11			500	500	11
11.6			400	500	11.6
12.2				400	12.2
12.8				400	12.8
13.4				300	13.4
14				300	14
	0	0	18	25	
	1500	500	300	200	
	75	75	75	75	

Load Chart - Telescopic Boom, On Tires Stationary, 360° Slewing

性能表 - 轮胎静止吊载 (360°)



Unit: kg

 m	5.6	9.4	13.2	16.5	 m
1.8	6400				1.8
2.4	4600				2.4
3	3200	3400			3
3.7	2300	2500			3.7
4.3	1800	1900	2000		4.3
4.9		1600	1600		4.9
5.5		1300	1300	1500	5.5
6.1		1000	1100	1100	6.1
6.7		800	900	900	6.7
7.3		700	700	800	7.3
7.9		500	600	700	7.9
8.5			500	600	8.5
9.1			400	500	9.1
9.8			300	400	9.8
10.4			300	300	10.4
 Min ↓	0	20	30	46	 Min ↓
 Min ↓ kg	800	300	200	200	 Min ↓ kg
 Max ↓	75	75	75	75	 Max ↓

Load Chart - Telescopic Boom, Pick & Carry, Load Over Front

性能表 - 主臂带载行驶 (正前方)



Unit: kg





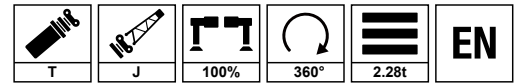

m	5.6	9.4	13.2	16.5	m
1.8	5200				1.8
2.4	4200				2.4
3	3500	3600			3
3.7	2900	3000			3.7
4.3	2400	2500	2600		4.3
4.9		2000	2200		4.9
5.5		1700	1800	1800	5.5
6.1		1400	1500	1500	6.1
6.7		1200	1300	1300	6.7
7.3		1000	1100	1200	7.3
7.9		900	1000	1000	7.9
8.5			800	900	8.5
9.1			700	800	9.1
9.8			600	600	9.8
10.4			500	500	10.4
11			400	500	11
11.6			300	500	11.6
12.2				400	12.2
12.8				400	12.8
13.4				300	13.4
	0	0	18	29	
	1200	400	200	200	
	75	75	75	75	

Load Chart - Fixed Jib

性能表-副臂

Unit: kg



	16.5+4.6			
	0°	15°	30°	
4.9				4.9
5.5				5.5
6.1	3200			6.1
6.7	2800			6.7
7.3	2600	2200		7.3
7.9	2400	2100	1700	7.9
8.5	2200	2000	1600	8.5
9.1	2100	1900	1600	9.1
9.8	1900	1800	1500	9.8
10.4	1700	1700	1500	10.4
11.0	1500	1600	1500	11.0
11.6	1400	1400	1400	11.6
12.2	1300	1300	1300	12.2
12.8	1200	1200	1200	12.8
13.4	1100	1100	1100	13.4
14.0	1000	1000	1000	14.0
14.6	900	900	900	14.6
15.2	800	800	800	15.2
15.8	700	700	800	15.8
16.5	700	600	700	16.5
17.1	600	600	600	17.1
17.7	500	500	500	17.7
18.3	500	500	500	18.3
18.9	400	400	400	18.9
	18	20	21	
	200	200	200	



SANY GROUP CRANE BU

SANY Mobile Crane Industrial Park, No.168 Jinzhou Avenue, Jinzhou Development Zone, Changsha City,
Hunan Province, P.R. China Zip 410600
Consulting sanycrane@sanygroup.com (Crane BU) / crd@sany.com.cn (IHQ)
After-sales Service 0086-400 6098 318

Reminder:
Any change in the technical parameters and configuration due to product modification or upgrade may occur without prior notice.
The machine in the picture may include additional equipment. This brochure is for reference only, and goods in kind shall prevail.
Copyright at SANY. No part of this brochure may be copied or used for any purpose without written approval from SANY.

© Edited in June 2024

三一集团起重事业部

中国湖南长沙金洲开发区金洲大道 168 号 三一汽车起重机产业园 邮编: 410600
咨询: sanycrane@sanygroup.com (起重事业部) / crd@sany.com.cn (国际总部)
海外售后服务: 0086-400 6098 318

温馨提示:
由于技术不断更新, 技术参数及配置如有更改, 恕不另行通知。图中机器可能包括附加设备, 本画册仅供参考, 以实物为准。
版权为三一所有, 未经三一书面许可, 本画册任何内容不得被复制用于任何目的。

© 2024 年 6 月版

