



Quality Changes The World

SFT315(T7527-20C5)

SANY Tower Crane
三一重工塔式起重机



Better World
Better SANY Crane

SANY CRANE



Jib Length & Tip Load 臂长组合及吊重 (2.0×2.0×3.0)

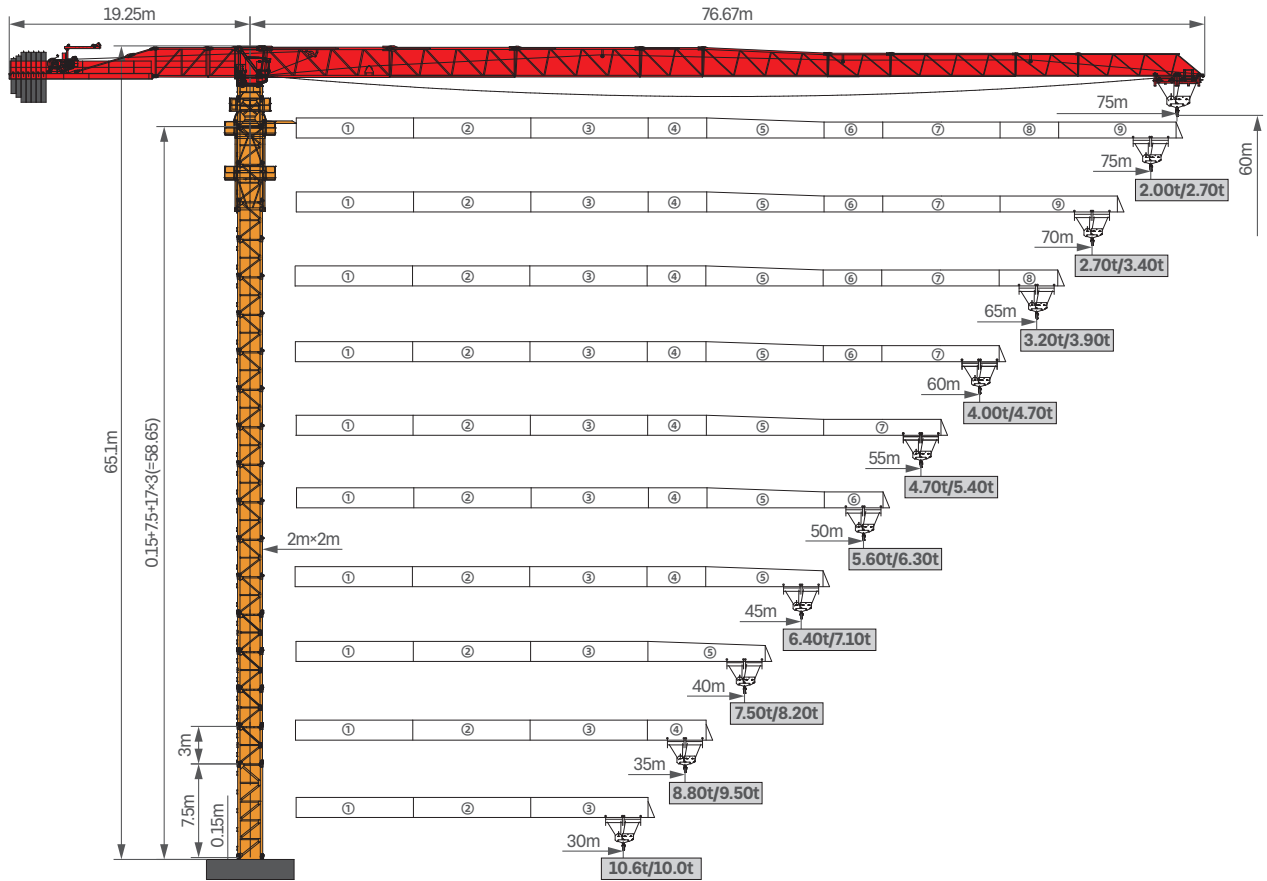





















Transmission Mechanisms 传动机构







Transmission 传动	Legend 图例	Model 型号	Power 功率	Velocity 速度
Slewing 回转		STH130B75P-12-15	2 × 7.5kw	0-0.7r/min
Trolleying 变幅		SXJ55.70P	11kw	0-75m/min
Hoisting 起升		55QP40	65kW(33Hz)	0-100m/min
Voltage 电源电压		380V(±10%), 50Hz		

Note: Contact with us when the rope capacity of hoisting mechanism is larger than 720m
注：工作容量大于720m时请与厂家联系

Load Diagrams 起重特性表

radius/m 幅度 (m)	the max. capacity/t 最大起重量	15	18	20	23	25	28	30	33	35	38	40	43	45	48	50	53	55	58	60	63	65	68	70	73	75
75	 4.5-26.37/10t	1000	1000	1000	1000	1000	9.33	8.61	7.69	7.17	6.50	6.11	5.60	5.29	4.88	4.64	4.31	4.10	3.83	3.66	3.43	3.29	3.09	2.97	2.80	2.70
	 3.5-13.92/20.0t	1772	14.44	12.81	10.88	9.86	8.60	7.89	7.00	6.49	5.83	5.44	4.92	4.62	4.21	3.96	3.63	3.43	3.15	2.98	2.75	2.60	2.40	2.28	2.10	2.00
70	 4.5-28.10/10t	1000	1000	1000	1000	1000	1000	9.30	8.35	7.82	7.11	6.70	6.16	5.84	5.40	5.15	4.79	4.58	4.29	4.11	3.86	3.71	3.50	3.40		
	 3.5-14.90/20.0t	19.67	16.07	14.27	12.16	11.03	9.64	8.87	7.89	7.33	6.60	6.17	5.61	5.27	4.82	4.55	4.18	3.96	3.66	3.47	3.21	3.06	2.84	2.70		
65	 4.5-29.50/10t	1000	1000	1000	1000	1000	1000	9.72	8.73	8.17	7.44	7.02	6.45	6.11	5.66	5.40	5.03	4.81	4.50	4.32	4.06	3.90				
	 3.5-15.60/20.0t	20.00	16.60	14.72	12.57	11.41	9.98	9.18	8.17	7.60	6.84	6.41	5.82	5.48	5.02	4.74	4.36	4.13	3.82	3.63	3.36	3.20				
60	 4.5-31.50/10t	1000	1000	1000	1000	1000	1000	1000	9.43	8.33	8.05	7.59	6.99	6.63	6.15	5.86	5.46	5.23	4.90	4.70						
	 3.5-16.50/20.0t	20.00	17.84	15.86	13.54	12.30	10.78	9.93	8.85	8.23	7.43	6.96	6.43	5.98	5.48	5.19	4.78	4.54	4.20	4.00						
55	 4.5-32.00/10t	1000	1000	1000	1000	1000	1000	1000	9.72	9.11	8.30	7.82	7.21	6.84	6.35	6.05	5.65	5.40								
	 3.5-16.90/20.0t	20.00	18.33	16.30	13.92	12.66	11.09	10.22	9.12	8.49	7.67	7.19	6.55	6.17	5.67	5.36	4.95	4.70								
50	 4.5-33.40/10t	1000	1000	1000	1000	1000	1000	1000	1000	9.47	8.63	8.15	7.50	7.12	6.61	6.30										
	 3.5-17.60/20.0t	20.00	18.99	16.89	14.44	13.13	11.52	10.62	9.48	8.83	7.98	7.48	6.83	6.43	5.91	5.60										
45	 4.5-33.40/10t	1000	1000	1000	1000	1000	1000	1000	1000	9.47	8.63	8.15	7.50	7.10												
	 3.5-17.60/20.0t	20.00	18.99	16.89	14.44	13.13	11.52	10.62	9.48	8.83	7.98	7.48	6.83	6.40												
40	 4.5-33.40/10t	1000	1000	1000	1000	1000	1000	1000	1000	9.47	8.63	8.20														
	 3.5-17.60/20.0t	20.00	18.99	16.89	14.44	13.13	11.52	10.62	9.48	8.83	7.98	7.50														
35	 4.5-33.40/10t	1000	1000	1000	1000	1000	1000	1000	1000	9.50																
	 3.5-17.65/20.0t	20.00	19.10	16.95	14.60	13.20	11.60	10.65	9.50	8.80																
30	 4.5-30.00/10t	1000	1000	1000	1000	1000	1000	1000																		
	 3.5-17.65/20.0t	20.00	18.10	16.95	14.60	13.20	11.60	10.60																		

Counter-jib Ballast 平衡臂及平衡重组合表

 (m)	 (m)	 (kg)	 (4000kg)	 (3400kg)	 (1700kg)
75	19.25	24500	4	2	1
70	19.25	22800	4	2	0
65	19.25	22800	4	2	0
60	19.25	22800	4	2	0
55	19.25	21100	4	1	1
50	19.25	21100	4	1	1
45	19.25	18800	3	2	0
40	19.25	16500	2	2	1
35	19.25	15400	3	1	0
30	19.25	13100	2	1	1

Masts 塔身 L69 (2.0×2.0×3.0)

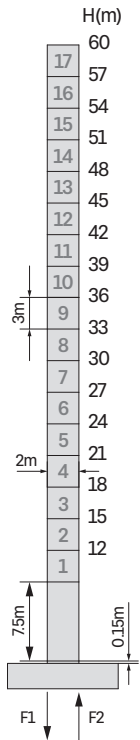

fixing outrigger
支腿固定式

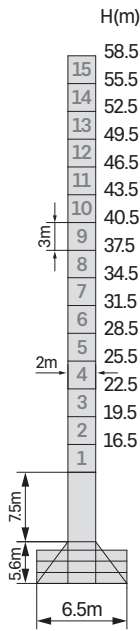

fixing underframe
底架固定式

Fixing outrigger 支腿固定式

F1	Reactions in service 工作状态反力	258.1t
	Reactions out of service 非工作状态反力	278.9t
F2	Reactions in service 工作状态反力	133.1t
	Reactions out of service 非工作状态反力	174.5t
Freestanding height, dead weight at the max. jib (without counter weight, lifting weight nor ballast) 独立高度, 最长起重臂时自重(不含平衡重、吊重、压重)		80.5t

Fixing underframe 底架固定式

F1	Reactions in service 工作状态反力	168.6t
	Reactions out of service 非工作状态反力	183.1t
Freestanding height, dead weight at the max. jib (without counter weight, lifting weight nor ballast) 独立高度, 最长起重臂时自重(不含平衡重、吊重、压重)		97.4t



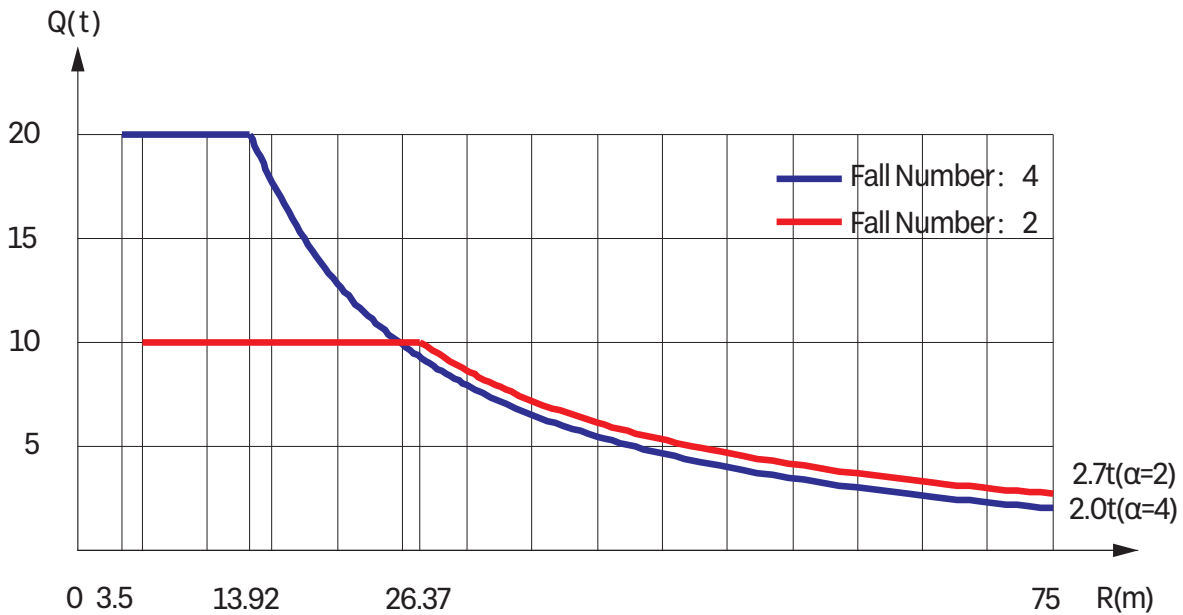



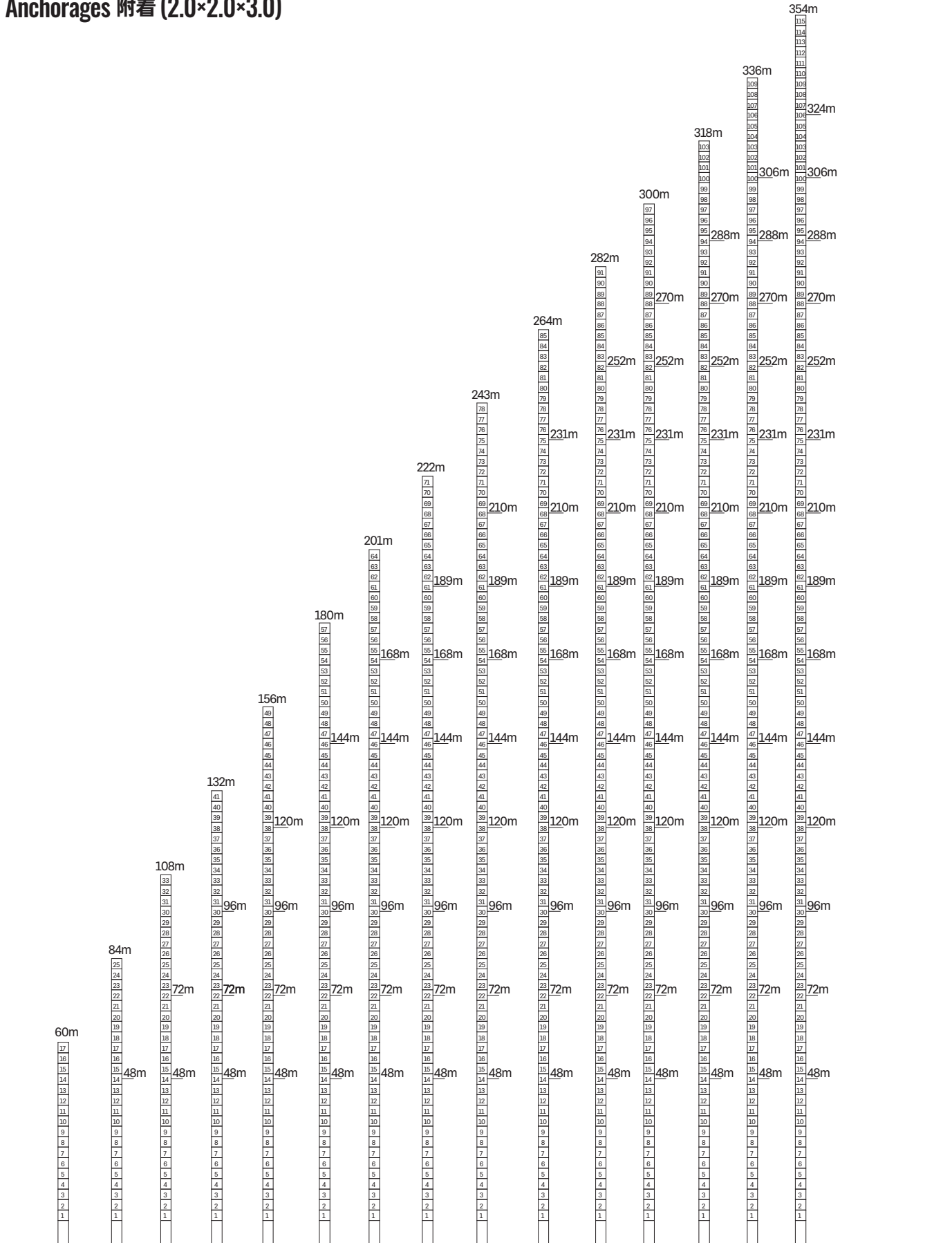



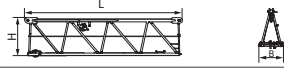
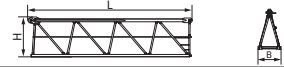
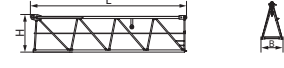

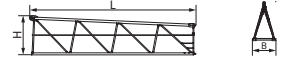

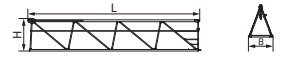
Curve of Lifting Capacity 起重性能曲线图

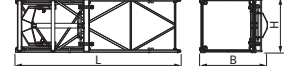

Anchorage 附着 (2.0×2.0×3.0)



Packing List 运输部件

NO. 序号	Description 名称	Sketch 形状	L(m) 长	B(m) 宽	H(m) 高	Weight per unit (t) 单件重量 (t)	Quantity 数量
1	Jib section I 臂架 I		10.39	1.64	2.51	4.03	1
2	Jib section II 臂架 II		10.07	1.46	2.48	2.93	1
3	Jib section III 臂架 III		10.05	1.46	2.12	2.27	1
4	Jib section IV 臂架 IV		5.05	1.46	2.44	1.00	1
5	Jib section V 臂架 V		10.25	1.46	2.14	1.59	1
6	Jib section VI 臂架 VI		5.01	1.46	1.94	0.73	1
7	Jib section VII 臂架 VII		10.02	1.46	1.92	1.05	1
8	Jib section VIII 臂架 VIII		5.01	1.46	1.88	0.42	1
9	Jib section IX 臂架 IX		10.05	1.46	1.87	0.65	1
10	End jib 臂端节		1.68	0.58	1.36	0.16	1
11	Hook 吊钩		1.85	0.25	1.86	0.80	1
12	Telescoping cage 爬升架		7.66	3.11	2.56	4.16	1
13	Slewing assembly 回转总成		5.66	2.84	3.36	7.14	1
14	Trolley assembly 小车总成		4.05	2.36	1.32	0.83	1
15	Square jib components+rod I 四方臂组 + 拉杆 I		6.89	1.65	2.49	3.05	1
16	Counter jib III +rod II 平衡臂 III + 拉杆 II		11.7	1.66	3.48	4.28	1
17	Chip standard mast 片式标准节		3.53	2.21	0.70	1.45	13
18	Chip standard mast 片式标准节		3.53	2.21	0.70	1.80	3
19	Hoisting Mechanism 起升机构		1.99	1.95	1.25	3.90	1

Packing List 运输部件

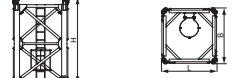
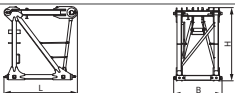
NO. 序号	Description 名称	Sketch 形状	L(m) 长	B(m) 宽	H(m) 高	Weight per unit (t) 单件重量 (t)	Quantity 数量
20	Transition mast assembly 过渡节总成		2.62	2.62	2.46	1.87	1
21	Conversion mast assembly 转换节总成		2.11	2.11	3.26	1.82	1
22	Tower head assembly 塔头总成		2.55	1.68	2.54	2.63	1



SANY GROUP CRANE BU

SANY Tower Crane Industrial Park, No.168 Jinzhou Avenue, Jinzhou Development Zone, Changsha City, Hunan Province, P.R. China Zip 410600
Consulting sanycrane@sanygroup.com (Crane BU) / crd@sany.com.cn (IHQ)
After-sales Service 0086-400 6098 318

Reminder:

Any change in the technical parameters and configuration due to product modification or upgrade may occur without prior notice. The machine in the picture may include additional equipment. This brochure is for reference only, and goods in kind shall prevail.

Copyright at SANY. No part of this brochure may be copied or used for any purpose without written approval from SANY.

© Edited in November 2022 v1.0

三一集团起重事业部

中国湖南长沙金洲开发区金洲大道168号三一塔式起重机产业园 邮编: 410600
咨询: sanycrane@sanygroup.com (起重事业部) / crd@sany.com.cn (国际总部)
海外售后服务: 0086-400 6098 318

温馨提示:

由于技术不断更新, 技术参数及配置如有更改, 恕不另行通知。图中机器可能包括附加设备, 本画册仅供参考, 以实物为准。
版权为三一所有, 未经三一书面许可, 本画册任何内容不得被复制用于任何目的。

© 2022 年 11 月版 v1.0

SANY CRANE   

www.sanyglobal.com

