

SCE8000A

Crawler Crane 800 Tons Lifting Capacity

Quality Changes the World



Max. lifting moment: 12000t·m
Max. Longest boom combination: 99m+96m
Longest boom for wind energy configuration: 165m+12m

The parameters, pictures and standard/optional equipment are only for reference in this brochure, the actual machine is based on the effective price list and contract.



Crawler Crane Series
SCE8000A

P03

Main Features

- Cab
- Upperworks
- Lower Structure
- Counterweight
- Operating Equipment
- Hydraulic System
- Working Weight
- Ground Pressure
- Gradeability
- Safety Device

P10

Technical Parameters

- Main Performance Parameters
- Outline Dimension
- Transport Dimension
- Assembly Plan

P28

Boom Combinations

- Combination
- ZHJFJDB Configuration
- ZHJFJ Configuration
- ZHJDB Configuration
- ZHDB Configuration
- ZLJDB Configuration
- H Configuration
- HDB Configuration
- HJ Configuration
- HJDB Configuration
- HJFJ Configuration
- LJ Configuration
- LJDB Configuration
- ZHEDB Configuration



SCE8000A
SANY CRAWLER CRANE
800 TONS LIFTING CAPACITY

QUALITY CHANGES THE WORLD

Features

- Page 04 Cab
- Page 05 Superstructure
- Page 06 Lower Structure
- Page 06 Counterweight
- Page 07 Working Element
- Page 07 Hydraulic System
- Page 07 Working Weight
- Page 07 Ground Pressure
- Page 07 Gradeability
- Page 08 Safety Device



Cab



Appearance

- The industrial modeling of the cab is designed by Porsche. It has a smooth, elegant and novel appearance, which is a significant breakthrough when compared with traditional engineering machinery and has excellent brand identification. The cab has a sliding door structure, which is suitable for the crawler crane and convenient for the operator. It is adopted with fully-sealed steel frame structure with a large area of high strength toughened glass installed on the front, side and top, transmitting more light. The interior space of the cab is spacious and bright, with a broader sight view.

Comfort

- It is adopted with shock absorption, noise reduction, suspended, multi-mode and multi-stage adjustable seat, thus providing the operator with the most comfortable driving experience. The famous USA RedDot air conditioner is adopted, ensuring more reasonable air outlet and efficient cooling. It takes no more than 20 min to cool the cab from 55°C to 27.5°C. The left and right armrest boxes and auxiliary control boxes are equipped with control handles, control buttons, ignition locks and other elements. The seats, control handles and control buttons are arranged according to ergonomic design, fully considering the driver's operation demands and habits. The control box can be adjusted to the most suitable position with the seat to ensure more comfortable operation. The cab can tilt up to 15° according to the work demands, and can also rotate to the front part of the rotating bed for the convenience of transport.

Lower structure



Carbody

- The hydraulic cylinder driving power pin is connected with the crawler frame for easy assembly and disassembly. The high-strength steel welded frame structure is adopted. Larger carbody design significantly improves the stability of the overall crane. The carbody counterweight is 80t (40t in the front and rear respectively), and it can realize self-assembly.

Crawler Assembly

- Crawler frames: each crawler frame is equipped with independent traveling driving devices. The planetary gear tapered is driven by the hydraulic traveling motor, and independent traveling is realized through the transmission of the driving gear. The driving system has two speed positions, namely high speed and low speed: The low speed can provide sufficient traction force to realize 100% travel with load; the high speed can provide higher speed to improve the transit efficiency. The traveling drive can also realize stepless speed change.
- Track shoe: It is made of materials with high strength and high wear resistance through advanced casting process. After being installed on the equipment, its tension can be adjusted through the hydraulic cylinder, and the gasket position can be adjusted to achieve the ideal tension.

One-key Leveling of Outriggers

- With the machine gravity calculated in real time, the outrigger balance is detected by the cylinder pressure sensor, the outriggers can be adjusted to level state by one key to reduce assembly time and improve efficiency.



Superstructure

Engine

- Cummins (Euro Tier V).
- Rated power: 447 kW.
- Rated speed: 1800 rpm.
- Maximum output torque: 2542 N·m.
- Speed at the maximum output torque: 1400 rpm.

Load hoist winch mechanism

- The planetary gear box driven by hydraulic motor of variable displacement is used to control the main load hoist I and main load hoist II to lift and lower the load. It provides good inching performance, and also ensures quick powered lifting of main load hoist winches.
- Only one hoist winch is needed for load below 400t, while for load above 400t, both load hoist winches are required. The main hoist winch I and main hoist winch II have synchronization function.
- The maximum number of parts of line is 60. The multilayer winding of rope-folding drum ensures no rope disorder. The gear box is featured in low noise, high efficiency, long service life and easy access to oil change.

Main load hoist winch W1-1 (main load hoist winch 1) W1-2 (main load hoist winch 2)	Drum diameter	726mm
	Speed of rope in the outermost working layer	0-164m/min
	Diameter of wire rope	28mm
	Rope length	1250m
	Rated line pull	17.2t
Auxiliary load hoist winch W2	Drum diameter	574mm
	Speed of rope in the outermost working layer	124m/min
	Diameter of wire rope	28mm
	Rope length	600m
	Rated line pull	17.2t

Boom hoist winch mechanism

- Components: Boom luffing mechanism, jib luffing mechanism, superlift luffing mechanism.
- All luffing winches adopt fold-line drums, which are driven by hydraulic motor through the planetary gear box and can realize a number of compound actions and good inching performance.

Boom luffing mechanism W3	Drum diameter	574mm
	Speed of rope in the outermost working layer	63*2m/min
	Diameter of wire rope	28mm
	Rope length	800m
Jib luffing mechanism W4	Drum diameter	574mm
	Speed of rope in the outermost working layer	0~148m/min
	Diameter of wire rope	28mm
	Rope length	1050m
Superlift luffing mechanism W5	Drum diameter	574mm
	Speed of rope in the outermost working layer	0~164m/min
	Diameter of wire rope	28mm
	Rope length	1360m

Slewing mechanism

- The slewing hydraulic system adopts double motor to drive the spur gear through the planetary gear box, which can realize 360° rotation, slewing speed of 0~0.8 rpm, stepless speed regulation, no backlash at starting or stopping, stable operation and free slipping function at neutral position. Slewing ring: It is adopted with three-row roller type slewing bearing with external gears. The main unit can be separated from the lower structure through the adaptor ring.

Working implement



- The operating equipment is made of high-strength steel tubes and high-strength steel plates, and the rolled welded pulleys are adopted on the boom head and hook.

Boom

- The boom is a spatial lattice structure of welded tubes with equal section areas of inserts and tapered sections for two ends. The boom top and root are strengthened with steel plates, which is easier for load transfer.
- The length of the boom is 99m.
- Compositions: boom base 10.5m, 1 transition section of 12 m, 1 connecting tip of 1.5m, 1 insert of 3m, 2 inserts of 6m, and 5 inserts of 12 m.
- The extension jib is installed on the boom top.

Fixed jib

- The space truss structure with variable section and steel pipe welding of fixed jib are more conducive to load transfer.
- The length of the fixed jib is 12m.
- Compositions: jib base 6m×1, jib top 6m×1.

Luffing jib

- The luffing jib is a spatial lattice structure of welded tubes with equal section areas of inserts and tapered sections for two ends. The jib top and root are strengthened with steel plates, which is easier for load transfer.
- The length of the luffing jib is 96m.
- Compositions: jib base 10.5m×1, boom insert 12m×1(H8E), tapered section 6m×1, insert 6m×2, insert 12m×4, jib top 7.5m.
- The extension jib is installed on the jib top.

Power boom

- The power boom is a spatial lattice structure of welded tubes with equal section areas of inserts and tapered sections for two ends. The boom top and root are strengthened with steel plates, which is easier for load transfer.
- The length of the power boom is 108m.
- Compositions: transition boom top:12m×1, transition boom down:12m×1, boom insert 12m×7.

Eagle tip

- The space truss structure with variable section and steel pipe welding of eagle tip are more conducive to load transfer.
- The length of the eagle tip is 7m.
- Compositions: Boom top 4.5m, eagle tip 7m.

Superlift device

- The superlift mast is a spatial lattice structure of welded tubes with equal section areas of inserts and tapered sections for two ends. The mast base and top are strengthened with steel plates, which is easier for load transfer.
- The length of the superlift mast is 42m.
- Compositions: superlift base 12m×1, insert 6m×1, insert 12m×1, top 12m×1.

Hook

- There are 5 types of hook available. The specific parameters are as follows:

Hook	Maximum lifting capacity	Quantity	Number of pulleys	Basic weight	Recommended weight	CW block number of recommended weight
800t hook	800t	1	2×15	18.7t	23.2t	6
500t hook	500t	1	2×9	11.3t	17.3t	8
250t hook	250t	1	2×5	6.2t	12.2t	8
160t hook (single pulley block)	160t	1	5	2.5t	5.5t	4
18t ball hook	18t	1	0	1.0t	/	/
Hook CW block	/	12	/	0.75t	/	/

Note: Recommended weight is officially recommended for use.
Recommended weight=Hook basic weight + hook CW weight.



Additional device

- Side outriggers.
- Lower structure jack cylinders.
- Crawler self-assembly cylinder (on the boom hoist mast).
- Portable hydraulic power pack.
- Quick connector ring (connecting the superstructure/lower structure).



Counterweight

- The counterweight includes the carbody counterweight, rear counterweight, superlift counterweight, and the specific parameters are as follows:

Name	Quantity	Length(m)	Width(m)	Height(m)	Unit weight(t)
Carbody counterweight	4	2.40	2.85	0.484	10
Carbody counterweight tray	2	2.97	5.43	1.06	20
Rear counterweight	20	2.40	2.85	0.484	10
Rear counterweight tray	2	3.00	2.66	2.40	15
Superlift counterweight	36	2.40	2.85	0.484	10
Superlift counterweight tray	1	9.25	2.50	1.80	32
Rear counterweight additional tray	1	3.64	2.95	1.74	6.5



Hydraulic system

- Hydraulic system includes load hoist hydraulic system, traveling hydraulic system, slewing hydraulic system, boom hoist hydraulic system, servo hydraulic system, back-stop hydraulic system, cooling system, auxiliary hydraulic system. The main hydraulic components are original parts imported.
- Characteristics: The load hoisting, traveling, boom hoist and slewing hydraulic systems are of closed loop type, featuring energy saving, high efficiency, quick response, low heat radiation and long service life.
- The servo system adopts electrical proportional control components to facilitate the accurate and intelligent control.
- The back-stop hydraulic system adopts balance valve of external control and unloading, and it is mounted on the cylinder to make sure it is safe and reliable.
- The cooling system is characterized by higher power and quicker cooling.



Working weight

- The working weight is about 610t, including superstructure, lower structure, main unit counterweight, central counterweight, 24m base boom and 800t hook.



Ground pressure

- The average ground bearing pressure of the crane with base boom is 0.2 MPa.



Gradeability

- The gradeability of the crane with base boom is 15%.

Safety devices



Load Moment Indicator

- The proprietary load moment limiter independently -developed by Sany is adopted, which forms a network with other controllers through CAN bus line, so as to realize safe and reliable control. The load moment limiter can automatically detect the hoisting weight of the crane and the angle of the boom, and display the rated load capacity, actual load, working radius, and the allowable height of the hook.
- The load moment limiter system consists of a large-screen color display, a host computer, angle sensors, tension sensors, pressure sensors and other components.

Over-hoist Protection of the Main and Auxiliary Hooks

- It is used to prevent the over-hoist of the hook. When the lifting hook is raised to a certain height, the limit switch will start working, and hook will be automatically cut off from moving up by the control system. Meanwhile, the display and the buzzer will give alarms. At this moment, only hook lowering is allowed to prevent over-hoist action.

Over-release Protection Device of the Main and Auxiliary Hook

- It is used to prevent the wire rope over-release. When the wire rope is released to the last three wraps, the limit switch will start working, and the releasing of rope will be automatically stopped by the control system. Meanwhile, the display and the buzzer will give alarms. At this moment, only rope retraction is allowed to prevent over release action.

Boom Angle Limit

- When the elevation angle of the boom exceeds 85° or jib angle exceeds 75° , corresponding limit switch will be triggered, and the control system will automatically cut off the boom hoisting. Meanwhile, the display and the buzzer will give alarm. At this moment, boom/jib luffing winch won't hoist but it can still lower down.
- When the boom down angle is less than 30° or jib down angle is less than 15° , the control system will automatically cut off the boom/jib from further lowering. Meanwhile, the display and the buzzer will give alarms. At this moment, boom/jib luffing winch won't be able to lower. This protection is automatically controlled by Load Moment Limiter.

Back-stop Device

- The boom and the superlift mast are respectively equipped with a pair of back-stop cylinders. The high pressure of the cylinder shall be overcome when the boom tilts backwards, and high pressure oil will be supplemented automatically when the boom swings forwards to increase the tension and prevent the boom vibration and shaking back.
- The jib rear mast is equipped with a pair of back-stop cylinders, while the jib front mast is equipped with a pair of pneumatic cylinders to prevent the mast from the backward inclination and tension of the jib luffing wire rope.

Brake of Hoisting Mechanism

- All hoisting brakes are spring loaded normally closed disc brakes, which are featured with large braking force, maintenance-free, safe and reliable use, and long service life.

Closed Circuit Monitoring System

- It can be used to monitor the winding conditions of wire ropes of each hoisting mechanism, the conditions of superlift weight, and conditions around the equipment.
- Video recorder can store video as long as 76 hours.
- Machine operation can be recorded.

Failure Auto-Diagnosis System

- Failure code can help troubleshooting easily.



Safety devices

Black Box

- It is able to record the operation data and machine movement, and analyze the remaining running conditions and service life of machine based on the actual performance.

Pharos

- It is mounted on the top of the boom/jib and alerts in air during night.

Anemometer

- It is mounted on the top of the boom/jib to monitor the wind speed in real time and display relative data on the monitor.

Electronic Level Indicator

- It displays the tilting angle of the crane on the monitor in real time and protects the safe operation of the crane.

Lightning Protection Device

- It includes the lightning protection device and the surge protection device, which can effectively protect the electric system elements and workers from lightning.

Hook Latch

- The lifting hook is installed with a baffle plate to prevent wire rope from falling off.

Swing and Traveling Alarm

- During swing and traveling, the alarm horn will be blown per certain frequency to alert the personnel around the crane. The horn can be shut off through the display.

Function Lock

- The operation will be locked by pulling up the function locking lever on the right side of the seat inside the driver's cab or when the operator left the seat, after which no operating handles will be working so that improper operation caused by the body collision when getting on and off the crane can be avoided.

Regulation of Engine Power Ultimate Load and Stalling Protection

- The controller can monitor the engine power so as to prevent stalling.

Remote Monitoring System

- It monitors and analyzes the operation data so as to realize remote diagnosis of faults and timely solution.

Proactive Safety Control Technology

- Swing speed can be automatically reduced based on boom length to make it safer.
- Flexible safety protection reduces the speed when the mechanism approaches to the safety limit position, which ensures reliability.
- Real-time monitor of hydraulic oil temperature allows limits on the action speed based on oil temperature, which protect the hydraulic components effectively.
- The protection can be set on man-machine interface as customer needs.



SCE8000A
SANY CRAWLER CRANE
800 TONS LIFTING CAPACITY

QUALITY CHANGES THE WORLD

Technical Parameters

- Page 11 Main Performance Parameters
- Page 12 Outline Dimension
- Page 14 Transport Dimension
- Page 23 Assembly Plan

> 10

Main performance parameters

Major Performance & Specifications of SCE8000A		
Performance indexes	Unit	Parameter
Maximum rated lifting capacity	t	800 (6m operating radius)
Maximum rated lifting capacity (with superlift)	t	800 (12m operating radius)
Maximum rated lifting moment	t·m	4956
Maximum rated lifting moment (with superlift)	t·m	12000
Boom length	m	24~99
Boom length (with superlift)	m	42~111
Mixed boom length	m	84~123
Mixed boom length (with superlift)	m	90~147
Mixed boom length (with superlift and power boom)	m	102~165
Luffing jib length	m	24~96
Luffing jib length (with superlift)	m	24~96
Length of short fixed jib	m	12
Longest boom combination (LJDB working condition)	m	99+96
Longest boom for wind energy configuration (without superlift)	m	120+12
Longest boom for wind energy configuration (with superlift)	m	165+12
Longest boom for eagle tip configuration (with superlift)	m	171+7
Boom luffing angle	°	30~85
Jib luffing angle	°	15~75
Maximum rope speed of single rope of main load hoist winch (outermost working layer)	m/min	164
Maximum rope speed of single rope of aux. load hoist winch (outermost working layer)	m/min	124
Maximum rope speed of single rope of boom luffing mechanism (outermost working layer)	m/min	63×2
Maximum rope speed of single rope of jib luffing mechanism (outermost working layer)	m/min	148
Maximum rope speed of single rope of superlift luffing mechanism (outermost working layer)	m/min	164
Slewing speed (no load)	r/min	0.8
Travelling speed	km/h	0~0.6
Gradeability (with basic boom, cab facing backward)	%	30
Rated output power of the engine	kW/r/min	447/1800
Machine weight (basic boom, 230t machine rear counterweight, 80t carbody counterweight, with 800t hook)	t	610
Average ground bearing pressure of the crawler (base boom, 230t machine counterweight, 80t carbody counterweight, 800t hook)	MPa	0.2
Machine counterweight	t	230
Superlift counterweight (including tray)	t	390
Carbody counterweight (including tray)	t	80
Maximum transportat dimensions of single piece (L×W×H)	mm	14600×3400×2640
Maximum transport weight of single piece	t	52
Transport weight of rotating bed (with quick connector ring)	t	48

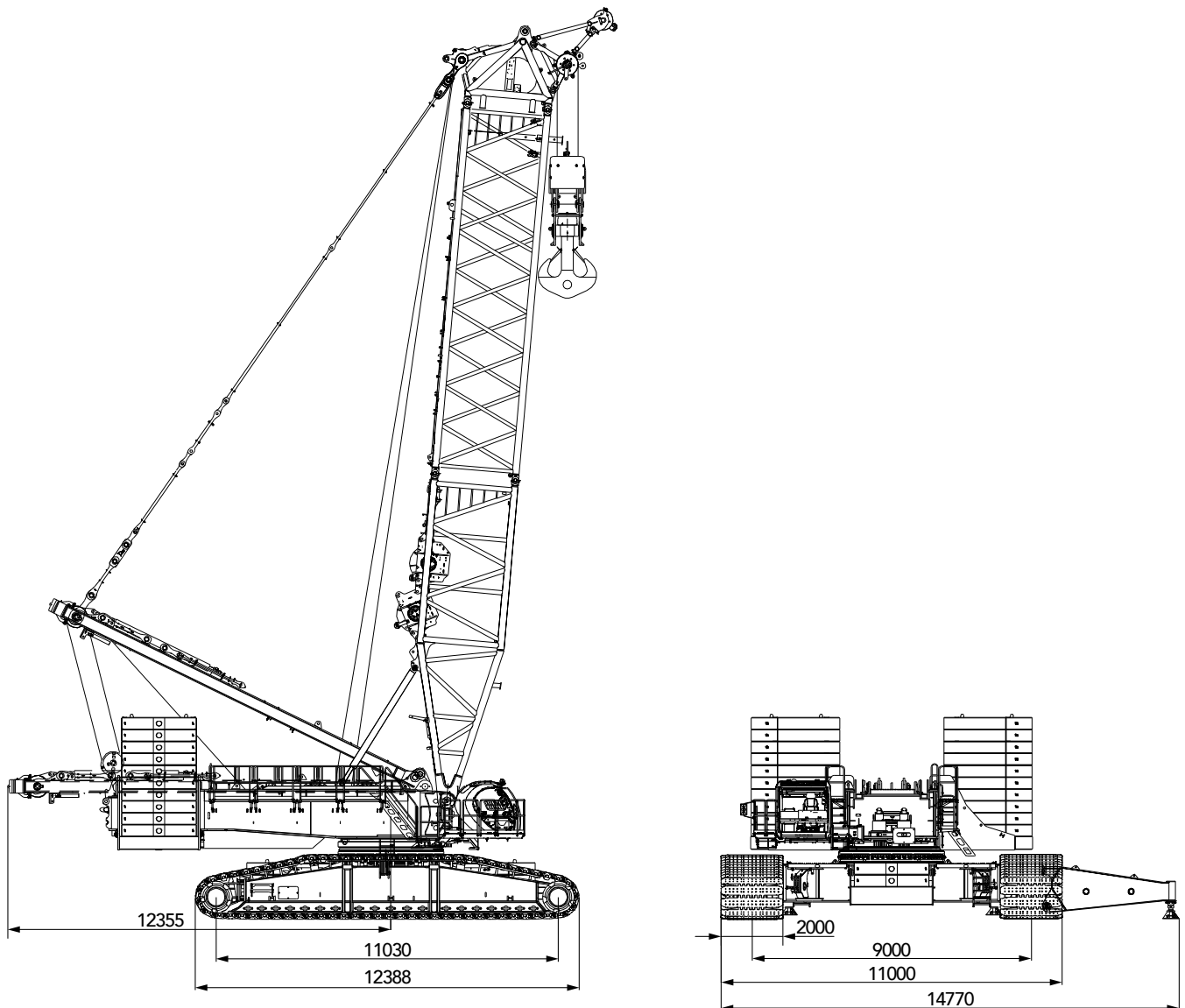
Outline dimension

Unit: mm

Outline dimension

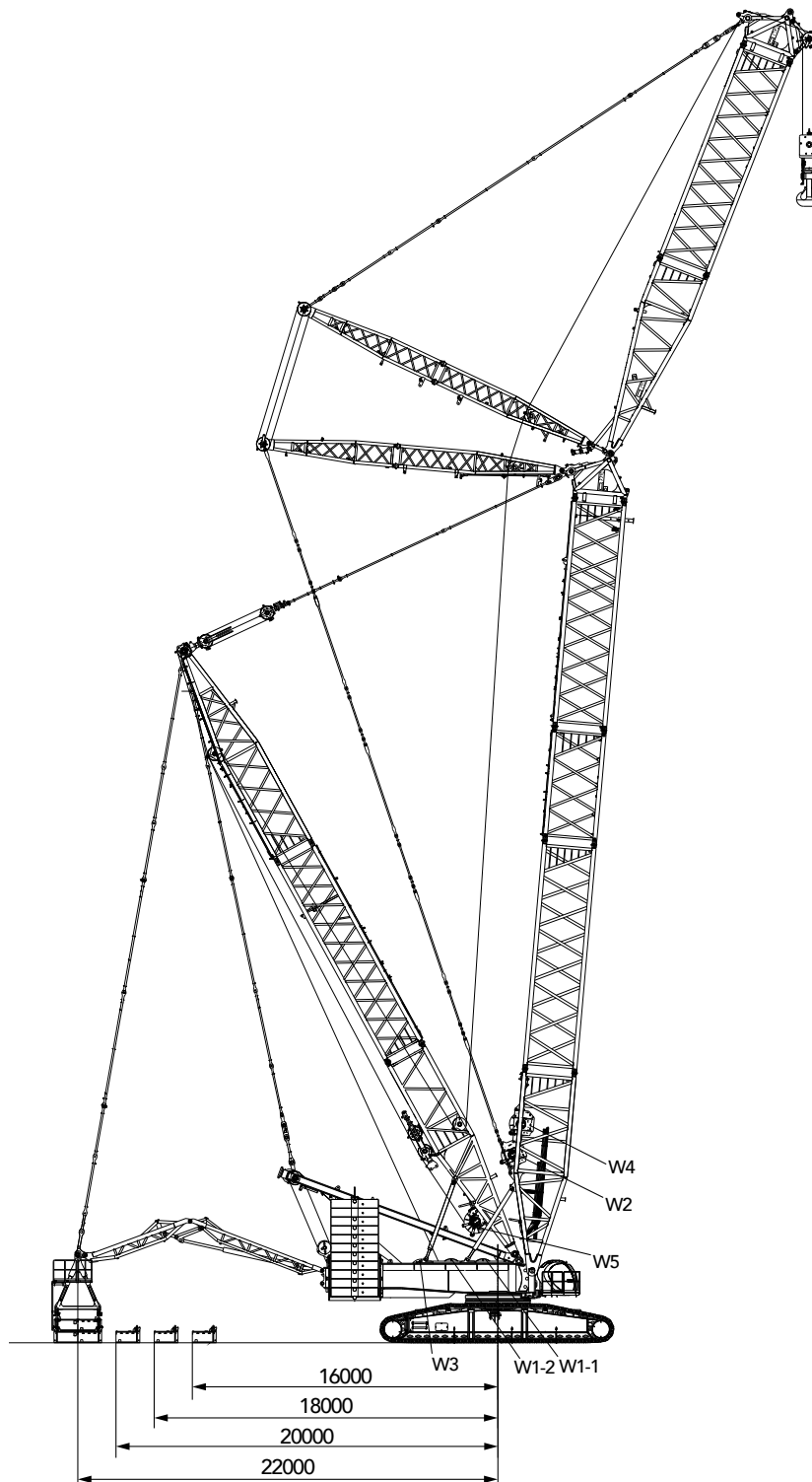

Transport dimension

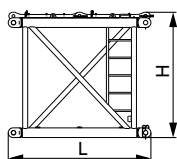
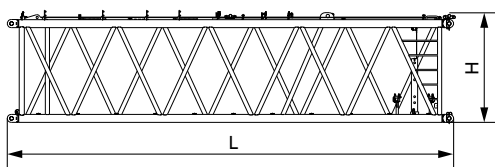
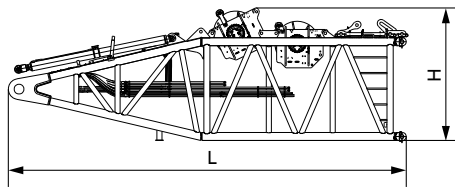
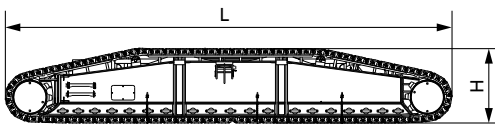
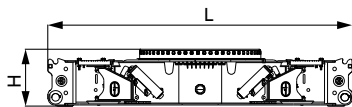
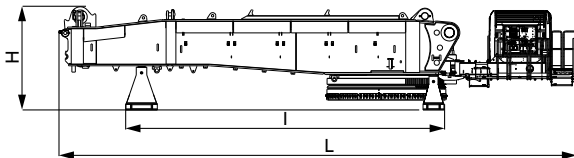

Basic machine (with quick connector ring) ×1

Length (L)	14.60m
Width (W)	3.40m
Height (H)	2.96m
Length (l)	9.10m
Weight	48t

Carbody (with quick connector ring) ×1

Length (L)	8.36m
Width (W)	3.40m
Height (H)	1.56m
Weight	32t

Crawler assembly ×2

Length (L)	12.37m
Width (W)	2.00m
Height (H)	2.07m
Weight	52t

Boom base (H2) (with aux. hoist and jib luffing winches) ×1

Length (L)	10.90m
Width (W)	3.00m
Height (H)	3.63m
Weight	31.5t

Note: aux. hoist winch 5.5t, jib luffing winch 8.3t

12m transition section (H4) ×1

Length (L)	12.24m
Width (W)	2.99m
Height (H)	3.02m
Weight	9.1t

3m boom insert ×1

Length (L)	3.24m
Width (W)	2.99m
Height (H)	3.02m
Weight	2.9t

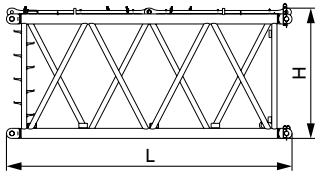
Transport dimension

6m boom insert (H6)	×2
Length (L)	6.24m
Width (W)	2.99m
Height (H)	3.02m
Weight	5.1t

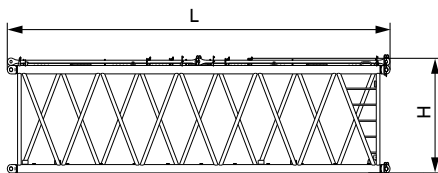

12m boom insert B (H8B)	×2
Length (L)	12.24m
Width (W)	2.99m
Height (H)	3.02m
Weight	9.3t

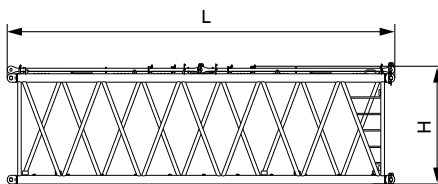

12m boom insert C (H8C)	×2
Length (L)	12.24m
Width (W)	2.99m
Height (H)	3.02m
Weight	8.3t

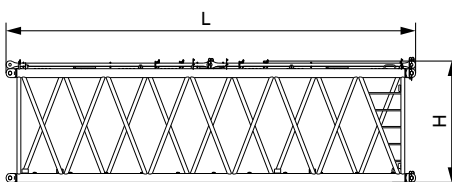

12m boom insert D (H8D)	×1
Length (L)	12.24m
Width (W)	2.99m
Height (H)	3.02m
Weight	7.7t

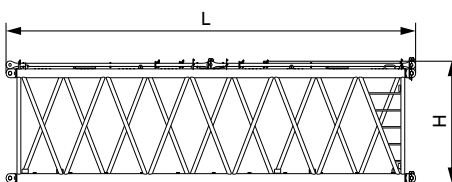

12m boom insert E (H8E)	×1
Length (L)	12.24m
Width (W)	2.99m
Height (H)	3.02m
Weight	6.9t

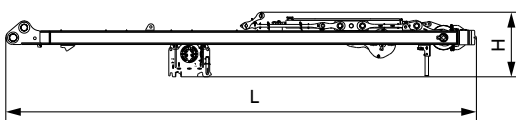

Boom hoist mast	×1
Length (L)	13.59m
Width (W)	2.41m
Height (H)	1.73m
Weight (including boom hoist winch)	23t

Transport dimension

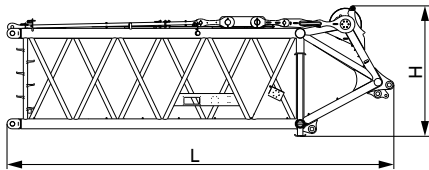

Luffing jib top (LJ1)

×1

Length (L)	8.55m
Width (W)	2.57m
Height (H)	3.02m
Weight	6.5t

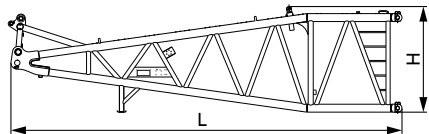

Luffing jib base (LJ2)

×1

Length (L)	10.80m
Width (W)	2.99m
Height (H)	3.01m
Weight	9.2t

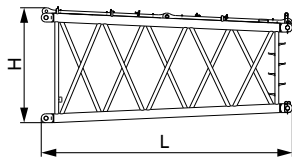

6m jib tapered insert (LJ4)

×1

Length (L)	6.24m
Width (W)	2.99m
Height (H)	3.01m
Weight	3.4t

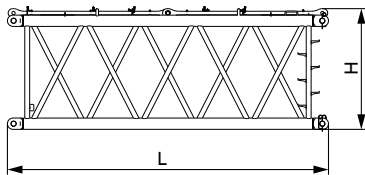

6m luffing jib insert A (LJ6)

×2

Length (L)	6.24m
Width (W)	2.57m
Height (H)	2.46m
Weight	3.23t

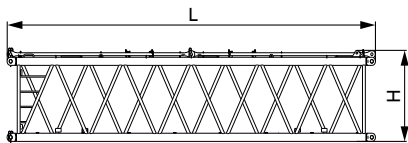

12m luffing jib insert A (LJ8A)

×1

Length (L)	12.24m
Width (W)	2.57m
Height (H)	2.46m
Weight	5.5t

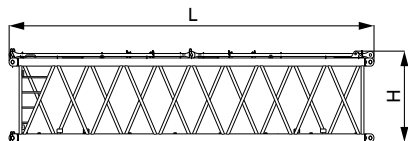

12m luffing jib insert B (LJ8B)

×3

Length (L)	12.24m
Width (W)	2.57m
Height (H)	2.46m
Weight	5.2t

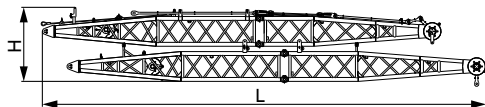
Transport dimension**Luffing jib front and back struts** ×1

Length (L)	18.00m
Width (W)	2.62m
Height (H)	3.00m
Weight	17t

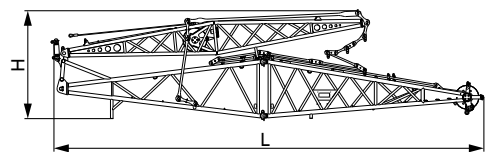
**Fixed jib assembly** ×1

Length (L)	14.60m
Width (W)	2.51m
Height (H)	3.28m
Weight	7.2t

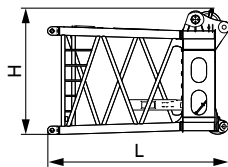
**Eagle tip assembly** ×1

Length (L)	4.77m
Width (W)	3.00m
Height (H)	3.30m
Weight	4.9t

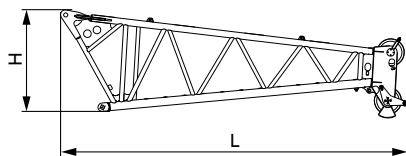
**Eagle tip assembly** ×1

Length (L)	9.18m
Width (W)	1.85m
Height (H)	2.60m
Weight	3.7t

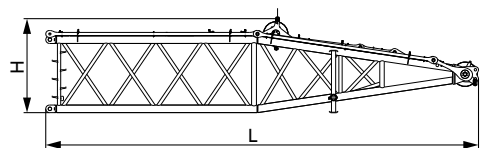
**Superlift mast top (D1)** ×1

Length (L)	12.52m
Width (W)	2.99m
Height (H)	2.78m
Weight	15.1t

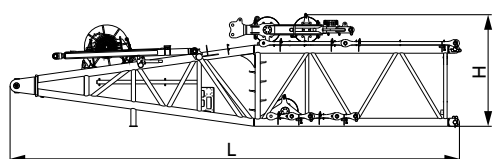
**Superlift mast base (D2)** ×1

Length (L)	12.30m
Width (W)	2.99m
Height (H)	3.11m
Weight (with winch)	29.7t

Transport dimension

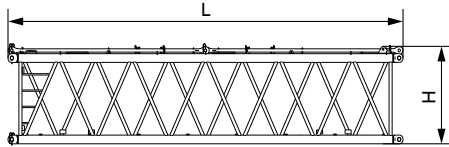

12m superlift mast insert (D6)

×1

Length (L)	12.24m
Width (W)	2.90m
Height (H)	2.43m
Weight	8.3t

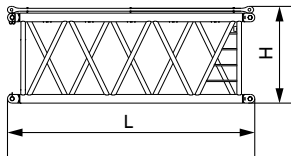

6m superlift mast insert (D4)

×1

Length (L)	6.24m
Width (W)	2.90m
Height (H)	2.43m
Weight	4.7t

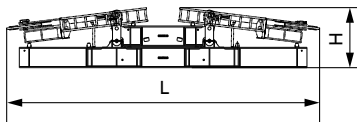

Superlift counterweight tray

×1

Length (L)	9.25m
Width (W)	2.64m
Height (H)	1.78m
Weight	32t

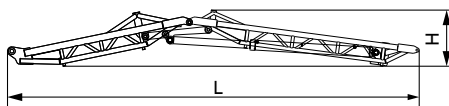

Superlift counterweight strut

×1

Length (L)	13.90m
Width (W)	3.00m
Height (H)	2.93m
Weight	9.28t

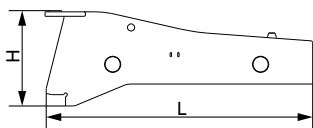

Carbody counterweight tray

×2

Length (L)	3.23m
Width (W)	2.80m
Height (H)	1.20m
Weight	20.0t

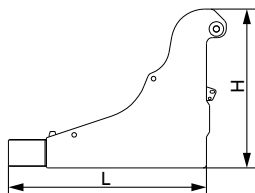

Rear counterweight tray

×2

Length (L)	3.30m
Width (W)	2.80m
Height (H)	2.40m
Weight	15.0t

Transport dimension

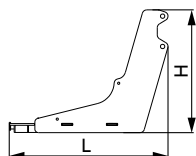

Additional tray of rear counterweight ×1

Length (L)	3.54m
Width (W)	2.93m
Height (H)	2.74m
Weight	6.5t

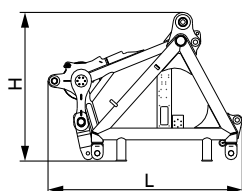

Connecting tip (H9A) ×1

Length (L)	3.73m
Width (W)	2.99m
Height (H)	2.77m
Weight	6.3t

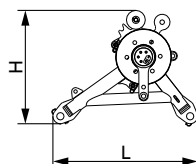

Pulley block (800t) ×2

Length (L)	1.84m
Width (W)	1.67m
Height (H)	1.44m
Weight	2.5t

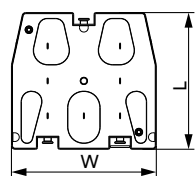

10t counterweight ×60

Length (L)	2.85m
Width (W)	2.40m
Height (H)	0.45m
Weight	10.0t

Remarks: 4 blocks for carbody counterweight, 20 blocks for machine rear counterweight, 36 blocks for superlift counterweight.

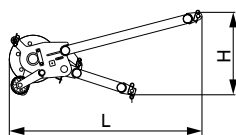

Extension jib (16t) ×1

Length (L)	2.60m
Width (W)	1.07m
Height (H)	1.11m
Weight	0.6t

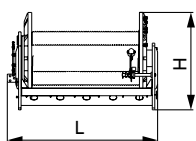

Main load hoist winch ×2

Length (L)	1.89m
Width (W)	1.23m
Height (H)	1.28m
Weight	8.3t

Transport dimension

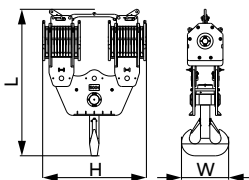
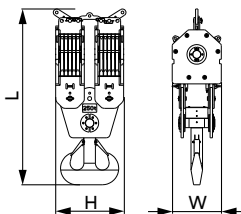
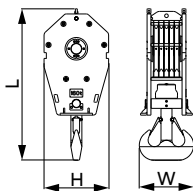
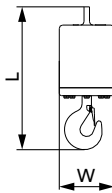
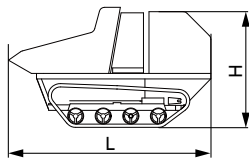
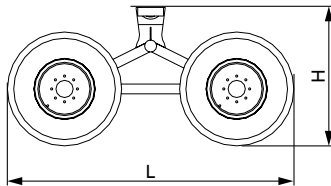

Trolley ×1

Length (L)	3.10m
Width (W)	2.13m
Height (H)	1.46m
Weight	1.9t

Portable power pack ×1

Length (L)	1.74m
Width (W)	1.00m
Height (H)	1.00m
Weight	0.5t

18t ball hook ×1

Length (L)	1.33m
Width (W)	0.50m
Height (H)	0.50m
Weight	1.0t

160t hook ×1

Length (L)	2.35m
Width (W)	0.84m
Height (H)	1.00m
Weight	2.5t

250t hook ×1

Length (L)	3.59m
Width (W)	1.00m
Height (H)	1.38m
Weight	6.2t

500t hook ×1

Length (L)	4.13m
Width (W)	1.33m
Height (H)	2.91m
Weight	11.3t

Transport dimension

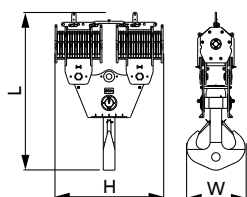

800t hook	×1
Length (L)	5.10m
Width (W)	1.89m
Height (H)	3.48m
Weight	18.7t

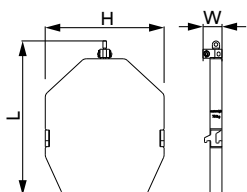

Hook counterweight	×12
Length (L)	1.30m
Width (W)	0.16m
Height (H)	1.00m
Weight	0.789t

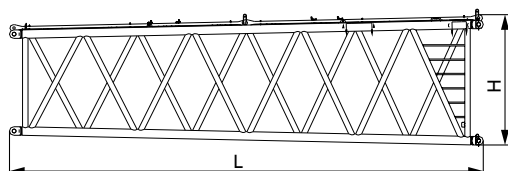

12m lower transition section (ZH4A)	×1
Length (L)	12.24m
Width (W)	3.50m
Height (H)	3.02m
Weight	11.1t

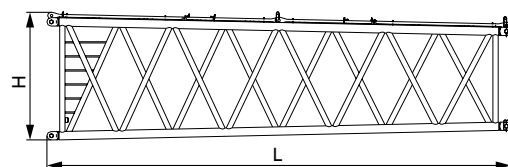

12m upper transition section (ZH4B)	×1
Length (L)	12.24m
Width (W)	3.50m
Height (H)	3.02m
Weight	9.1t

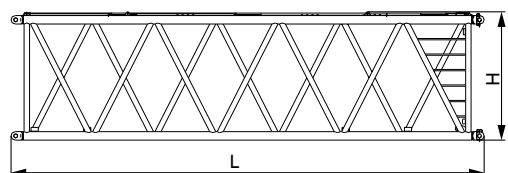

12m power boom insert A (ZH8A)	×1
Length (L)	12.24m
Width (W)	3.50m
Height (H)	3.02m
Weight	10.0t

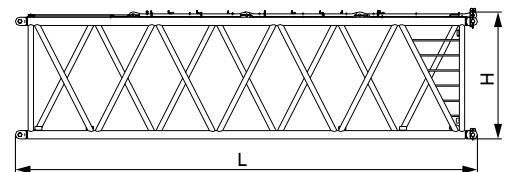

12m power boom insert B (ZH8B)	×1
Length (L)	12.24m
Width (W)	3.50m
Height (H)	3.02m
Weight	10.6t

Transport dimension

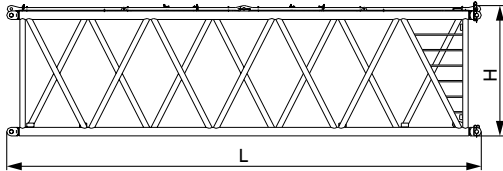

12m power boom insert C (ZH8C) ×2

Length (L)	12.24m
Width (W)	3.50m
Height (H)	3.02m
Weight	10.0t

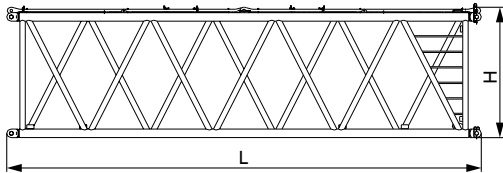

12m power boom insert D (ZH8D) ×3

Length (L)	12.24m
Width (W)	3.50m
Height (H)	3.02m
Weight	9.1t

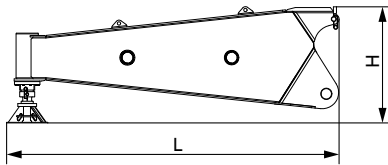

Side erection outrigger ×2

Length (L)	4.35m
Width (W)	1.25m
Height (H)	1.52m
Weight	2.6t

Note:

- 1.The transport dimensions of each part are schematic, may not be proportional to the real parts. The dimensions are designed value without package considered.
- 2.The weight is designed value that the actual manufactured part may deviate slightly.
- 3.The dimensions and weight of each part may upgrade along the time. The final values are subject to the new product.

Assembly plan

1) Boom assembly

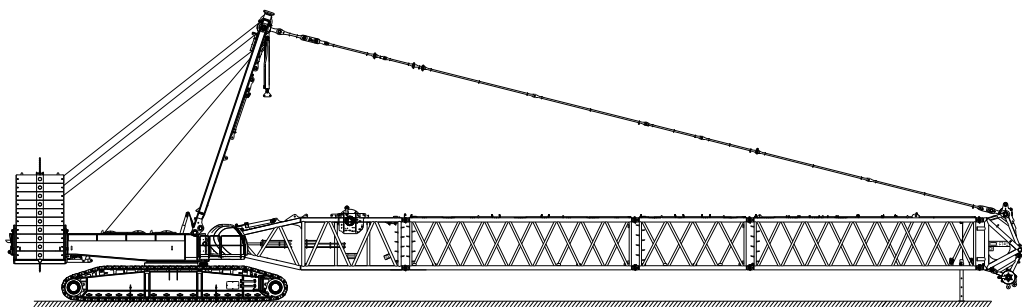
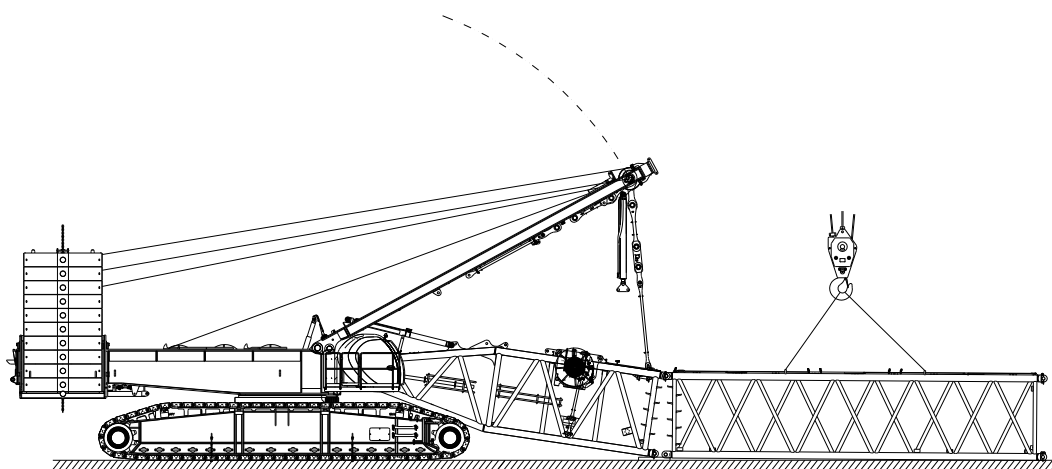

Assembly plan

2) Superlift mast assembly

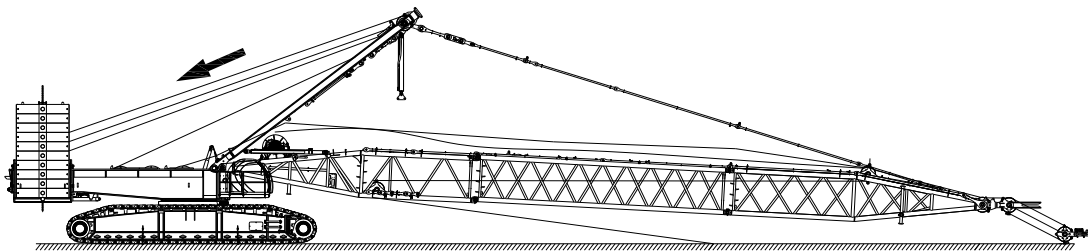
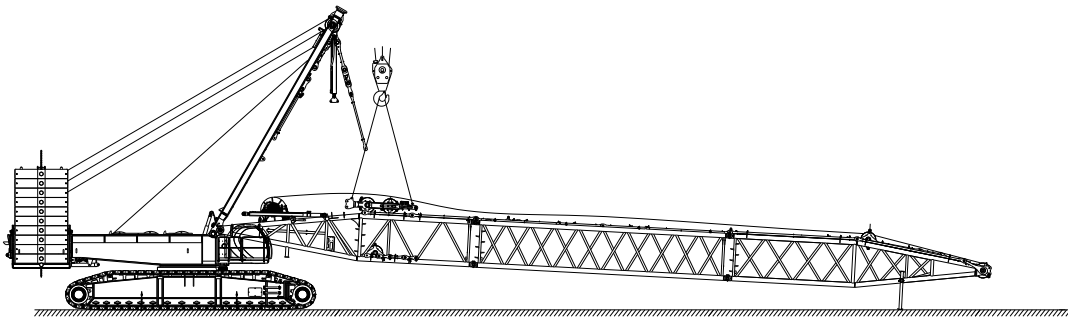
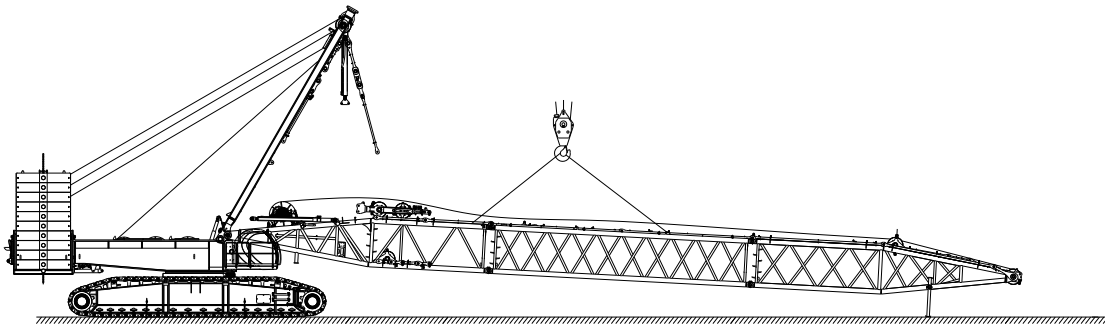

Assembly plan

3) Fixed jib assembly

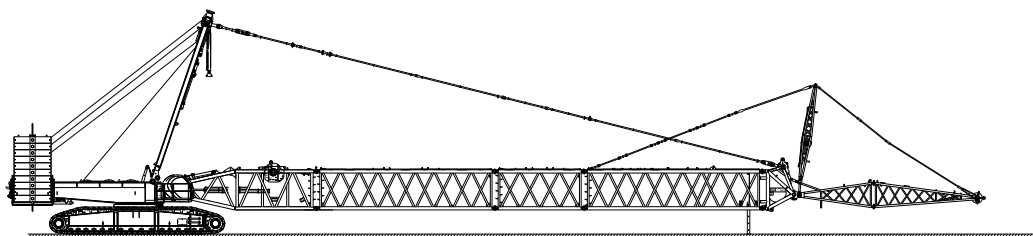
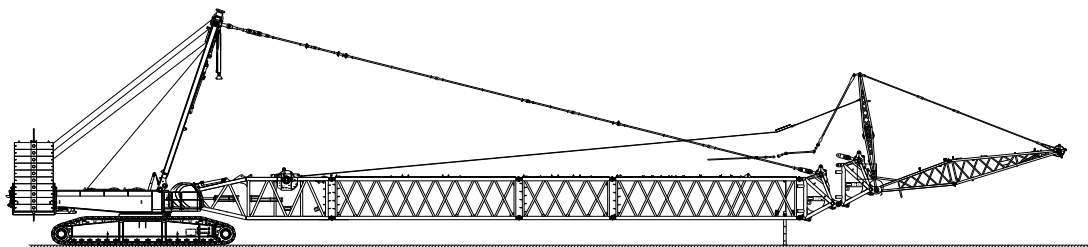
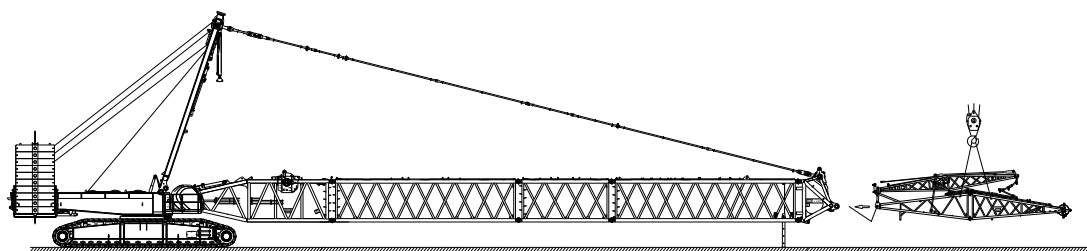

Assembly plan

4) Luffing jib assembly

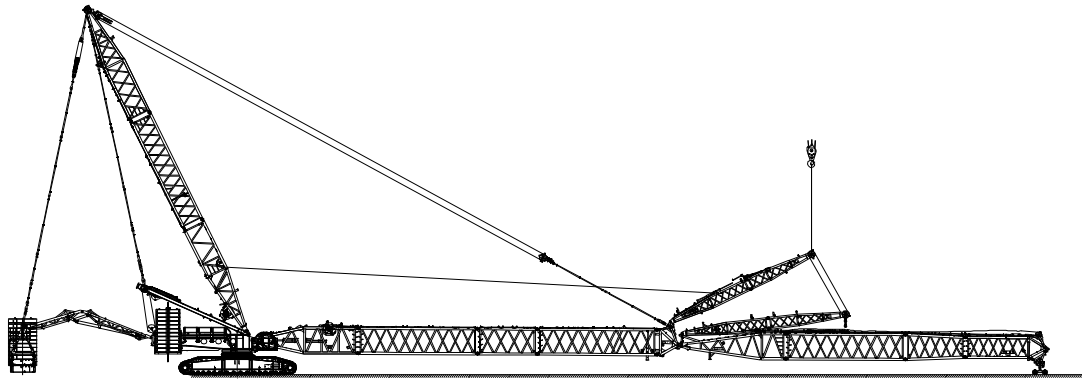
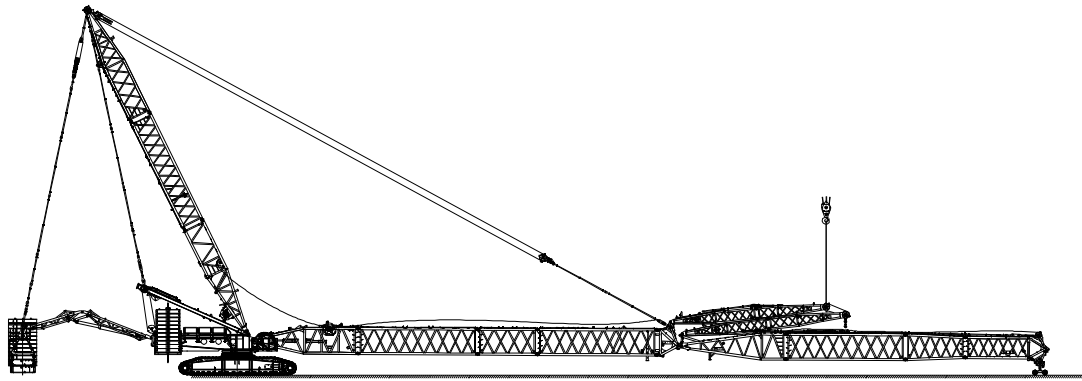

Assembly plan

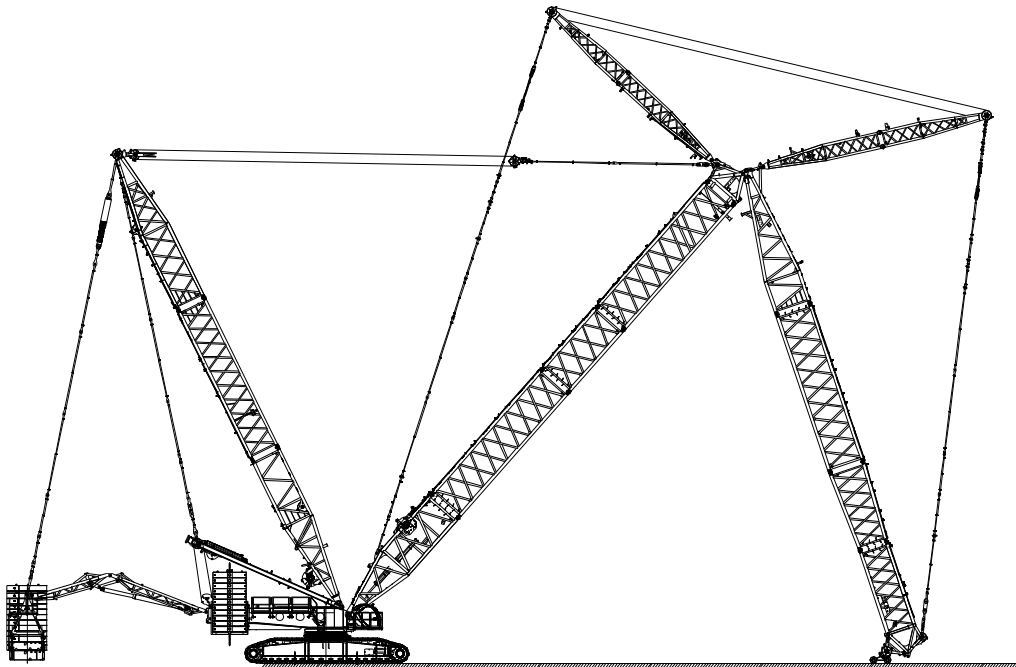
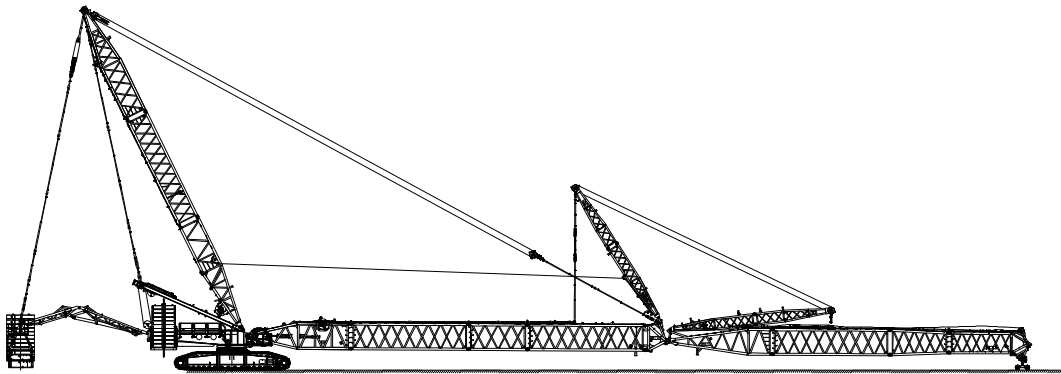



SCE8000A SANY CRAWLER CRANE 800 TONS LIFTING CAPACITY

QUALITY CHANGES THE WORLD

Configurations

- Page 29 Combination
- Page 33 ZHJFJDB Configuration
- Page 36 ZHJFJ Configuration
- Page 39 ZHJDB Configuration
- Page 42 ZHDB Configuration
- Page 45 ZLJDB Configuration
- Page 56 H Configuration
- Page 59 HDB Configuration
- Page 62 HJ Configuration
- Page 65 HJDB Configuration
- Page 68 HJFJ Configuration
- Page 71 LJ Configuration
- Page 79 LJDB Configuration
- Page 92 ZHEDB Configuration

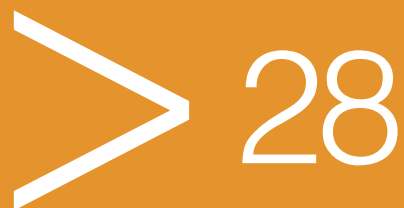

Combination

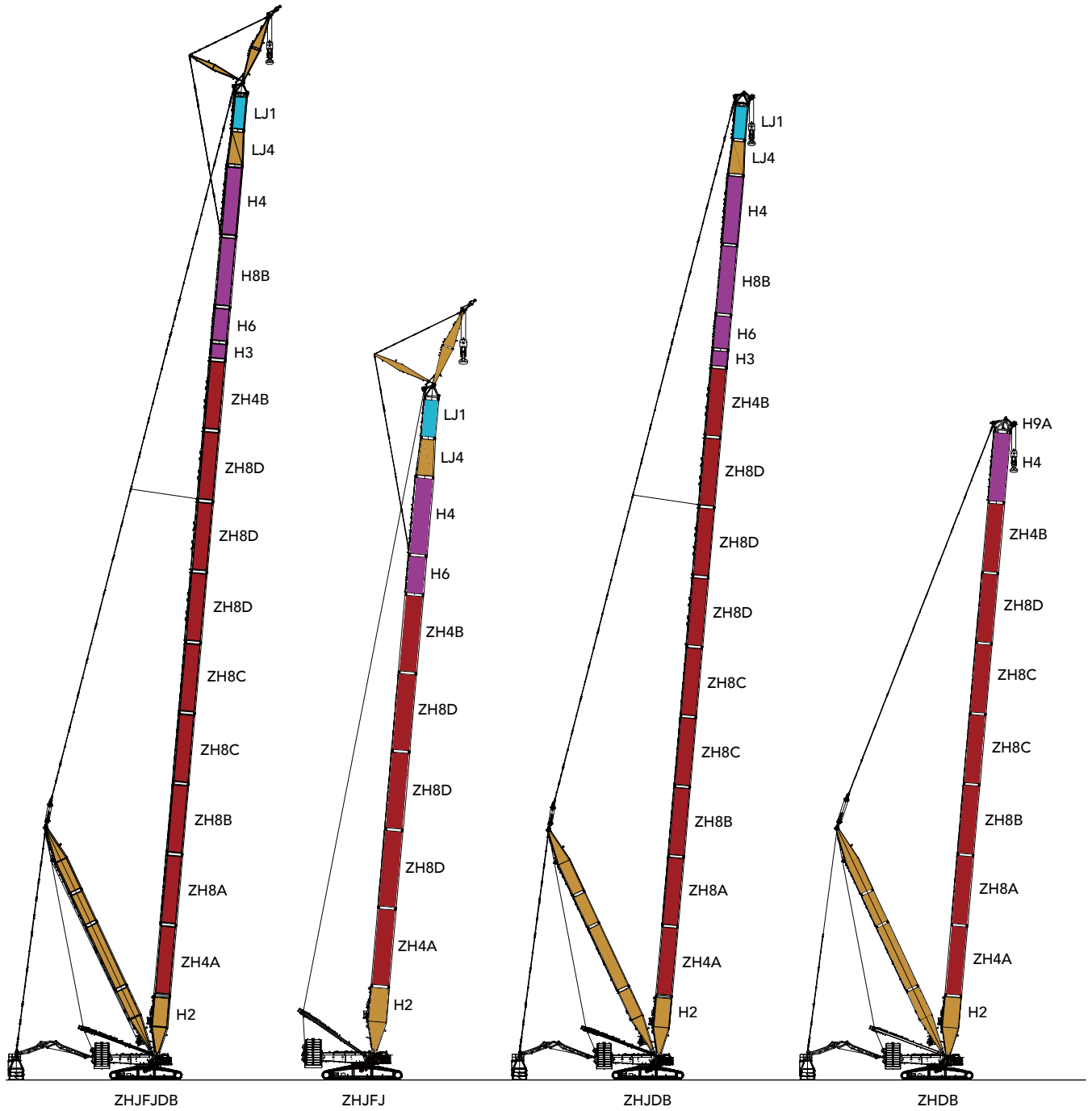

Configuration	Boom combination	Boom length
ZHJFJDB	Power boom+mixed boom+fixed jib+superlift mast+superlift counterweight	(102m+12m)~(165m+12m)
ZHJFJ	Power boom+mixed boom+fixed jib	(84m+12m)~(102m+12m)
ZHJDB	Power boom+mixed boom+superlift mast+superlift counterweight	(102m~165m)
ZHDB	Power boom+boom+superlift mast+superlift counterweight	(48m~108m)

The schematics above are reference for loading only.

Combination

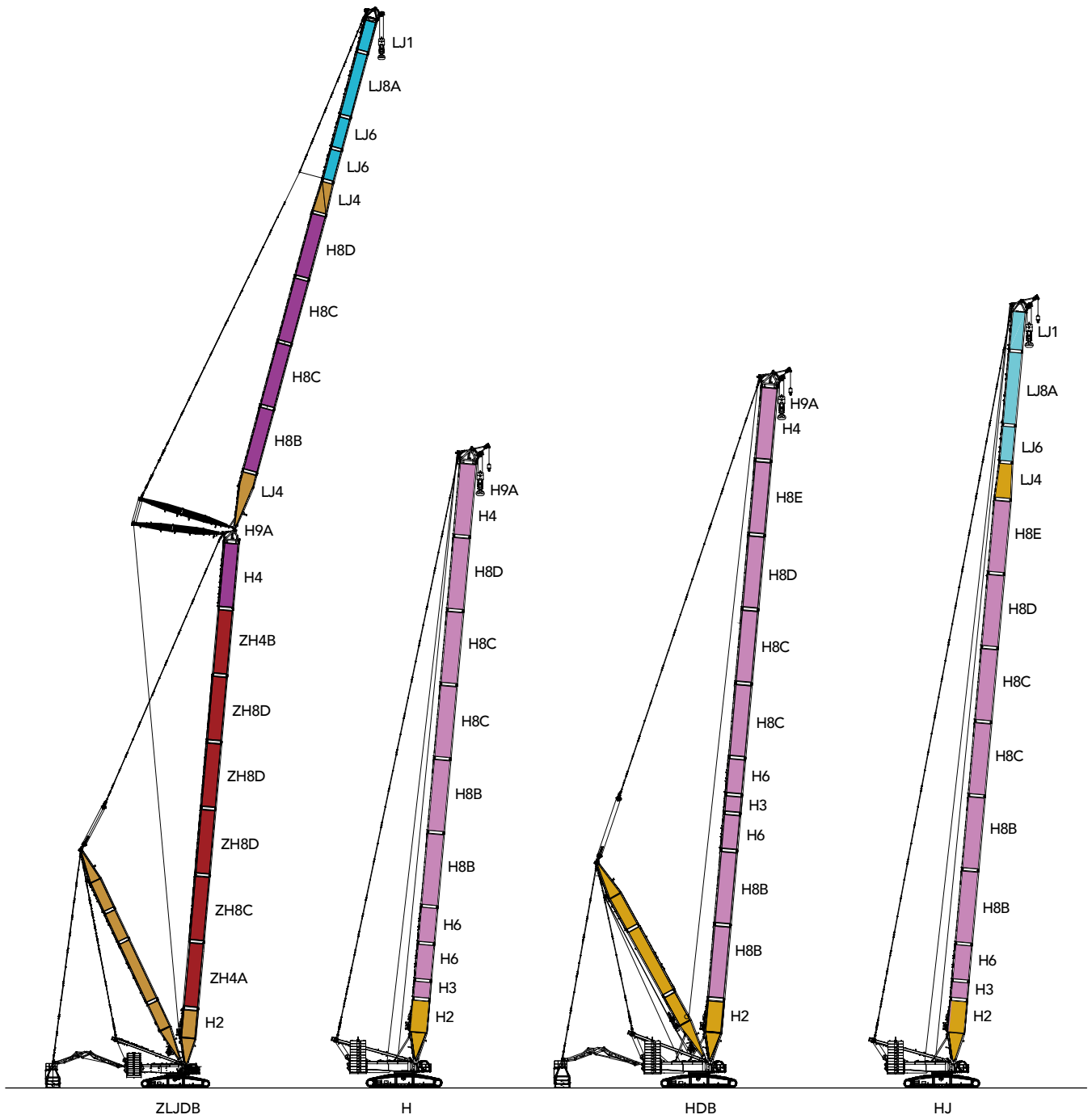

Configuration	Boom combination	Boom length
ZLJDB	Power boom+boom+luffing jib+superlift mast+superlift counterweight	(48m~96m)+(24m~96m)
H	Boom	(24m~99m)
HDB	Boom+superlift mast+superlift counterweight	(42m~111m)
HJ	Mixed boom	(84m~123m)

The schematics above are reference for loading only.

Combination

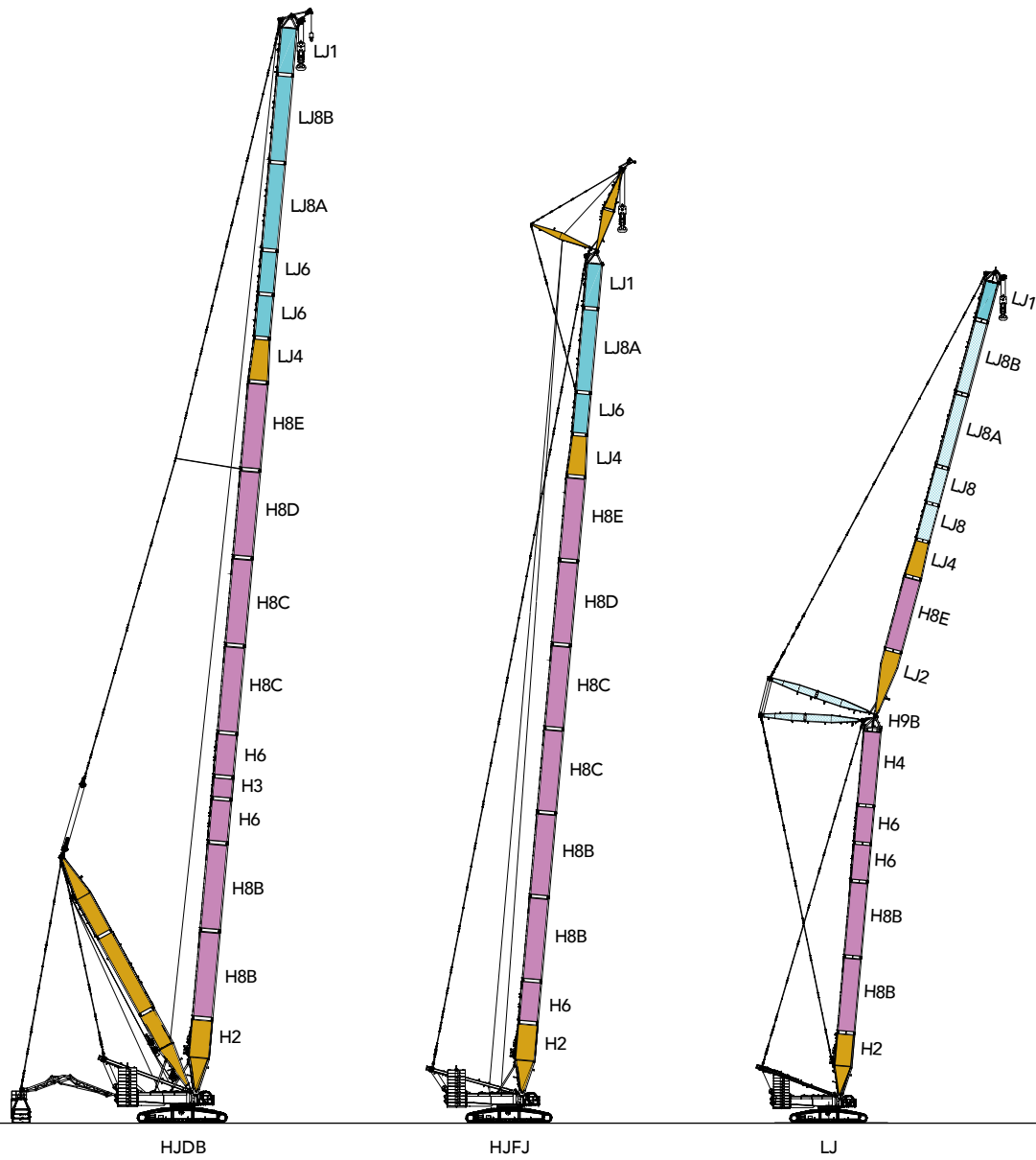

Configuration	Boom combination	Boom length
HJDB	Mixed boom+superlift mast+superlift counterweight	(90m~147m)
HJFJ	Mixed boom+fixed jib	(84m+12m)~(120m+12m)
LJ	Boom+luffing jib	(30m~60m)+(24m~72m)

The schematics above are reference for loading only.

Combination

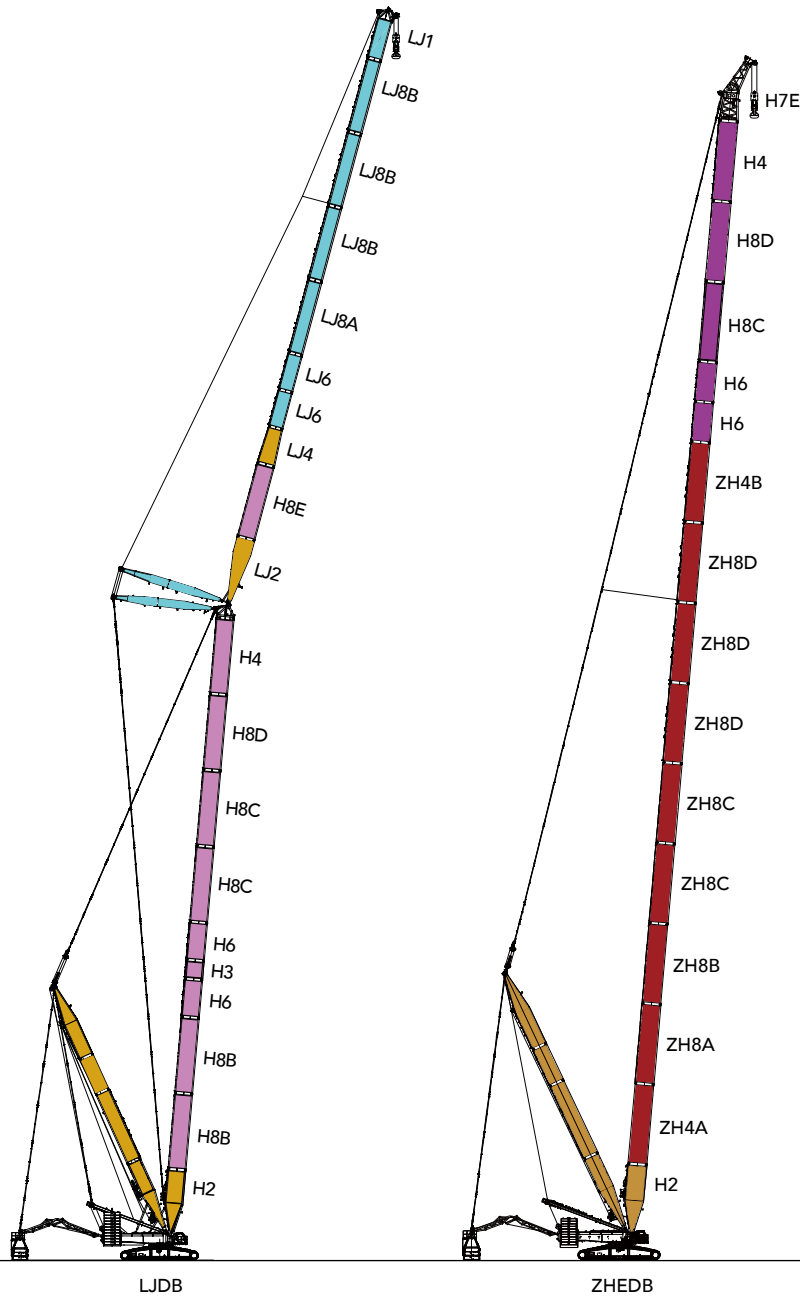

Configuration	Boom combination	Boom length
LJDB	Boom +luffing jib+superlift mast+superlift counterweight	(42m~99m)+(24m~96m)
ZHEDB	Power boom+boom+eagle tip+superlift mast+superlift counterweight	(93m+7m)~(171+7m)

The schematics above are reference for loading only.

Boom combination in ZHJFJDB

Boom combination in ZHJFJDB								
Boom length (m)	Power boom length				Boom insert length			
	12mA	12mB	12mC	12mD	3m	6m	12mB	
102	1	1	1	-	-	1	-	Fixed jib 12m
105	1	1	1	-	1	1	-	
108	1	1	2	-	-	-	-	
111	1	1	2	-	1	-	-	
114	1	1	2	-	-	1	-	
117	1	1	2	-	1	1	-	
120	1	1	2	1	-	-	-	
123	1	1	2	1	1	-	-	
126	1	1	2	1	-	1	-	
129	1	1	2	1	1	1	-	
132	1	1	2	2	-	-	-	
135	1	1	2	2	1	-	-	
138	1	1	2	2	-	1	-	
141	1	1	2	2	1	1	-	
144	1	1	2	3	-	-	-	
147	1	1	2	3	1	-	-	
150	1	1	2	3	-	1	-	
153	1	1	2	3	1	1	-	
156	1	1	2	3	-	-	1	
159	1	1	2	3	1	-	1	
162	1	1	2	3	-	1	1	
165	1	1	2	3	1	1	1	

Note: 10.5 m boom base, 12 m boom transition section, 12m power boom lower transition, 12m power boom upper transition, 6m tapered boom, luffing jib top are must.
In this working condition with boom length (141m+ 12m-165m +12m), the waist rope must be used, otherwise the boom frame may be broken.

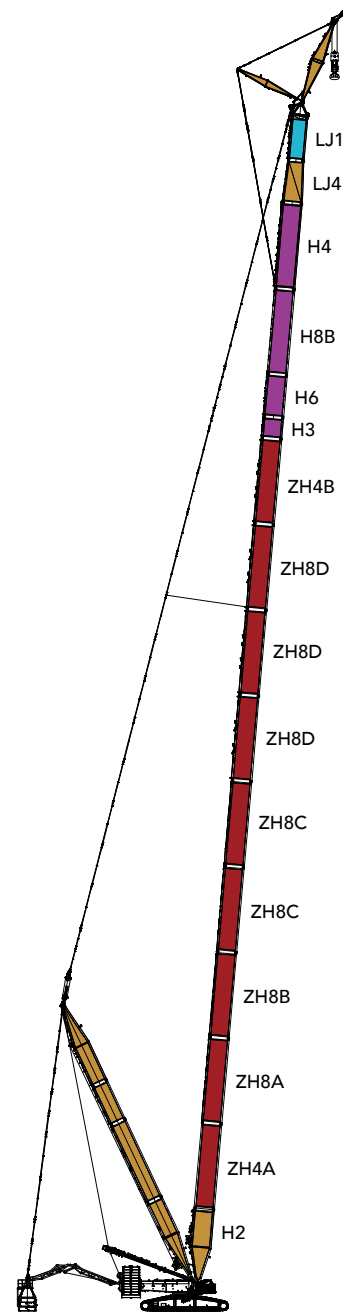

ZHJFJDB
(102m+12m)~(165m+12m)

ZHJFJDB working radius diagram

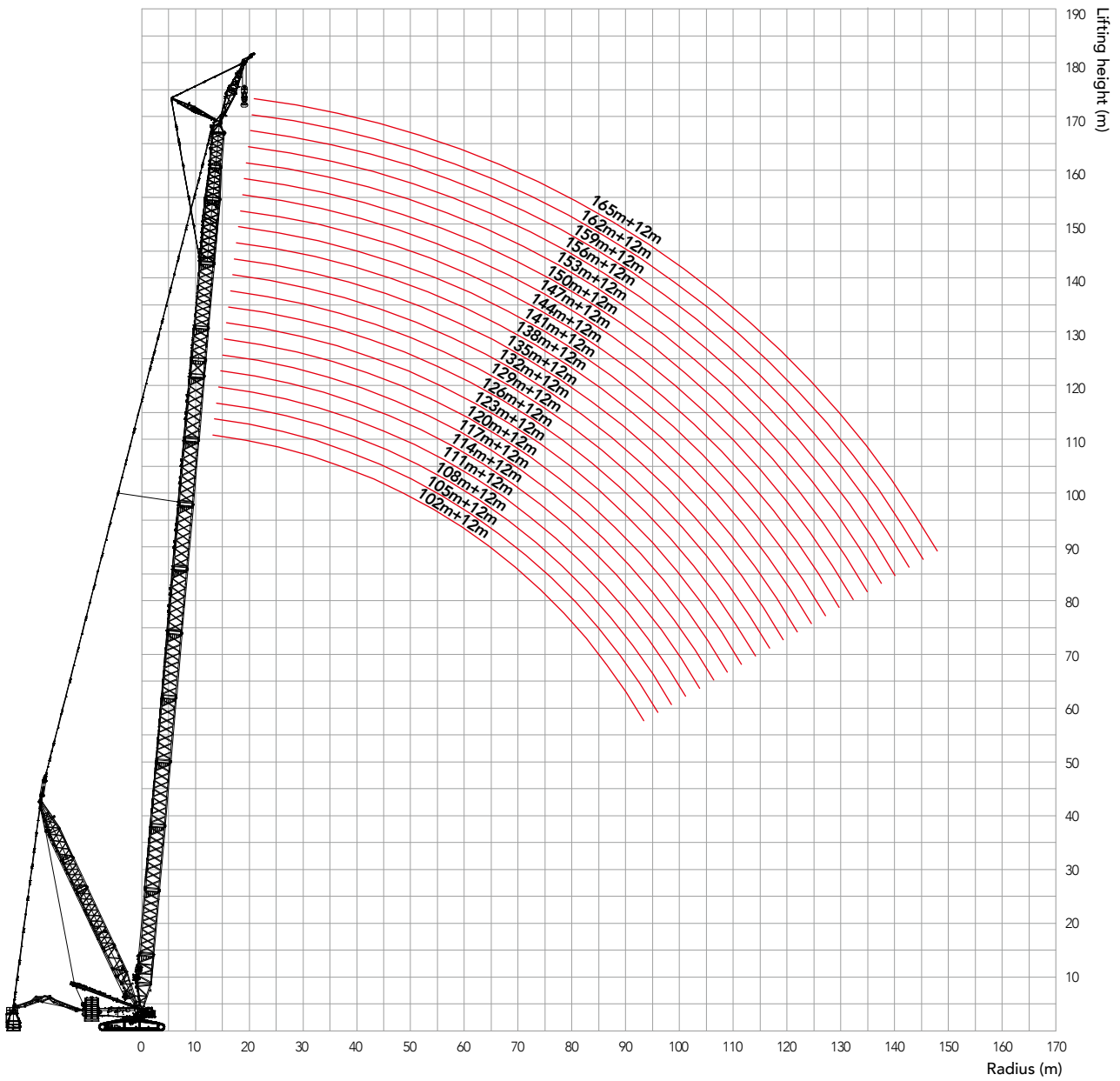

Unit: t

Load chart of ZHJFJDB configuration

Note:

- 1. Meet ISO 4305 standard;
- 2. The rated load in the table includes the weight of hook, wire rope and other spreader. The weight to be lifted is the sum of the rated load minus the weight of the above items.

ZHJFJDB Load Chart (Boom length 102~165m, Jib length 12m, Offset angle 15°, Superlift radius 22m, Superlift counterweight 390t, Rear counterweight 230t, Carbody counterweight 80t)																									
Radius (m)	102	105	108	111	114	117	120	123	126	129	132	135	138	141	144	147	150	153	156	159	162	165	Radius (m)		
14	240	240	240	240																			14		
15	240	240	240	240	233	223	217	206																15	
16	240	240	240	240	233	223	217	206	197	187	179													16	
17	240	240	240	239	234	223	217	206	197	187	179	172	163	156	151									17	
18	240	240	240	238	235	223	217	206	197	187	179	172	163	156	151	144	137	132	125					18	
19	240	239	239	238	235	224	217	206	197	187	180	172	164	156	151	144	137	132	125	119	114	108		19	
20	238	238	238	237	235	225	217	207	197	187	181	172	164	156	151	144	137	132	125	119	114	108		20	
22	233	233	234	234	232	225	218	207	198	188	181	173	164	157	151	144	138	132	125	119	113	108		22	
24	230	228	230	230	228	226	218	208	197	188	181	173	167	159	152	146	138	133	125	119	114	108		24	
26	226	224	225	225	225	224	219	208	198	189	182	175	167	159	153	145	139	133	125	120	114	108		26	
28	220	221	222	221	222	221	219	209	199	189	182	173	168	160	152	146	140	133	126	119	114	107		28	
30	216	217	218	218	218	218	218	209	200	189	183	174	168	160	153	147	140	134	126	119	113	107		30	
32	213	213	214	214	215	214	215	210	199	190	183	175	168	160	154	147	141	134	126	119	113	107		32	
34	209	209	210	211	203	210	207	203	199	190	184	175	168	160	154	147	140	134	126	119	113	106		34	
36	206	206	208	207	203	199	196	191	188	184	181	177	167	159	154	147	141	134	125	118	112	106		36	
38	201	202	201	196	193	188	185	181	178	174	171	168	165	159	155	146	141	134	125	118	112	105		38	
40	199	200	191	187	183	179	176	172	169	165	163	159	156	153	150	147	141	132	124	118	111	105		40	
44	186	182	179	175	172	168	160	156	153	150	147	144	141	138	136	133	130	127	124	117	110	104		44	
48	170	166	164	160	157	154	151	148	145	142	135	131	129	126	124	121	118	115	113	110	108	103		48	
52	165	162	150	147	144	150	139	136	133	130	128	125	123	120	113	110	108	105	103	100	98.7	96.1		52	
56	156	154	147	144	142	139	137	134	123	120	118	115	113	110	108	105	103	101	95.0	92.3	90.2	87.7		56	
60	145	142	140	137	131	128	127	124	121	119	117	106	104	102	100	97.7	95.5	92.9	91.3	88.8	86.7	84.2		60	
64	142	132	130	127	125	123	121	115	113	110	109	106	104	94.5	92.9	90.3	88.3	85.8	84.2	81.8	79.8	77.4		64	
68	132	130	121	118	117	114	113	110	108	106	101	99.0	96.9	94.4	92.9	90.3	81.8	79.3	77.9	75.5	73.6	71.2		68	
72	123	121	120	118	109	114	113	103	101	99.2	97.8	95.4	90.4	87.9	86.5	84.1	82.2	79.7	72.1	69.8	68.0	65.7		72	
76	114	113	112	110	108	106	105	103	101	92.6	91.3	89.0	87.2	84.9	83.6	78.3	76.5	74.2	72.8	70.5	68.7	60.6		76	
80	114	113	104	102	101	99.8	98.9	96.8	95.3	93.2	92.0	83.2	81.5	79.3	78.1	75.8	74.1	71.9	67.8	65.6	63.8	61.6		80	
84	106	105	104	95.9	94.9	93.2	92.5	90.6	89.2	87.2	86.2	84.1	82.5	74.1	72.9	70.8	69.1	67.0	65.8	63.6	59.3	57.2		84	
88	98.6	97.9	97.4	96.3	95.4	93.9	93.3	84.7	83.5	81.6	80.7	78.7	77.2	75.2	74.1	66.1	64.5	62.4	61.3	59.2	57.6	55.5		88	
92	93.4	92.2	90.6	89.7	89.1	87.8	87.3	85.8	84.6	76.4	75.6	73.7	72.3	70.4	69.4	67.4	65.9	58.2	57.1	55.1	53.5	51.5		92	
96	87.5	86.3	85.6	83.3	83.0	81.9	81.6	80.2	79.2	77.7	70.7	69.0	67.7	65.9	65.0	63.1	61.6	59.6	58.6	51.2	49.7	47.8		96	
100	82.0	80.9	80.1	78.9	78.2	77.0	76.1	74.9	74.1	72.7	72.1	70.5	63.3	61.5	60.8	58.9	57.6	55.7	54.8	52.8	51.4	44.2		100	
104	74.3	75.8	75.1	73.9	73.2	72.0	71.7	70.5	69.1	67.8	67.4	65.9	64.9	63.2	56.8	55.0	53.7	51.9	51.1	49.2	47.8	45.9		104	
108	69.7	68.5	70.4	69.2	68.5	67.3	67.1	65.8	65.1	63.9	62.9	61.6	60.6	59.1	58.5	51.3	50.1	48.3	47.6	45.8	44.4	42.6		108	
112	65.5	64.3	63.5	64.9	64.2	63.0	62.7	61.5	60.8	59.5	59.3	57.3	56.5	55.1	54.6	53.0	51.9	44.9	44.2	42.5	41.2	39.4		112	
116		60.3	59.6	58.4	57.6	58.9	58.7	57.5	56.7	55.5	55.3	54.0	53.2	51.2	50.9	49.4	48.4	46.8	46.1	39.3	38.1	36.4		116	
120			55.9	54.7	53.9	52.7	54.8	53.7	53.0	51.7	51.5	50.2	49.5	48.2	47.2	45.8	44.9	43.4	42.9	41.3	40.1	33.5		120	
124					50.5	49.2	49.0	50.0	49.3	48.2	48.0	46.7	45.9	44.7	44.4	43.1	41.6	40.1	39.7	38.2	37.1	35.5		124	
128						46.0	45.7	44.5	43.7	44.7	44.5	43.3	42.6	41.4	41.1	39.8	39.1	37.0	36.6	35.1	34.2	32.6		128	
132							42.6	41.4	40.7	39.4	41.3	40.1	39.4	38.2	38.0	36.7	35.9	34.7	34.4	32.2	31.3	29.9		132	
136								37.7	36.5	36.3	37.0	36.4	35.1	34.9	33.7	32.9	31.7	31.4	30.1	28.5	27.1			136	
140									33.8	33.5	32.3	31.5	32.3	32.1	30.8	30.1	28.8	28.5	27.3	26.5	25.2			140	
144										30.9	29.7	28.9	27.6	29.3	28.1	27.4	26.1	25.9	24.6	23.8	22.6			144	
148													26.4	25.2	25.0	25.5	24.8	23.5	23.3	22.0	21.3	20.0		148	
152														22.8	22.6	21.3	20.6	21.1	20.9	19.6	18.9	17.6		152	
156															20.4	19.1	18.3	17.0	18.5	17.3	16.5	15.3		156	
160																	16.2	14.9	14.7	15.0	14.3	13.1		160	
164																		12.9	12.6	11.4	10.6	11.0		164	
168																			10.7	9.4	8.7	7.4		168	
172																				6.8	5.5			172	
176																						3.7			176

Boom combination in ZHJFJ

Boom combination in ZHJFJ					
Boom length (m)	Power boom length	Boom insert length		Jib insert length	Fixed jib 12m
	12mD	3m	6m	6m	
84	2	-	-	1	Fixed jib 12m
87	2	1	-	1	
90	2	-	1	1	
93	2	1	1	1	
96	3	-	-	1	
99	3	1	-	1	
102	3	-	1	1	

Note: 10.5 m boom base, 12 m boom transition section, 12m power boom lower transition, 12m power boom upper transition, 6m tapered boom, and jib tip are must.

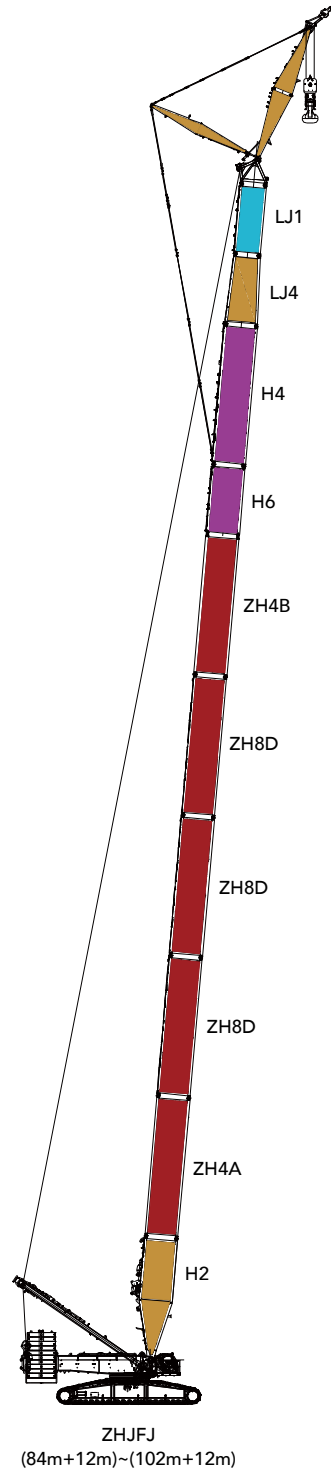

ZHJFJ working radius diagram

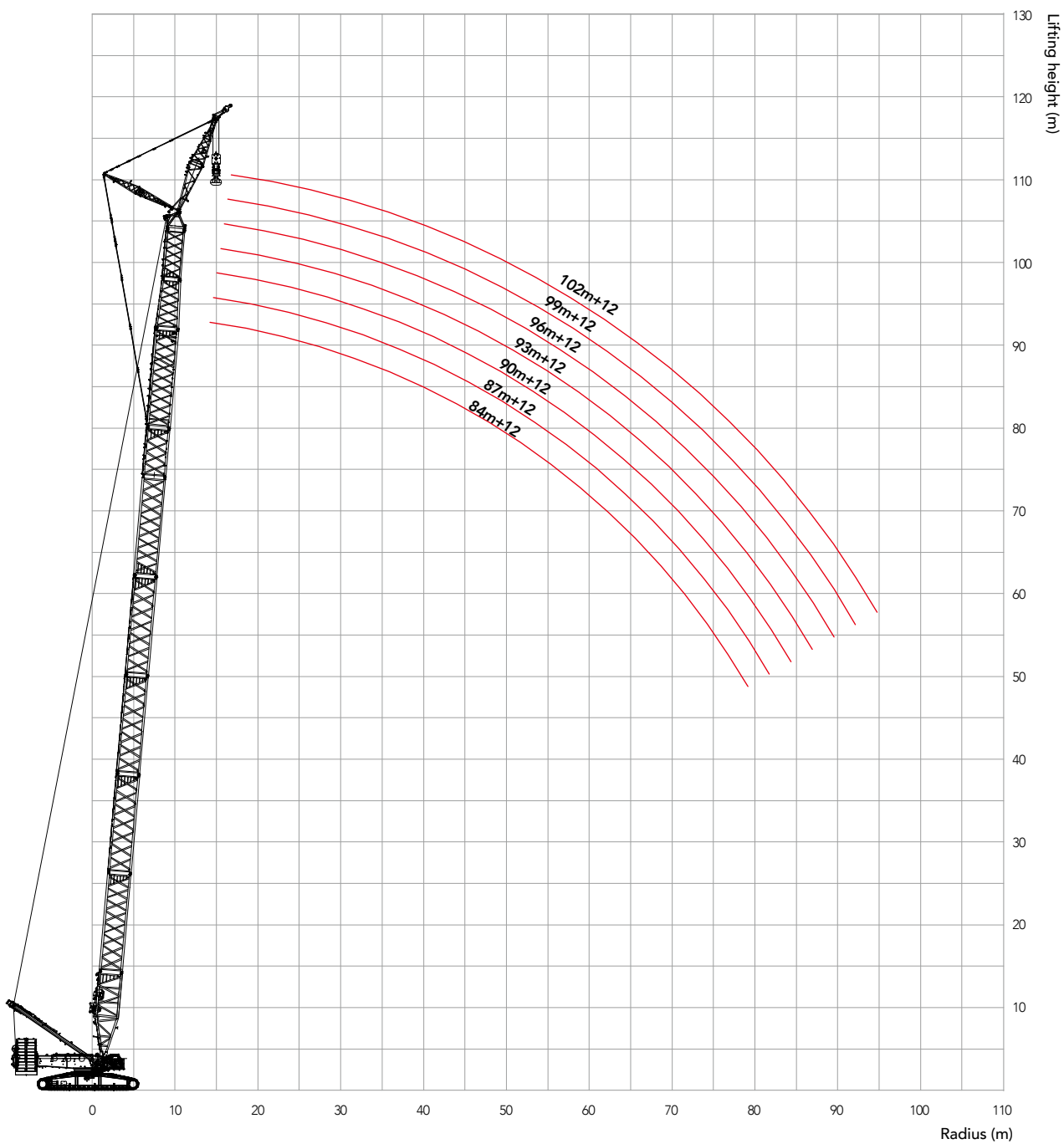

Load chart of ZHJFJ configuration

Note:

1. Meet ISO 4305 standard;
2. The rated load in the table includes the weight of hook, wire rope and other spreader. The weight to be lifted is the sum of the rated load minus the weight of the above items.

ZHJFJ Load Chart (Boom length 84~102m, Jib length 12m, Boom to jib angle 15°, Rear counterweight 230t, Carbody counterweight 80t, Additional rear counterweight 60t)								
Radius (m)	84	87	90	93	96	99	102	Radius (m)
14	240							14
15	237	238	240	240	240			15
16	231	233	234	236	238	236	223	16
17	225	227	229	231	230	226	220	17
18	220	222	224	220	217	214	210	18
19	215	214	211	208	205	202	199	19
20	201	200	199	197	195	192	189	20
22	178	177	176	175	174	173	171	22
24	159	157	156	155	155	154	153	24
26	142	141	140	139	139	137	137	26
28	129	128	127	126	125	124	123	28
30	117	116	115	114	113	112	111	30
32	107	106	105	104	103	102	101	32
34	98.6	97.3	96.4	95.1	94.6	93.3	92.4	34
36	90.8	89.5	88.5	87.3	86.7	85.4	84.5	36
38	83.8	82.5	81.5	80.2	79.7	78.4	77.4	38
40	85	83.7	75.2	74	73.4	72.1	71.1	40
44	73.4	72.1	71.2	69.9	69.4	68.1	60.3	44
48	63.8	62.5	61.5	60.3	59.7	58.4	57.5	48
52	55.7	54.4	53.4	52.2	51.6	50.3	49.4	52
56	53.5	52.3	46.5	45.2	44.7	43.4	42.4	56
60	47.1	45.9	45	43.7	43.2	37.4	36.4	60
64	41.4	40.2	39.3	38.1	37.6	36.3	35.4	64
68	36.4	35.2	34.3	33.1	32.6	31.3	30.4	68
72	31.9	30.7	29.9	28.6	28.2	26.9	26	72
76	27.9	26.7	25.8	24.6	24.2	22.9	22	76
80	24.2	23	22.2	21	20.6	19.3	18.4	80
84	20.8	19.7	18.9	17.7	17.3	16	15.1	84
88		16.6	15.8	14.7	14.3	13	12.2	88
92			13	11.8	11.5	10.3	9.4	92
96					8.9	7.7	6.8	96
100						5.3		100

Boom combination in ZHJDB

Boom combination in ZHJDB							
Boom length (m)	Power boom length				Boom insert length		
	12mA	12mB	12mC	12mD	3m	6m	12mB
102	1	1	1	-	-	1	-
105	1	1	1	-	1	1	-
108	1	1	2	-	-	-	-
111	1	1	2	-	1	-	-
114	1	1	2	-	-	1	-
117	1	1	2	-	1	1	-
120	1	1	2	1	-	-	-
123	1	1	2	1	1	-	-
126	1	1	2	1	-	1	-
129	1	1	2	1	1	1	-
132	1	1	2	2	-	-	-
135	1	1	2	2	1	-	-
138	1	1	2	2	-	1	-
141	1	1	2	2	1	1	-
144	1	1	2	3	-	-	-
147	1	1	2	3	1	-	-
150	1	1	2	3	-	1	-
153	1	1	2	3	1	1	-
156	1	1	2	3	-	-	1
159	1	1	2	3	1	-	1
162	1	1	2	3	-	1	1
165	1	1	2	3	1	1	1

Note: 10.5 m boom base, 12 m boom transition section, 12m power boom lower transition, 12m power boom upper transition, 6m tapered boom, luffing jib top are must .
In this working condition with boom length (141m-165m), the waist rope must be used, otherwise the boom frame may be broken.

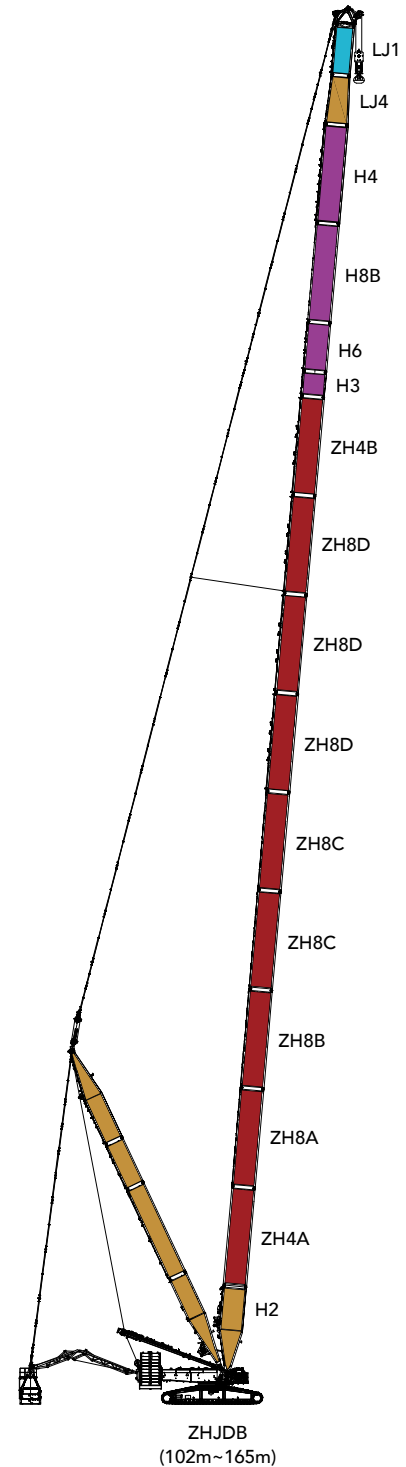

ZHJDB working radius diagram

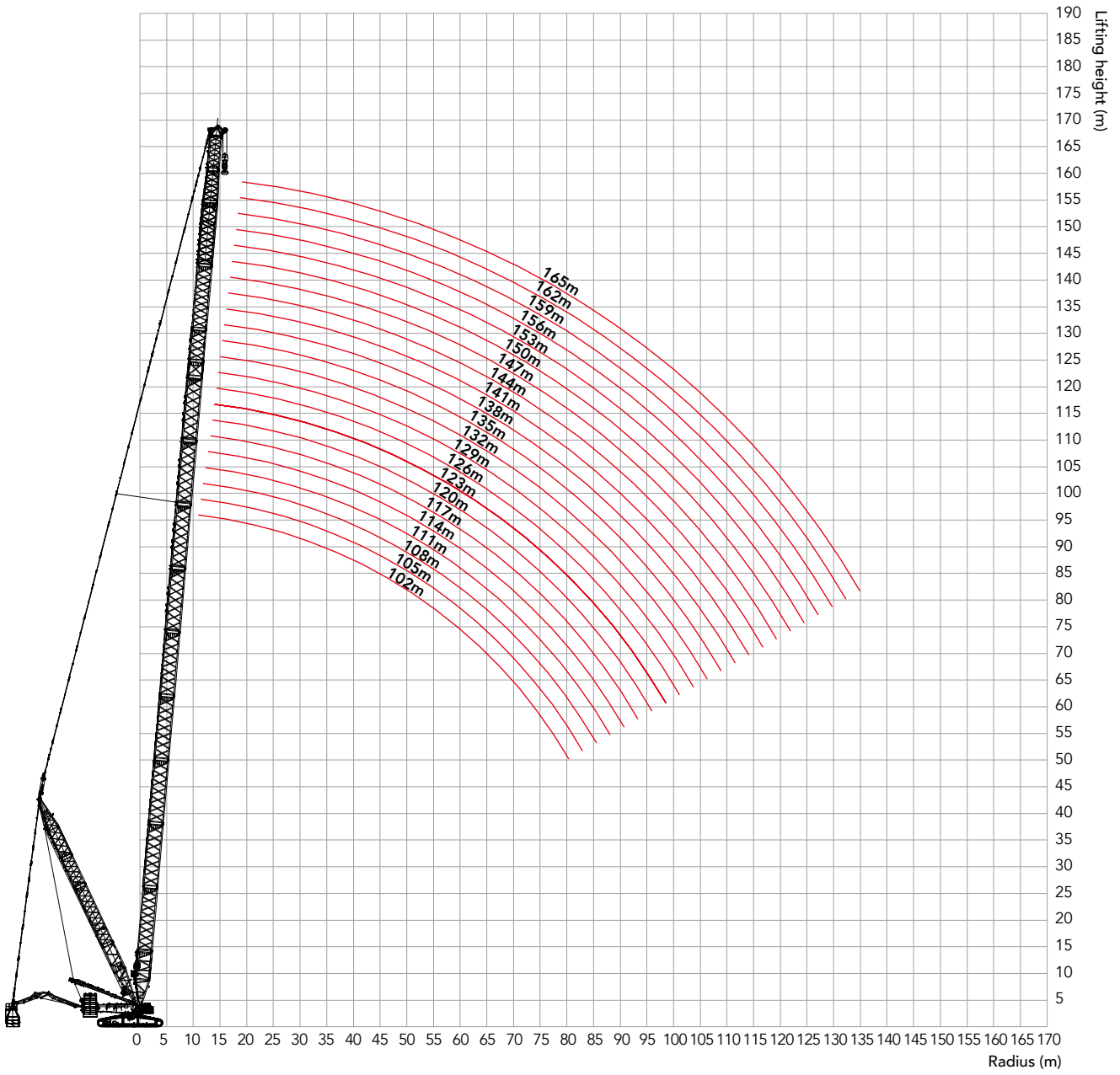

Unit: t

Load chart of ZHJDB configuration

Note:

1. Meet ISO 4305 standard;
2. The rated load in the table includes the weight of hook, wire rope and other spreader. The weight to be lifted is the sum of the rated load minus the weight of the above items.

ZHJDB Load Chart (Boom length 102~165m, Superlift Radius 22m, Superlift CWT 390t, Rear CWT 230t, Carbody CWT 80t)																							
Radius (m)	102	105	108	111	114	117	120	123	126	129	132	135	138	141	144	147	150	153	156	159	162	165	Radius (m)
13	326	326	294	294																			13
14	326	326	294	294	294	294	262																14
15	326	326	294	294	294	294	262	262	262	250	230												15
16	326	326	294	294	294	294	262	262	262	250	230	226	215	204	194								16
17	326	326	294	294	294	294	262	262	262	251	230	227	215	204	195	185	176	167	159				17
18	326	326	294	294	294	294	262	262	262	251	230	227	216	204	195	185	176	167	159	151	144	136	18
19	326	326	294	294	294	294	262	262	262	251	230	228	216	205	196	186	177	167	159	151	144	136	19
20	326	326	294	294	294	294	262	262	262	251	230	228	216	205	196	186	177	167	159	151	144	137	20
22	326	326	294	294	294	294	262	262	262	252	230	229	217	205	197	187	178	167	160	152	145	137	22
24	326	323	317	294	294	294	262	262	262	252	230	229	217	206	198	186	177	168	160	152	145	137	24
26	320	314	293	287	282	292	262	262	262	252	230	229	217	205	197	187	178	168	160	152	145	137	26
28	298	292	287	282	263	271	262	262	258	252	237	229	217	206	198	188	178	168	161	152	144	136	28
30	279	274	269	263	259	254	250	245	241	237	233	229	217	205	198	187	179	169	161	152	144	135	30
32	262	257	252	247	243	238	235	230	226	222	219	215	211	206	197	187	178	169	160	152	143	135	32
34	247	242	238	233	229	225	221	217	213	209	206	202	199	195	192	188	179	168	160	151	142	134	34
36	233	229	225	221	217	212	209	205	202	198	195	191	188	184	181	178	175	168	159	150	142	134	36
38	221	217	213	209	206	201	198	194	191	187	184	181	178	174	172	168	165	162	159	149	141	133	38
40	216	212	203	199	195	191	189	185	181	178	175	172	169	165	163	159	157	153	151	148	141	132	40
44	207	204	190	186	183	179	171	168	165	161	159	156	153	150	147	144	142	139	137	134	131	128	44
48	189	186	183	180	177	174	171	168	156	152	145	142	139	136	134	131	129	126	124	121	119	116	48
52	173	171	168	165	163	160	158	154	152	149	147	135	133	130	123	120	118	115	113	111	108	106	52
56	173	161	155	152	150	147	146	143	140	137	136	133	130	127	118	115	113	110	104	101	99.8	97.2	56
60	160	158	156	144	139	136	135	132	130	127	126	123	121	118	116	114	104	101	100	97.8	95.8	93.3	60
64	147	146	144	142	141	138	137	123	121	118	117	114	112	110	108	105	103	101	99.8	90.3	88.4	86.0	64
68	145	135	134	132	131	129	127	125	123	113	109	106	104	102	101	98.5	96.6	94.1	92.7	90.2	88.3	85.9	68
72	134	133	133	123	121	120	119	117	115	113	112	102	97.7	95.4	94.1	91.7	89.9	87.5	86.2	83.9	82.1	79.7	72
76	124	123	123	122	113	119	111	109	107	105	104	102	101	91.8	90.7	85.6	83.9	81.6	80.3	78.1	76.3	74.1	76
80	117	115	114	113	113	111	111	109	100	98.8	98.0	96.0	94.5	92.4	91.3	89.2	81.0	78.8	74.9	72.7	71.1	68.9	80
84	109	108	107	105	105	103	103	102	101	99.5	91.6	89.8	88.4	86.4	85.5	83.4	81.9	79.8	72.5	70.4	66.2	64.1	84
88	102	100	100	99.2	98.6	97.3	96.6	95.4	94.5	93.0	92.5	83.9	82.7	80.8	80.0	78.1	76.6	74.6	73.6	71.6	64.1	62.1	88
92		94.3	93.7	92.6	92.0	90.8	90.7	89.5	88.2	86.9	86.5	84.9	83.8	75.5	74.9	73.0	71.7	69.8	68.9	66.9	65.4	63.4	92
96			87.6	86.5	85.9	84.7	84.6	83.4	82.8	81.0	80.8	79.4	78.4	76.8	76.3	68.2	67.0	65.2	64.4	62.5	61.1	59.2	96
100				80.3	79.1	79.1	77.9	77.2	76.0	75.9	74.1	73.3	71.8	71.4	69.7	68.6	60.8	60.1	58.3	57.0	55.2	53.2	100
104						73.9	72.7	72.1	70.9	70.8	69.5	68.8	67.0	66.7	65.2	64.1	62.5	61.9	54.4	53.1	51.4	49.4	104
108							67.9	67.3	66.1	66.0	64.8	64.1	62.8	62.2	60.8	59.9	58.3	57.8	56.1	49.4	47.7	45.7	108
112									61.7	61.6	60.3	59.7	58.4	58.3	57.0	55.7	54.3	53.9	52.3	51.2	49.6	47.6	112
116											57.4	56.2	55.5	54.3	54.2	52.9	52.2	50.4	48.6	47.6	46.1	44.2	116
120													48.8	50.4	50.3	49.0	48.3	47.0	46.8	45.0	44.2	42.7	120
124														46.8	46.7	45.4	44.7	43.4	43.2	42.0	41.2	39.4	124
128																42.0	41.3	40.0	39.8	38.6	37.8	36.6	128
132																	38.1	36.8	36.7	35.4	34.7	33.4	132
136																			33.6	32.4	31.6	30.4	136
140																				29.5	28.8	27.5	140
144																						24.8	144

Boom combination in ZHDB

Boom combination in ZHDB					
Boom length (m)	Power boom length				Boom insert length
	12mA	12mB	12mC	12mD	6m
48	-	-	-	-	-
54	-	-	-	-	1
60	1	-	-	-	-
66	1	-	-	-	1
72	1	1	-	-	-
78	1	1	-	-	1
84	1	1	1	-	-
90	1	1	1	-	1
96	1	1	2	-	-
102	1	1	2	-	1
108	1	1	2	1	-

Note: 10.5 m boom base, 12 m boom transition section, 12m power boom lower transition, 12m power boom upper transition, 800t pulley and boom connecting tip are must.

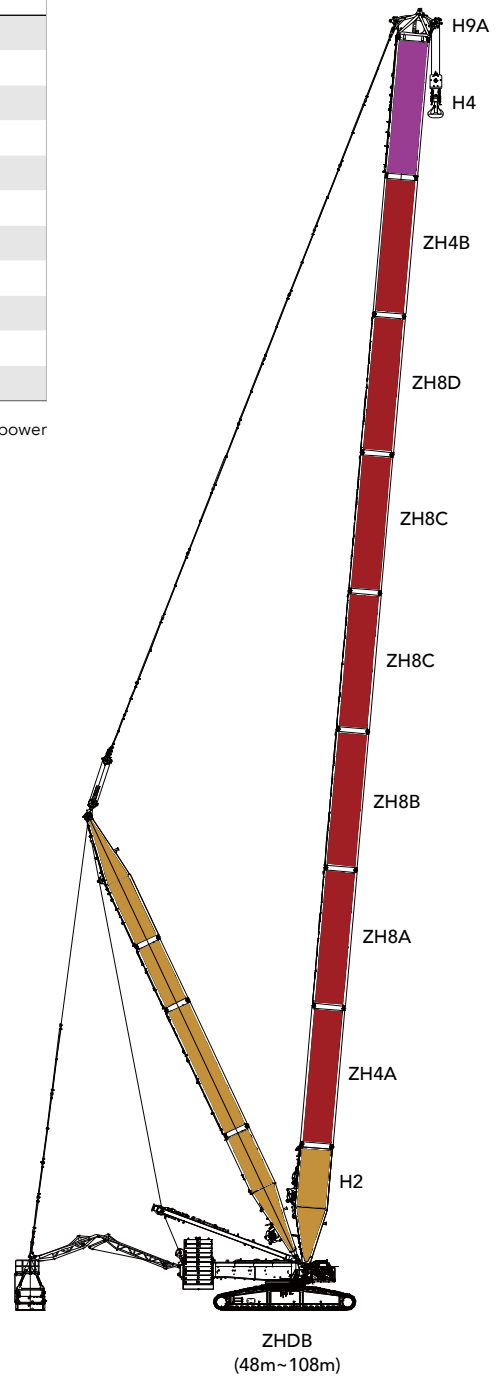

ZHDB working radius diagram

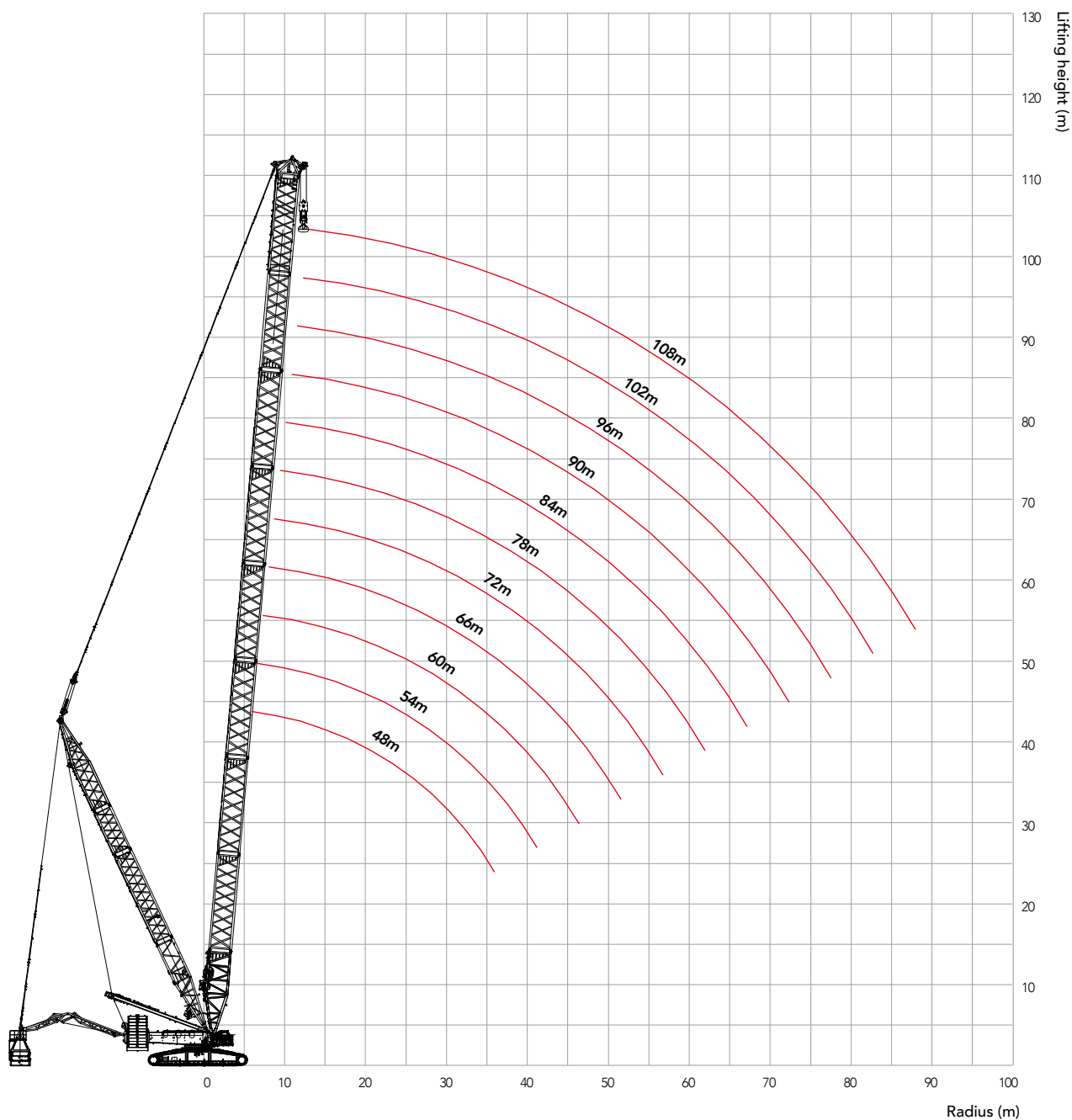

Load chart of ZHDB configuration

Note:

1. Meet ISO 4305 standard;
2. The rated load in the table includes the weight of hook, wire rope and other spreader. The weight to be lifted is the sum of the rated load minus the weight of the above items.

ZHDB Load Chart (Boom length 48~108m, Superlift radius 22m, Superlift counterweight 390t, Rear counterweight 230t, Carbody counterweight 80t)													
Radius (m)	48	54	60	66	72	78	84	90	96	102	108	Radius (m)	
8	697											8	
9	697	636	576									9	
10	697	636	576	514	452							10	
11	697	636	576	514	452	421	389					11	
12	697	636	576	514	483	421	389	358	358			12	
13	697	636	576	514	483	421	389	358	358	326		13	
14	755	636	576	514	483	421	389	358	358	326	294	14	
15	755	636	576	514	483	421	389	358	358	326	294	15	
16	707	636	576	514	483	421	389	358	358	326	294	16	
17	692	636	576	514	483	421	389	358	358	326	294	17	
18	646	596	576	514	483	421	389	358	358	326	294	18	
19	605	560	576	514	483	452	389	358	358	326	294	19	
20	581	554	550	511	483	452	389	389	358	326	294	20	
22	517	507	495	461	445	428	409	373	357	326	294	22	
24	490	458	449	420	407	392	376	361	328	315	294	24	
26	443	415	441	385	375	362	348	334	320	292	280	26	
28	411	400	405	364	347	336	323	311	298	286	261	28	
30	396	367	373	354	347	313	302	291	279	268	258	30	
32	363	344	346	329	324	316	283	273	262	252	242	32	
34	333	318	346	307	303	297	288	257	247	238	229	34	
36	326	311	322	287	284	279	271	249	234	225	216	36	
38	300	288	300	289	267	263	257	249	228	213	205	38	
40	291	283	288	271	271	248	243	236	216	208	195	40	
44	261	244	258	239	241	240	219	214	207	189	183	44	
48		223	233	224	228	216	214	194	189	183	177	48	
52			212	211	205	207	194	192	177	168	163	52	
56				187	191	187	188	175	172	158	150	56	
60					174	174	171	170	158	155	142	60	
64					162	160	159	156	146	143	140	64	
68						148	147	143	143	132	130	68	
72							136	134	132	131	120	72	
76								125	123	121	120	76	
80									116	114	113	80	
84										106	105	84	
88											98.1	88	
92												92	
96												84.5	96

Boom combination in ZLJDB

ZLJDB configuration boom combination			
Boom length (m)	Power boom length		Boom insert length
	12mC	12mD	6m
48	-	-	-
54	-	-	1
60	-	1	-
66	-	1	1
72	-	2	-
78	-	2	1
84	-	3	-
90	-	3	1
96	1	3	-

Note: 10.5 m boom base, 12 m boom transition section, 12m power boom lower transition, 12m power boom upper transition, 1.5m boom tip are must.

ZLJDB configuration Jib combination					
Boom length (m)	Boom insert length			Jib insert length	
	12mB	12mC	12mD	6m	12mA
24	-	-	-	-	-
30	-	-	-	1	-
36	-	-	1	-	-
42	-	-	1	1	-
48	-	1	1	-	-
54	-	1	1	1	-
60	1	1	1	-	-
66	1	1	1	1	-
72	1	2	1	-	-
78	1	2	1	1	-
84	1	2	1	2	-
90*	1	2	1	1	1
96*	1	2	1	2	1

Note: 10.5 m boom base, 6m tapered boom, 500t pulley, luffing jib top are must.

In this working condition, the waist rope must be used, otherwise the boom frame may be broken.

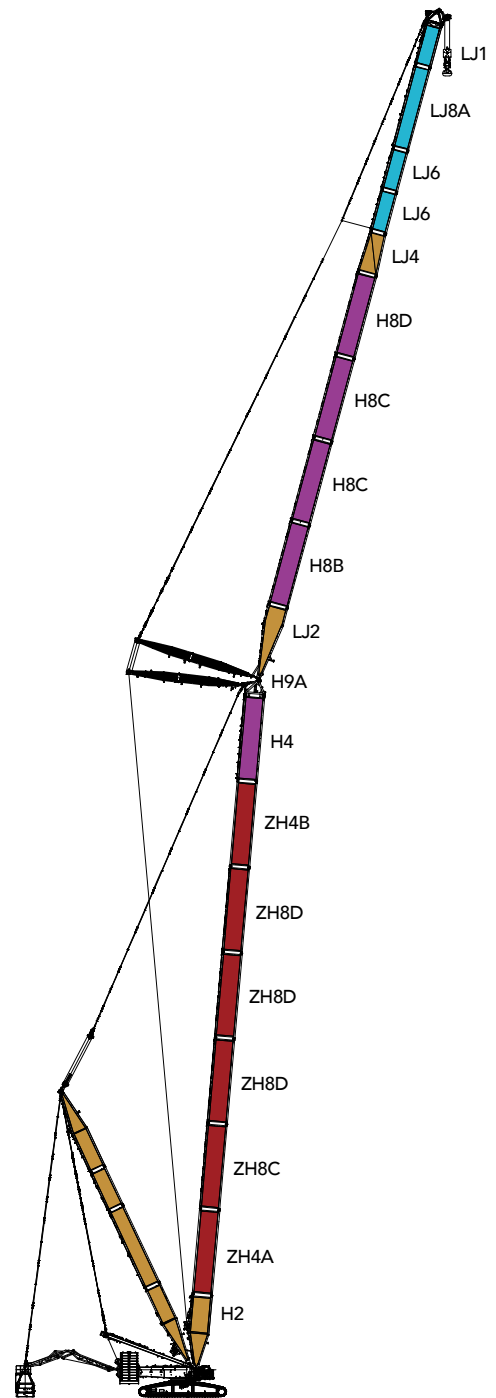

ZLJDB
(48m-96m)+(24m-96m)

ZLJDB working radius diagram

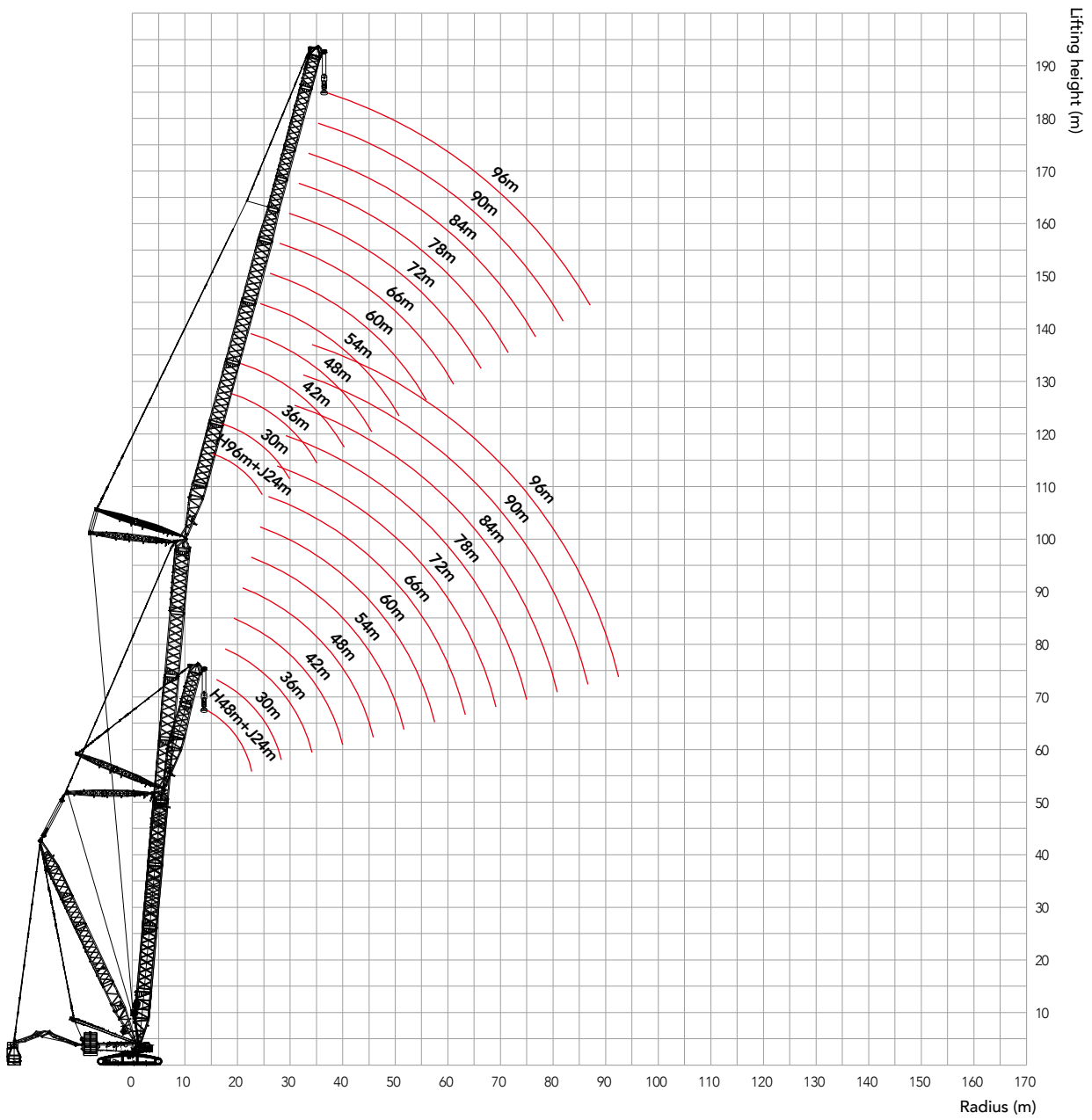

Unit: t

Load chart of ZLJDB configuration

Note:

1. Meet ISO 4305 standard;
2. The rated load in the table includes the weight of hook, wire rope and other spreader. The weight to be lifted is the sum of the rated load minus the weight of the above items.

ZLJDB Load Chart - 1/9 (Boom angle 85°, Jib length 24~96m, Superlift radius 22m, Superlift counterweight 390t, Rear counterweight 230t, Carbody counterweight 80t)														
Boom length 48m														
Radius (m)	24	30	36	42	48	54	60	66	72	78	84	90	96	Radius (m)
15	403													15
16	403	409												16
17	386	402												17
18	369	396	389											18
19	354	381	389	341										19
20	340	367	389	341										20
22	316	342	361	339	299	254								22
24	294	322	333	329	298	253	227							24
26	280	306	307	305	295	252	227	195						26
28	267	285	288	283	281	251	226	195	172					28
30		259	266	265	261	248	224	194	172	149	129			30
32		238	239	248	237	237	223	193	171	149	128	114		32
34		220	229	226	229	228	217	191	170	148	128	113	99.3	34
36			207	206	211	211	200	190	169	147	127	113	98.7	36
38			198	200	194	194	195	185	167	146	126	112	98.2	38
40			176	183	179	180	181	172	166	145	125	111	97.6	40
44				163	162	155	157	159	149	142	123	109	96.2	44
48					138	143	136	139	139	131	121	108	94.6	48
52					123	123	127	122	123	123	110	106	93.0	52
56						112	111	115	109	110	97.3	103	91.2	56
60							103	101	103	98.4	87.4	95.7	89.3	60
64							93.8	95.7	92.0	94.2	77.9	89.0	85.1	64
68								82.8	81.2	84.2	69.8	81.2	78.9	68
72									76.6	74.9	61.8	73.1	73.4	72
76									69.6	70.1	55.2	69.4	66.5	76
80										61.9	49.7	63.8	63.1	80
84											44.1	57.0	58.1	84
88												53.5	52.5	88
92												47.7	49.1	92
96													44.9	96

Load chart of ZLJDB configuration

Note:

1. Meet ISO 4305 standard;
2. The rated load in the table includes the weight of hook, wire rope and other spreader. The weight to be lifted is the sum of the rated load minus the weight of the above items.

ZLJDB Load Chart - 2/9 (Boom angle 85°, Jib length 24~96m, Superlift radius 22m, Superlift counterweight 390t, Rear counterweight 230t, Carbody counterweight 80t)

Boom length 54m														
Radius (m)	24	30	36	42	48	54	60	66	72	78	84	90	96	Radius (m)
15	410													15
16	410													16
17	392	389												17
18	374	389	358											18
19	358	384	358											19
20	342	370	358	308										20
22	318	345	356	306	270									22
24	298	324	327	304	269	231	206							24
26	281	305	303	299	267	230	206	178						26
28	268	284	282	278	264	228	205	178	157					28
30	257	265	264	261	251	226	204	177	157	137				30
32		243	247	243	238	222	202	176	156	137	119	105		32
34		224	233	229	224	211	200	175	156	136	118	105	92.0	34
36		208	214	212	210	200	190	174	155	135	117	105	91.7	36
38			202	202	197	188	181	170	154	135	117	104	91.3	38
40			183	188	183	178	171	163	152	134	116	103	90.8	40
44				162	161	158	154	148	140	131	114	102	89.7	44
48					140	139	137	133	128	123	112	101	88.4	48
52					122	123	122	120	117	112	107	99.2	87.0	52
56						108	109	108	105	102	98.2	94.2	85.5	56
60							96.0	96.5	95.1	93.7	87.7	87.5	83.0	60
64							84.9	86.5	85.9	84.7	78.6	80.4	77.3	64
68								76.8	77.4	76.9	69.8	74.5	72.1	68
72									69.3	69.8	62.4	68.2	66.3	72
76									62.3	63.2	56.1	62.5	61.3	76
80										56.8	50.0	57.4	56.5	80
84											44.8	52.0	51.7	84
88												40.1	47.4	88
92													43.3	92
96														96
100														100

Unit: t

Load chart of ZLJDB configuration

Note:

1. Meet ISO 4305 standard;
2. The rated load in the table includes the weight of hook, wire rope and other spreader. The weight to be lifted is the sum of the rated load minus the weight of the above items.

ZLJDB Load Chart - 3/9 (Boom angle 85°, Jib length 24~96m, Superlift radius 22m, Superlift counterweight 390t, Rear counterweight 230t, Carbody counterweight 80t)														
Boom length 60m														
Radius (m)	24	30	36	42	48	54	60	66	72	78	84	90	96	Radius (m)
16	389													16
17	389	358												17
18	380	358												18
19	364	358	345											19
20	349	366	345	292										20
22	323	334	332	291	256									22
24	303	307	305	288	255	220								24
26	284	285	281	277	253	219	196							26
28	268	265	262	258	251	218	195	171	150					28
30	250	247	245	241	238	216	194	170	150	131				30
32		233	230	226	224	213	193	169	150	131	114			32
34		219	217	213	210	201	191	168	149	130	114	101	88.5	34
36		207	204	201	198	191	182	167	148	130	113	101	88.3	36
38			194	190	187	181	173	163	147	129	113	100	87.9	38
40			180	179	176	170	164	156	146	128	112	100	87.5	40
44				154	153	150	147	141	134	126	110	98.9	86.6	44
48				132	133	133	130	127	122	116	108	97.4	85.4	48
52					115	116	115	113	111	107	102	95.8	84.1	52
56						102	102	102	99.9	97.3	93.6	89.9	82.7	56
60						89.8	90.8	91.1	89.7	88.4	85.7	83.0	79.0	60
64							80.5	81.1	81.0	80.2	78.1	76.2	73.2	64
68								72.4	72.7	72.3	70.6	70.1	67.8	68
72									64.7	65.0	63.3	64.0	62.5	72
76									58.1	59.0	57.3	58.2	57.4	76
80										52.7	51.3	53.0	52.7	80
84											45.5	48.7	48.2	84
88											41.0	44.0	44.2	88
92												39.9	40.2	92
96													36.9	96
100													33.6	100

Load chart of ZLJDB configuration

Note:

1. Meet ISO 4305 standard;
2. The rated load in the table includes the weight of hook, wire rope and other spreader. The weight to be lifted is the sum of the rated load minus the weight of the above items.

ZLJDB Load Chart - 4/9 (Boom angle 85°, Jib length 24~96m, Superlift radius 22m, Superlift counterweight 390t, Rear counterweight 230t, Carbody counterweight 80t)														
Boom length 66m														
Radius (m)	24	30	36	42	48	54	60	66	72	78	84	90	96	Radius (m)
16	358													16
17	358													17
18	358	354												18
19	369	352	307											19
20	354	349	307											20
22	328	326	304	261	231									22
24	304	300	297	259	230	199								24
26	281	278	275	256	228	198	178							26
28	263	260	257	249	225	197	177	155						28
30	245	242	238	234	220	195	176	154	136	120				30
32		228	224	219	208	193	175	154	136	120	104			32
34		214	211	205	197	186	173	153	135	119	104	93.0		34
36		200	196	190	185	175	166	151	134	119	104	92.8	81.4	36
38			182	178	173	166	159	149	133	118	103	92.4	81.1	38
40			168	165	162	156	150	143	132	117	103	92.0	80.8	40
44				143	141	138	134	130	123	115	101	91.0	80.0	44
48				123	123	122	120	116	112	107	99.9	89.7	79.0	48
52					106	107	106	104	101	98.3	93.7	88.1	77.9	52
56						94.2	94.5	93.8	91.4	89.3	85.9	82.3	76.5	56
60						83.1	83.4	83.4	82.1	80.5	78.7	76.1	72.3	60
64							73.7	74.0	73.7	72.5	71.1	69.8	66.8	64
68								66.0	66.1	65.9	64.8	63.7	61.8	68
72								58.7	58.7	59.4	58.8	58.2	57.0	72
76									52.9	53.1	53.2	52.8	51.8	76
80										47.8	48.3	48.0	47.6	80
84											43.4	43.7	43.4	84
88											39.2	39.5	39.5	88
92												36.0	36.2	92
96													32.7	96
100													29.6	100

Unit: t

Load chart of ZLJDB configuration

Note:

1. Meet ISO 4305 standard;
2. The rated load in the table includes the weight of hook, wire rope and other spreader. The weight to be lifted is the sum of the rated load minus the weight of the above items.

ZLJDB Load Chart - 5/9 (Boom angle 85°, Jib length 24~96m, Superlift radius 22m, Superlift counterweight 390t, Rear counterweight 230t, Carbody counterweight 80t)														
Boom length 72m														
Radius (m)	24	30	36	42	48	54	60	66	72	78	84	90	96	Radius (m)
17	358													17
18	358	326												18
19	358	326												19
20	353	326	288											20
22	322	319	285	247										22
24	295	293	280	244	217	189								24
26	273	270	267	241	215	189	169							26
28	254	251	248	236	213	187	168	147						28
30	238	235	231	222	210	186	167	147	130					30
32	221	220	217	209	199	184	166	146	130	114	100			32
34		207	202	195	187	177	164	145	129	114	100	89.2		34
36		191	187	181	175	167	160	144	128	113	99.7	89.0	77.9	36
38			173	169	164	158	151	143	127	113	99.2	88.7	77.7	38
40			160	158	154	149	143	136	126	112	98.7	88.3	77.5	40
44				135	135	132	128	123	118	110	97.3	87.3	76.8	44
48				117	117	116	114	111	107	102	95.6	86.1	75.8	48
52					101	102	100	99.1	96.4	93.0	89.1	84.6	74.7	52
56						89.2	89.0	88.7	86.5	84.4	81.5	78.5	73.4	56
60						78.6	78.6	79.0	77.6	76.5	74.3	71.9	68.9	60
64							69.8	70.1	69.6	68.8	67.5	65.9	63.3	64
68								62.1	61.9	61.9	61.0	60.0	58.1	68
72								55.0	55.5	55.4	55.1	54.7	53.4	72
76									49.7	49.9	49.8	49.5	48.9	76
80										44.6	45.1	44.9	44.5	80
84											40.2	40.5	40.5	84
88												36.3	37.0	88
92													33.4	92
96														96
100														100

Load chart of ZLJDB configuration

Note:

1. Meet ISO 4305 standard;
2. The rated load in the table includes the weight of hook, wire rope and other spreader. The weight to be lifted is the sum of the rated load minus the weight of the above items.

ZLJDB Load Chart - 6/9 (Boom angle 85°, Jib length 24~96m, Superlift radius 22m, Superlift counterweight 390t, Rear counterweight 230t, Carbody counterweight 80t)														
Boom length 78m														
Radius (m)	24	30	36	42	48	54	60	66	72	78	84	90	96	Radius (m)
17	326													17
18	326													18
19	326	290												19
20	326	290	256											20
22	314	285	253	221										22
24	288	278	249	219	195									24
26	266	263	244	216	193	170								26
28	247	244	233	212	191	169	151	133						28
30	232	227	217	205	188	167	150	133	117					30
32	217	210	202	192	182	165	149	132	117	103				32
34		193	187	180	172	162	147	131	116	103	91.0	81.0		34
36		178	174	168	162	154	145	130	116	102	90.7	80.9	70.8	36
38		164	161	157	153	146	139	129	115	102	90.3	80.6	70.7	38
40			149	146	143	137	132	125	113	101	89.7	80.3	70.5	40
44			128	127	124	122	118	113	108	99.6	88.4	79.3	70.0	44
48				109	108	108	104	102	98.3	93.7	86.8	78.1	69.1	48
52					95.5	94.3	93.4	91.4	88.5	85.3	81.7	76.7	68.0	52
56						82.9	82.2	82.0	79.5	77.3	74.7	71.9	66.8	56
60						72.7	73.0	73.0	71.3	70.1	67.8	65.8	63.0	60
64							64.2	64.4	63.7	63.1	61.6	60.2	58.1	64
68								57.4	56.8	56.8	55.6	54.9	53.3	68
72								51.0	50.7	50.8	50.6	49.6	48.6	72
76									45.3	45.5	45.5	45.3	44.3	76
80										40.8	40.9	41.1	40.2	80
84										36.5	36.9	37.0	36.7	84
88											33.2	33.5	33.2	88
92												30.0	30.1	92
96												27.2	27.1	96
100													24.4	100

Unit: t

Load chart of ZLJDB configuration

Note:

1. Meet ISO 4305 standard;
2. The rated load in the table includes the weight of hook, wire rope and other spreader. The weight to be lifted is the sum of the rated load minus the weight of the above items.

ZLJDB Load Chart - 7/9 (Boom angle 85°, Jib length 24~96m, Superlift radius 22m, Superlift counterweight 390t, Rear counterweight 230t, Carbody counterweight 80t)														
Boom length 84m														
Radius (m)	24	30	36	42	48	54	60	66	72	78	84	90	96	Radius (m)
18	294													18
19	294	268												19
20	294	268												20
22	294	263	235	207										22
24	281	257	231	205	182									24
26	261	249	226	202	181	159								26
28	243	232	220	198	178	158	142							28
30	226	215	206	194	176	157	141	125	110					30
32	209	199	192	183	172	155	139	124	110	97.9				32
34		184	179	171	164	152	138	123	109	97.5	85.8			34
36		170	166	160	154	147	136	122	108	97.0	85.5	76.3	67.1	36
38		158	154	149	144	138	132	120	107	96.4	85.1	76.1	67.0	38
40			142	139	136	131	125	119	106	95.6	84.6	75.7	66.7	40
44			122	121	118	116	112	107	102	93.6	83.2	74.8	66.1	44
48				104	103	102	100	97.3	93.0	88.9	81.5	73.7	65.2	48
52					91.1	90.1	88.3	86.6	84.0	81.1	77.4	72.2	64.1	52
56					78.9	79.3	78.4	77.6	75.4	73.4	70.7	67.9	62.8	56
60						69.5	69.1	69.1	67.6	66.0	64.3	62.4	59.8	60
64							61.5	61.5	60.2	59.7	58.3	56.7	55.0	64
68								54.5	53.7	53.3	52.5	51.8	50.0	68
72								48.4	48.0	48.2	47.3	46.8	45.6	72
76									43.0	43.2	42.8	42.3	41.6	76
80										38.5	38.4	38.3	37.7	80
84										34.3	34.7	34.5	34.2	84
88											31.1	31.2	30.9	88
92												28.0	27.9	92
96												25.2	25.2	96
100													22.8	100

Load chart of ZLJDB configuration

Note:

1. Meet ISO 4305 standard;
2. The rated load in the table includes the weight of hook, wire rope and other spreader. The weight to be lifted is the sum of the rated load minus the weight of the above items.

ZLJDB Load Chart - 8/9
(Boom angle 85°, Jib length 24~96m, Superlift radius 22m, Superlift counterweight 390t,
Rear counterweight 230t, Carbody counterweight 80t)

Boom length 90m														
Radius (m)	24	30	36	42	48	54	60	66	72	78	84	90	96	Radius (m)
18	277													18
19	274													19
20	270	239												20
22	262	234	209											22
24	254	229	206	183	163									24
26	244	222	201	180	161	143								26
28	227	215	196	177	159	142	127							28
30	210	200	190	173	157	140	126	112						30
32	195	186	178	169	154	139	124	111	98.9	87.6				32
34		171	166	159	150	136	123	110	98.2	87.3	77.1			34
36		160	154	149	142	134	121	109	97.4	86.7	76.8	68.6		36
38		148	143	139	134	128	119	107	96.4	86.1	76.4	68.3	60.1	38
40			134	130	126	121	115	106	95.2	85.3	75.8	68.0	59.9	40
44			115	113	110	108	103	99.6	92.6	83.3	74.4	67.0	59.2	44
48				98.8	97.1	95.7	92.3	89.8	85.8	81.1	72.8	65.7	58.3	48
52					85.1	83.9	82.1	80.6	77.6	74.6	70.8	64.3	57.2	52
56					74.3	74.2	73.0	71.8	69.7	67.5	65.0	62.3	55.9	56
60						65.3	64.8	64.0	62.1	61.1	58.9	57.3	54.5	60
64							57.0	57.2	55.5	54.9	53.4	52.0	50.1	64
68							50.3	50.8	50.0	49.1	48.1	47.2	45.8	68
72								44.9	44.5	44.3	43.5	42.9	41.7	72
76									39.7	39.5	39.1	38.8	38.0	76
80									35.2	35.3	35.1	34.8	34.1	80
84										31.7	31.4	31.4	31.0	84
88											28.5	28.4	27.9	88
92												25.6	25.4	92
96												22.9	22.9	96
100													20.5	100

Unit: t

Load chart of ZLJDB configuration

Note:

1. Meet ISO 4305 standard;
2. The rated load in the table includes the weight of hook, wire rope and other spreader. The weight to be lifted is the sum of the rated load minus the weight of the above items.

ZLJDB Load Chart - 9/9 (Boom angle 85°, Jib length 24~96m, Superlift radius 22m, Superlift counterweight 390t, Rear counterweight 230t, Carbody counterweight 80t)														
Boom length 96m														
Radius (m)	24	30	36	42	48	54	60	66	72	78	84	90	96	Radius (m)
19	253													19
20	253	224												20
22	246	220	197											22
24	238	215	194	173										24
26	229	209	189	170	153									26
28	219	202	185	167	151	135	120							28
30	203	193	180	163	148	133	119	106						30
32	188	179	172	160	145	131	118	106	93.8					32
34	175	167	160	153	142	129	116	105	93.1	83.0	73.3			34
36		155	149	144	138	127	114	103	92.2	82.5	73.0	65.3		36
38		143	139	135	129	123	112	102	91.2	81.8	72.5	65.1	57.1	38
40			129	125	121	117	110	100	90.0	80.9	71.9	64.7	56.9	40
44			112	110	107	104	100	96.3	87.3	79.0	70.5	63.7	56.2	44
48				96.1	94.3	92.3	89.0	86.5	82.7	76.7	68.7	62.4	55.2	48
52					82.8	81.6	79.7	77.6	74.7	71.7	66.8	60.8	54.0	52
56					72.4	71.7	70.5	69.1	67.1	64.9	62.3	59.1	52.7	56
60						63.2	62.4	61.6	59.8	58.6	56.8	55.1	51.3	60
64							55.4	55.1	53.7	52.7	51.4	49.9	47.9	64
68							48.6	49.0	48.0	47.2	46.3	45.2	43.7	68
72								43.5	42.7	42.6	41.7	41.1	39.6	72
76									38.1	37.9	37.4	36.9	36.2	76
80									34.0	33.9	33.7	33.3	32.6	80
84										30.4	30.2	30.0	29.5	84
88											27.1	26.9	26.6	88
92											24.3	24.2	23.9	92
96												21.7	21.5	96
100													19.3	100

Boom combination in H

Boom combination in H					
Boom length (m)	Insert				
	3m	6m	12mB	12mC	12mD
24	-	-	-	-	-
30	-	1	-	-	-
36	-	-	1	-	-
42	-	1	1	-	-
48	-	-	2	-	-
54	-	1	2	-	-
60	-	2	2	-	-
66	-	1	2	1	-
72	-	2	2	1	-
78	-	1	2	2	-
84	-	2	2	2	-
90	-	1	2	2	1
96	-	2	2	2	1
99	1	2	2	2	1

Note: The 24 m basic boom is composed of 10.5 m boom base, 12 m boom transition section and boom connecting tip.

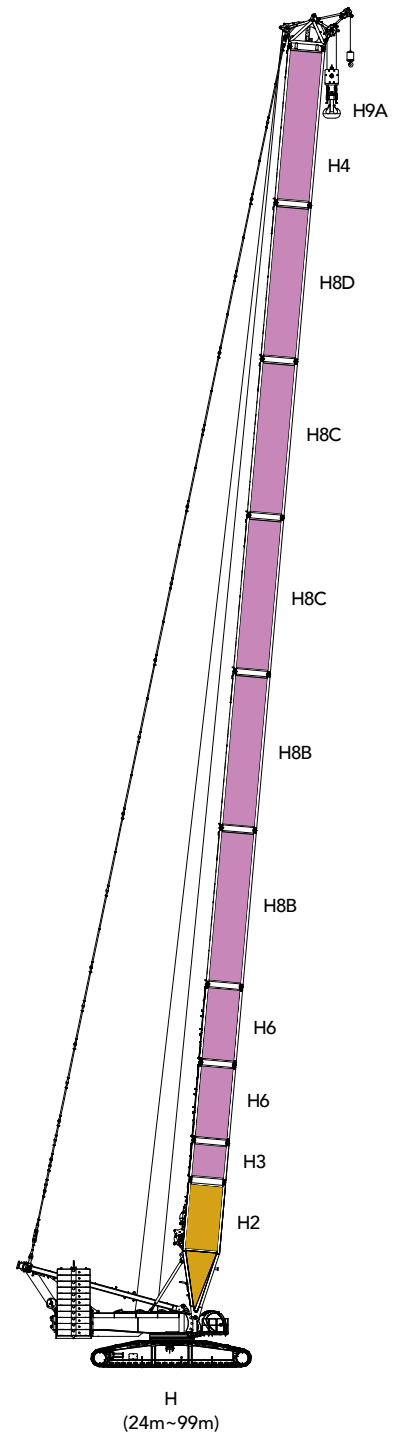

H working radius diagram

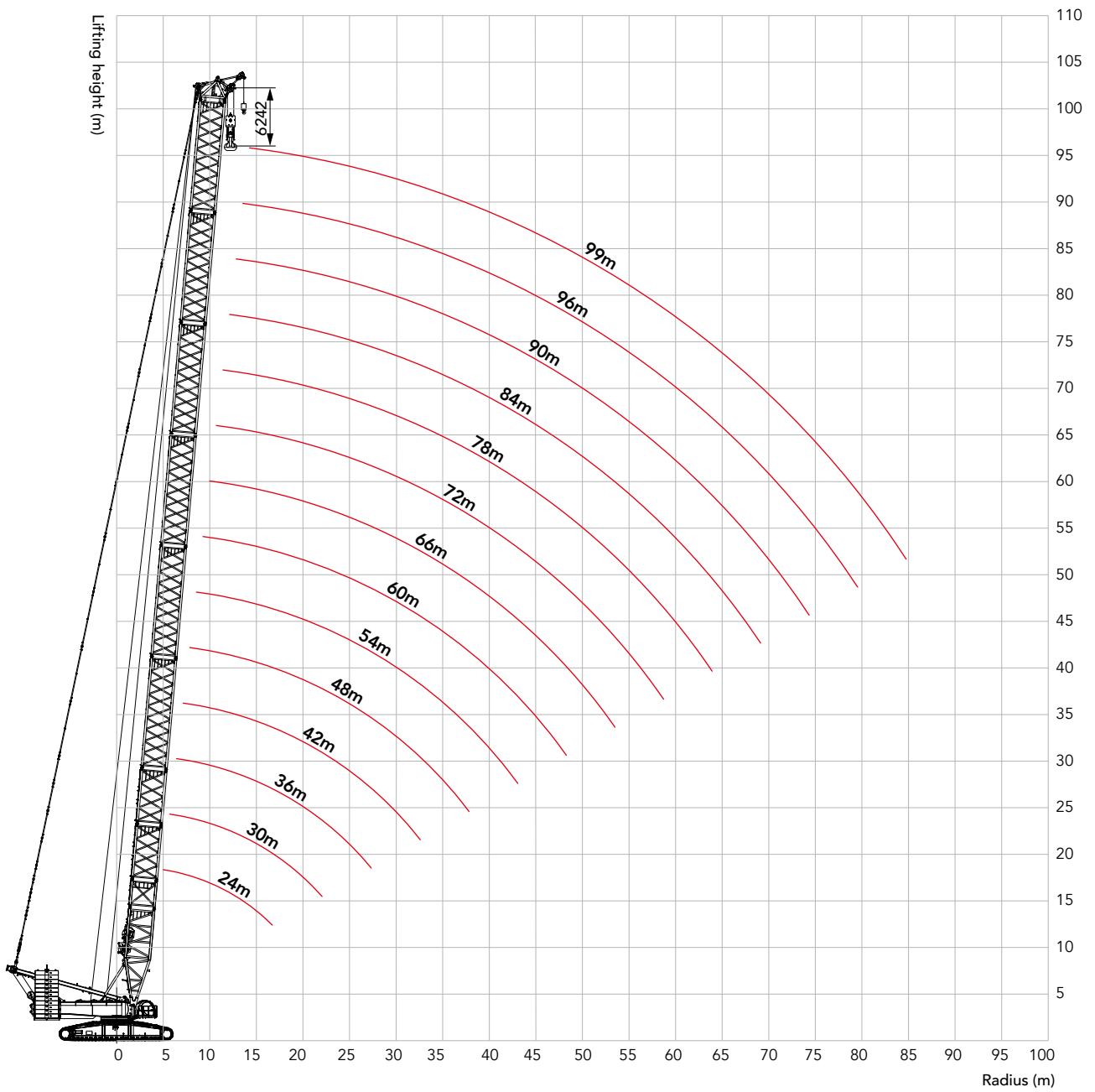

Load chart of H configuration

Note:

1. Meet ISO 4305 standard;
2. The rated load in the table includes the weight of hook, wire rope and other spreader. The weight to be lifted is the sum of the rated load minus the weight of the above items.

H Load Charts
(Boom length 24~99m, Rear counterweight 230t, Carbody counterweight 80t)

Radius (m)	24	30	36	42	48	54	60	66	72	78	84	90	96	99	Radius (m)
6	800														6
7	708	701	694												7
8	605	600	595	589	584										8
9	528	524	520	515	508	481	456								9
10	468	465	461	457	449	427	406	388	370						10
11	419	417	414	410	401	382	365	350	335	322	308				11
12	379	377	375	372	361	346	332	319	306	294	282	272	261		12
14	317	316	314	312	301	290	279	269	259	250	240	232	224	220	14
16	272	271	270	266	257	248	239	231	223	216	208	201	194	191	16
18	236	236	235	231	223	215	208	202	195	189	182	177	171	167	18
20	202	203	204	203	196	190	183	178	172	167	161	156	151	148	20
22	175	177	177	177	174	169	163	159	153	149	144	140	135	132	22
24		155	156	155	155	152	147	142	138	134	129	125	121	119	24
26		138	138	138	137	137	132	129	124	121	116	113	109	107	26
28		123	124	124	123	122	120	117	113	109	106	103	99.1	97.2	28
30			112	111	111	110	109	107	103	100	96.5	93.8	90.1	88.3	30
32			101	101	100	99.8	98.6	98	94.6	91.6	88.1	85.6	82.1	80.3	32
34				92.4	91.8	90.8	89.6	88.9	86.8	84	80.7	78.3	75	73.3	34
36				84.4	83.9	82.9	81.6	81	79.6	77.3	74	71.8	68.6	67	36
38				77.3	76.9	75.9	74.6	74	72.6	71.2	68	65.9	62.8	61.3	38
40					70.6	69.7	68.4	67.8	66.4	65.5	62.6	60.6	57.6	56.1	40
44					60	59.1	57.9	57.3	55.8	54.9	53.3	51.4	48.6	47.1	44
48						50.4	49.2	48.6	47.2	46.2	44.7	43.7	40.9	39.5	48
52							41.9	41.4	39.9	39	37.4	36.7	34.4	33	52
56								35.2	33.8	32.9	31.3	30.6	28.7	27.4	56
60									28.5	27.6	26.1	25.4	23.7	22.5	60
64									23.9	23.1	21.5	20.8	19.1	18.2	64
68										19	17.5	16.8	15.1	14.3	68
72											13.9	13.2	11.6	10.7	72
76												10.1	8.4	7.6	76
80													7.2	5.6	80

Boom combination in HDB

Boom combination in HDB						
Boom length (m)	Insert					
	3m	6m	12mB	12mC	12mD	12mE
42	-	1	1	-	-	-
48	-	2	1	-	-	-
54	-	1	2	-	-	-
60	-	2	2	-	-	-
66	-	1	2	1	-	-
72	-	2	2	1	-	-
78	-	1	2	2	-	-
84	-	2	2	2	-	-
90	-	1	2	2	1	-
96	-	2	2	2	1	-
102	-	1	2	2	1	1
108	-	2	2	2	1	1
111	1	2	2	2	1	1

Note: The 10.5 m boom base, 12 m boom transition section and boom connecting tip are must.

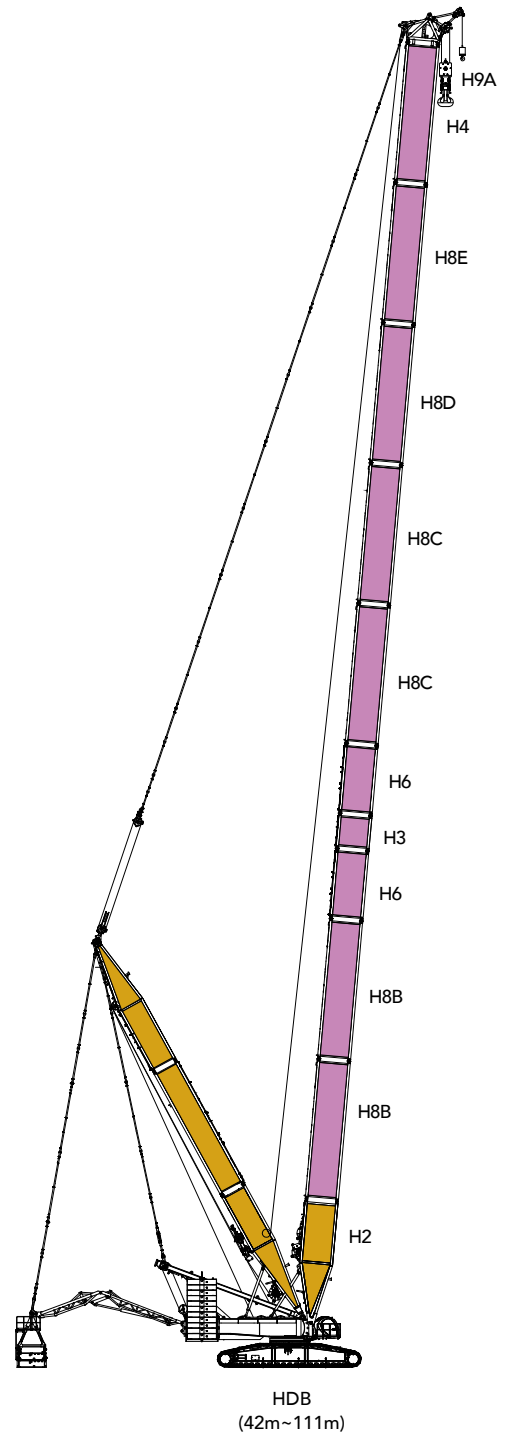

HDB working radius diagram

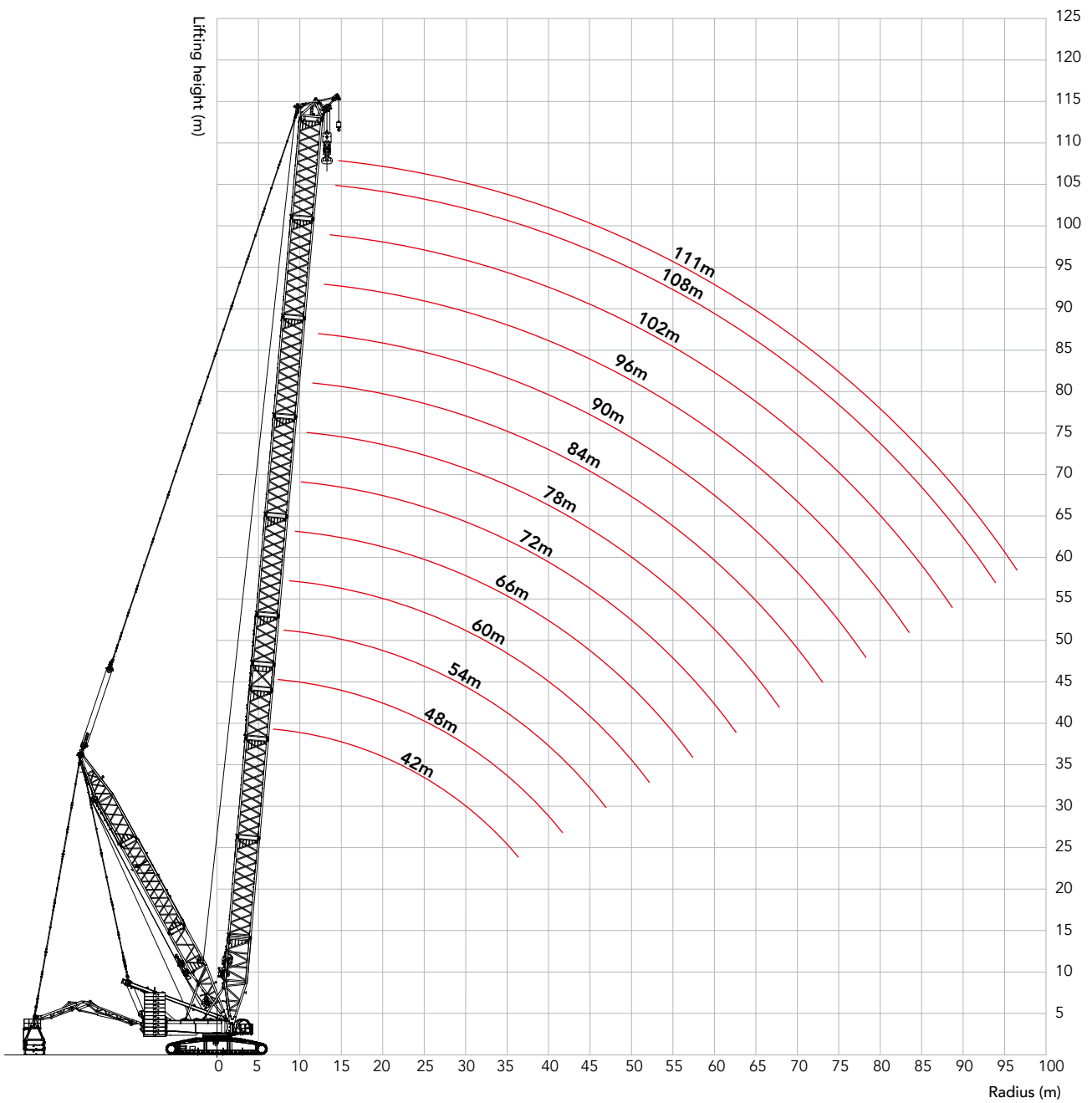

Unit: t

Load chart of HDB configuration

Note:

1. Meet ISO 4305 standard;
2. The rated load in the table includes the weight of hook, wire rope and other spreader. The weight to be lifted is the sum of the rated load minus the weight of the above items.

HDB Load Charts (Boom length 42~111m, Superlift Radius 22m, Superlift CWT 390t, Rear CWT 230t, Carbody CWT 80t)														
Radius (m)	42	48	54	60	66	72	78	84	90	96	102	108	111	Radius (m)
8	800	792												8
9	800	791	776	754										9
10	800	796	780	758	681	577								10
11	800	800	784	760	683	578	485	419						11
12	800	800	787	768	685	580	485	419	354	311				12
14	797	800	797	775	691	581	486	420	356	311	264	236	222	14
16	675	751	688	669	647	585	489	422	356	312	265	235	223	16
18	614	634	634	588	571	550	492	422	357	313	265	235	222	18
20	538	559	562	524	510	493	476	423	358	314	265	235	222	20
22	476	527	503	498	461	447	432	417	356	312	266	235	222	22
24	450	473	455	452	420	408	396	382	357	312	265	236	223	24
26	404	428	414	413	407	376	365	352	357	312	265	235	222	26
28	364	389	400	379	375	367	338	327	336	312	265	235	222	28
30	350	377	368	350	348	341	315	305	313	303	264	234	221	30
32	318	345	339	344	323	318	311	285	294	284	264	234	219	32
34	288	316	313	319	302	297	292	268	276	268	260	232	217	34
36	278	310	308	297	299	279	274	267	261	253	246	230	215	36
38	251	285	286	277	281	262	259	252	247	239	233	225	213	38
40		261	265	275	263	262	244	239	249	227	221	214	210	40
44		234	243	241	233	234	219	215	225	219	200	194	191	44
48			223	225	220	209	210	194	204	199	195	177	174	48
52				196	195	200	189	188	186	182	179	174	160	52
56					184	179	183	171	181	167	165	160	158	56
60						170	165	167	166	164	152	148	146	60
64						152	156	152	153	151	151	137	135	64
68							144	138	142	140	140	137	125	68
72								133	132	130	129	127	125	72
76									123	121	121	118	117	76
80									115	113	113	111	108	80
84										106	105	103	102	84
88											98.5	96.6	95.5	88
92												90.5	89.4	92
96												84.9	83.8	96

Boom combination in HJ

Boom combination in HJ

Boom length (m)	Boom insert						Jib insert	
	3m	6m	12mB	12mC	12mD	12mE	6m	12mA
84	-	2	2	1	-	-	-	1
90	-	1	2	2	-	-	-	1
96	-	2	2	2	-	-	-	1
102	-	1	2	2	1	-	-	1
108	-	-	2	2	1	1	-	1
114	-	-	2	2	1	1	1	1
120	-	1	2	2	1	1	1	1
123	1	1	2	2	1	1	1	1

Note: The 10.5 m boom base, 6 m tapered section and 7.5 m jib top are must.

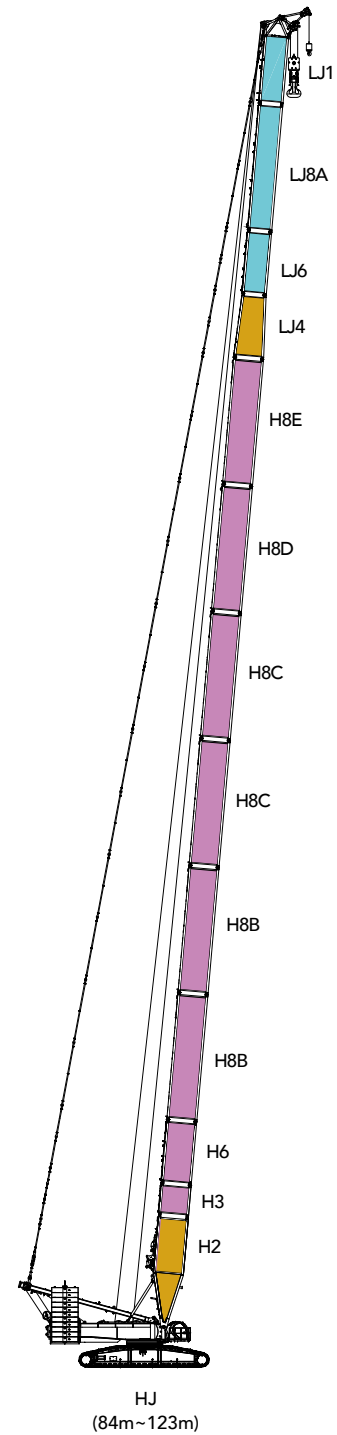

HJ working radius diagram

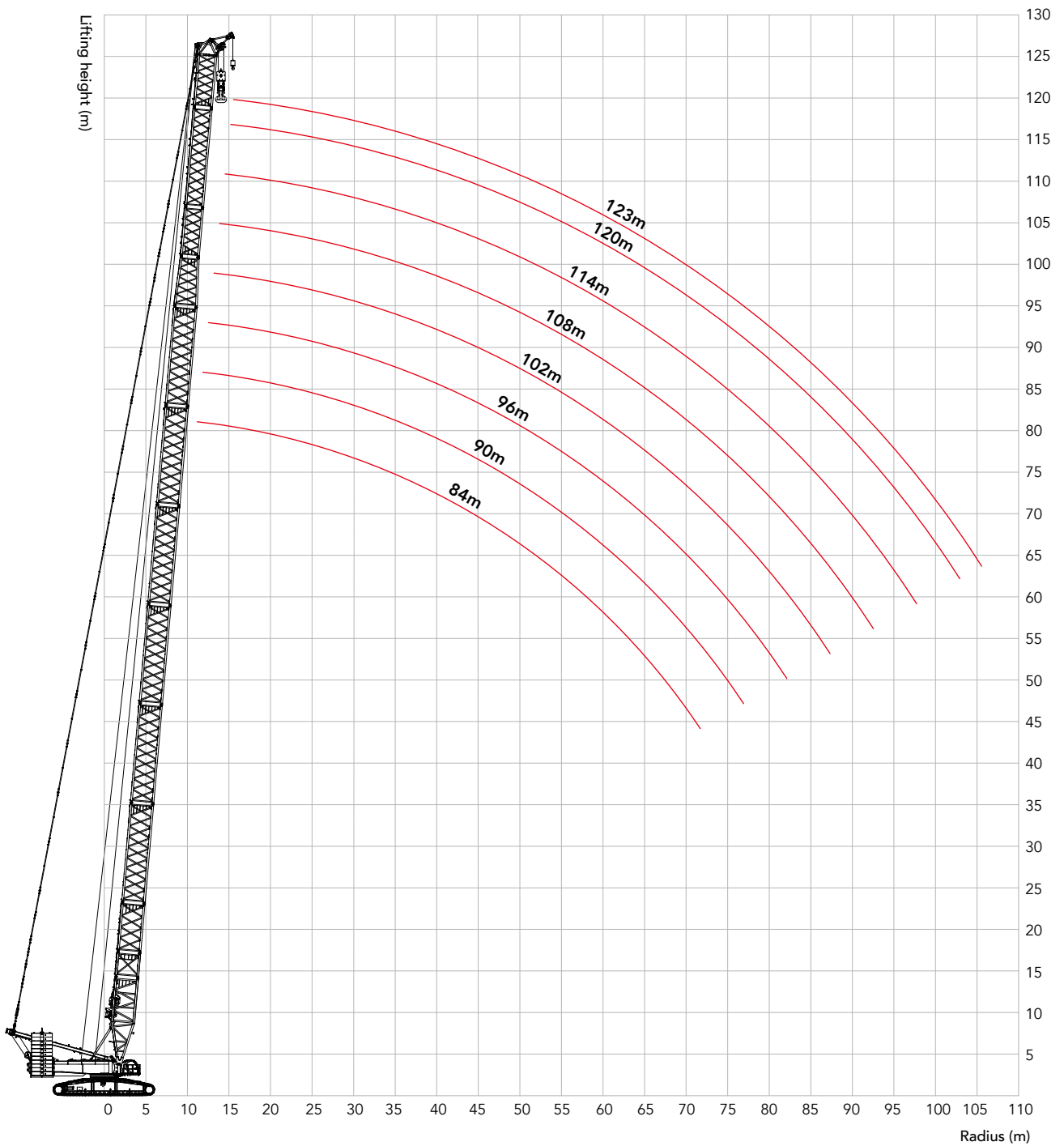

Load chart of HJ configuration

Note:

1. Meet ISO 4305 standard;
2. The rated load in the table includes the weight of hook, wire rope and other spreader. The weight to be lifted is the sum of the rated load minus the weight of the above items.

HJ Load Charts (Boom length 84~123m, Rear counterweight 230t, Carbody counterweight 80t)									
Radius (m)	84	90	96	102	108	114	120	123	Radius (m)
11	316								11
12	291	280	269						12
14	249	241	232	222	187	162	144		14
16	217	210	203	197	180	156	139	131	16
18	191	185	179	174	169	151	134	126	18
20	170	165	160	155	151	146	129	121	20
22	153	148	144	140	136	132	124	116	22
24	138	134	130	126	123	120	116	112	24
26	126	122	118	115	112	109	105	103	26
28	115	112	108	105	102	99.7	96.2	94.3	28
30	106	102	99.2	96.5	94.1	91.4	88	86.3	30
32	97.6	94.7	91.3	88.7	86.5	84	80.7	79.1	32
34	90.2	87.5	84.2	81.8	79.7	77.3	74.2	72.6	34
36	83.6	81	77.8	75.6	73.6	71.3	68.3	66.8	36
38	77.7	75.2	72.1	70	68.1	65.9	63	61.5	38
40	72.3	69.9	67	64.9	63.1	61	58.2	56.7	40
44	61.9	60.8	57.9	56	54.4	52.4	49.7	48.3	44
48	53.3	52.2	50.3	48.5	47	45.2	42.6	41.2	48
52	46.1	45	43.4	42.1	40.7	39	36.4	35.1	52
56	40	38.9	37.3	36.5	35.3	33.6	31.1	29.8	56
60	34.8	33.7	32.1	31.2	30.5	28.9	26.4	25.2	60
64	30.2	29.2	27.5	26.7	26.1	24.7	22.3	21.1	64
68	26.3	25.2	23.6	22.7	22.1	21	18.6	17.4	68
72	22.7	21.7	20	19.2	18.6	17.7	15.4	14.2	72
76		18.5	16.9	16.1	15.5	14.5	12.4	11.2	76
80		15.7	14.1	13.3	12.7	11.7	9.7	8.5	80
84			11.5	10.7	10.1	9.2	7.3	6.1	84
88				8.4	7.8	6.9	5		88
92					5.7				92

Boom combination in HJDB

Boom combination in HJDB									
Boom length (m)	Boom insert						Jib insert		
	3m	6m	12mB	12mC	12mD	12mE	6m	12mA	12mB
90	-	1	2	2	-	-	-	1	-
96	-	2	2	2	-	-	-	1	-
102	-	1	2	2	1	-	-	1	-
108	-	2	2	2	1	-	-	1	-
114	-	1	2	2	1	1	-	1	-
120	-	1	2	2	1	1	1	1	-
126	-	1	2	2	1	1	-	1	1
132	-	1	2	2	1	1	1	1	1
138	-	2	2	2	1	1	1	1	1
144	-	2	2	2	1	1	2	1	1
147	1	2	2	2	1	1	2	1	1

Note: The 10.5 m boom base, 6 m tapered section and 7.5 m jib top are must.
The mid-point suspension cable must be used for the boom length of 120m-147m in this working condition, otherwise, the boom system may be broken.

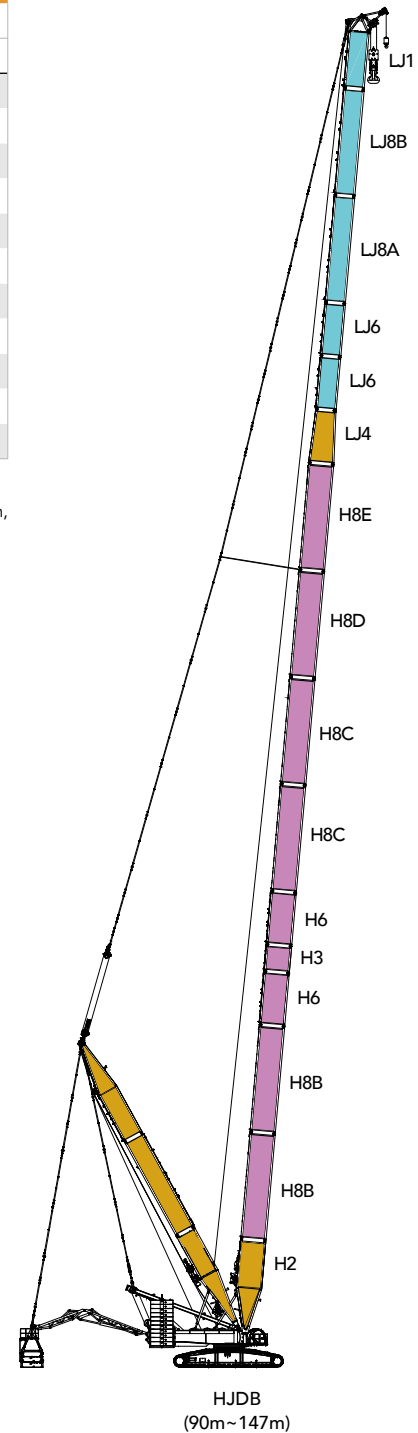

HJDB working radius diagram

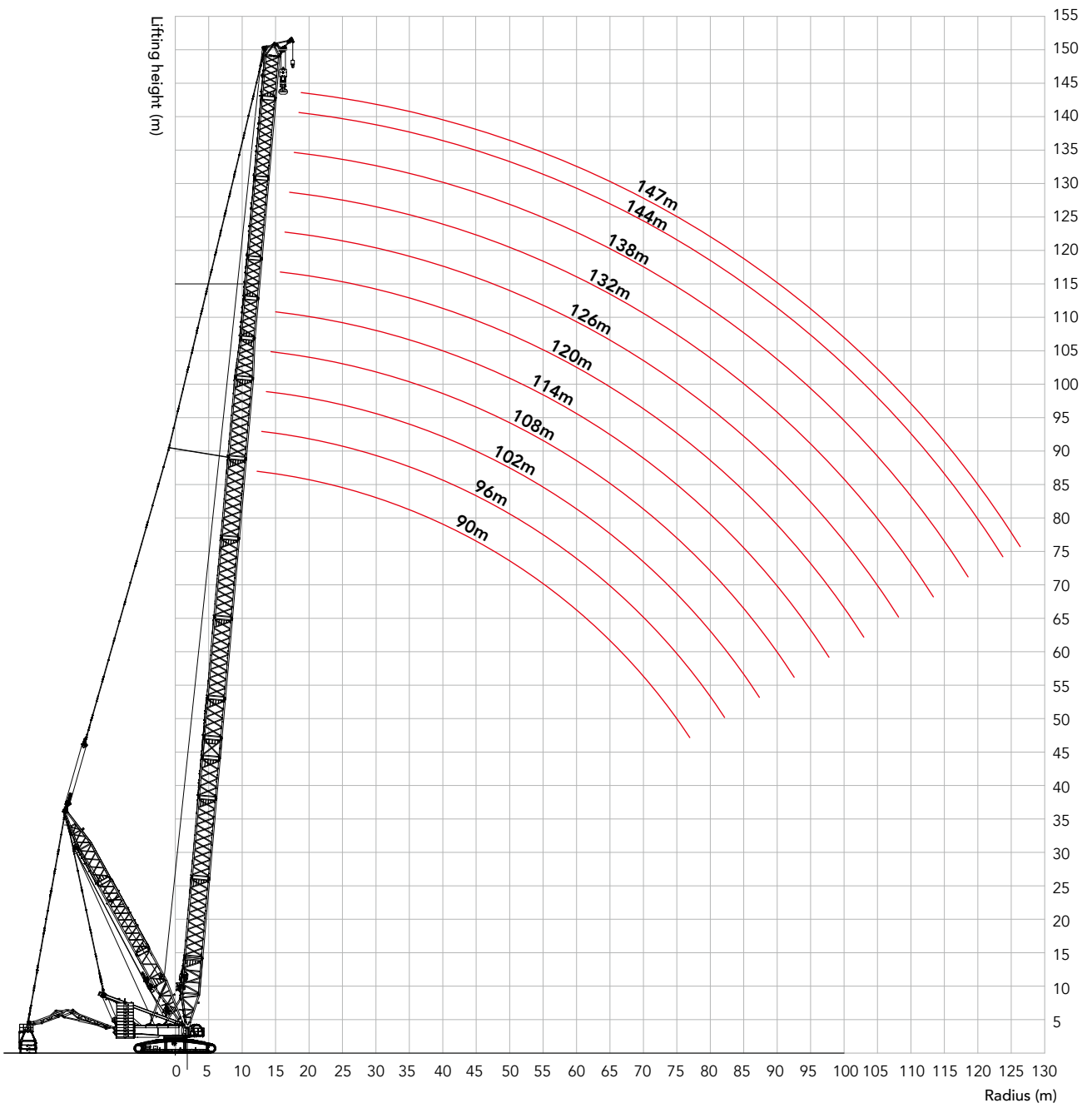

Unit: t

Load chart of HJDB configuration

Note:

1. Meet ISO 4305 standard;
2. The rated load in the table includes the weight of hook, wire rope and other spreader. The weight to be lifted is the sum of the rated load minus the weight of the above items.

HJDB Load Charts (Boom length 90~147m, Superlift Radius 22m, Superlift CWT 390t, Rear CWT 230t, Carbody CWT 80t)												
Radius (m)	90	96	102	108	114	120	126	132	138	144	147	Radius (m)
14	344	309	266									14
16	346	310	266	239	204	178						16
18	348	310	266	239	204	178	155	133	122			18
20	349	310	266	239	204	179	154	132	121	104	98.8	20
22	350	310	266	238	205	178	153	131	120	103	98.0	22
24	322	310	265	238	204	177	152	130	118	101	97.0	24
26	297	305	266	237	203	176	151	129	117	100	96.1	26
28	277	284	259	237	202	175	150	128	116	99.4	95.1	28
30	258	266	242	236	200	174	148	127	115	98.4	94.1	30
32	243	249	228	234	198	172	147	125	114	97.4	93.2	32
34	228	235	215	221	196	171	146	124	113	96.5	92.3	34
36	216	222	203	209	194	170	145	123	112	95.8	91.4	36
38	217	211	192	198	192	169	144	122	111	94.8	90.5	38
40	206	200	183	188	184	168	143	121	110	93.9	89.6	40
44	187	194	166	171	167	163	140	119	108	92.0	87.8	44
48	170	177	162	157	153	149	138	116	107	90.2	86.1	48
52	155	163	149	155	141	137	134	114	105	88.4	84.4	52
56	152	150	137	143	140	127	124	112	103	86.7	82.8	56
60	140	149	127	132	130	127	115	110	101	85.0	81.2	60
64	129	137	126	123	120	118	116	108	99.3	83.3	79.6	64
68	127	127	117	117	108	110	108	105	97.5	81.6	78.1	68
72	117	120	108	105	98.2	103	101	99.2	95.6	80.0	76.5	72
76	114	108	104	94.6	88.8	105	95.5	93.1	89.8	78.4	75.0	76
80	99.6	94.2	91.6	84.0	79.7	98.7	97.4	87.5	84.4	76.9	73.7	80
84		83.1	81.3	74.7	71.1	92.5	91.5	89.6	79.3	75.3	72.3	84
88			71.1	65.8	62.7	86.7	86.0	84.4	74.6	72.6	70.9	88
92				57.1	54.6	88.8	80.7	79.4	76.9	68.3	66.8	92
96					48.1	83.0	83.1	74.7	72.4	70.8	68.0	96
100					40.6	77.3	77.9	77.2	68.2	66.7	65.4	100
104						79.3	72.8	72.5	64.0	62.8	61.6	104
108							75.1	67.9	66.6	59.0	57.9	108
112								63.4	62.4	61.7	60.7	112
116								65.6	58.3	57.9	57.0	116
120									60.8	54.1	53.4	120
124										56.8	49.8	124
128											52.5	128

Boom combination in HJFJ

Boom combination in HJFJ

Boom length (m)	Boom insert						Jib insert		
	3m	6m	12mB	12mC	12mD	12mE	6m	12mA	
84	-	2	2	1	-	-	-	1	Fixed jib 12 m
90	-	1	2	2	-	-	-	1	
96	-	2	2	2	-	-	-	1	
102	-	1	2	2	1	-	-	1	
108	-	-	2	2	1	1	-	1	
114	-	-	2	2	1	1	1	1	
120	-	1	2	2	1	1	1	1	

Note: The 10.5 m boom base section, 6 m tapered section and 7.5 m jib top are must.

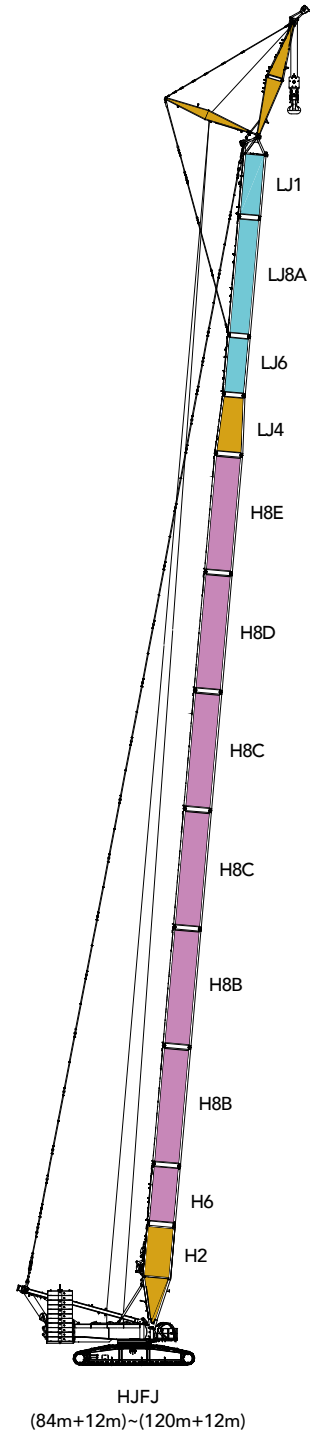

HJFJ working radius diagram

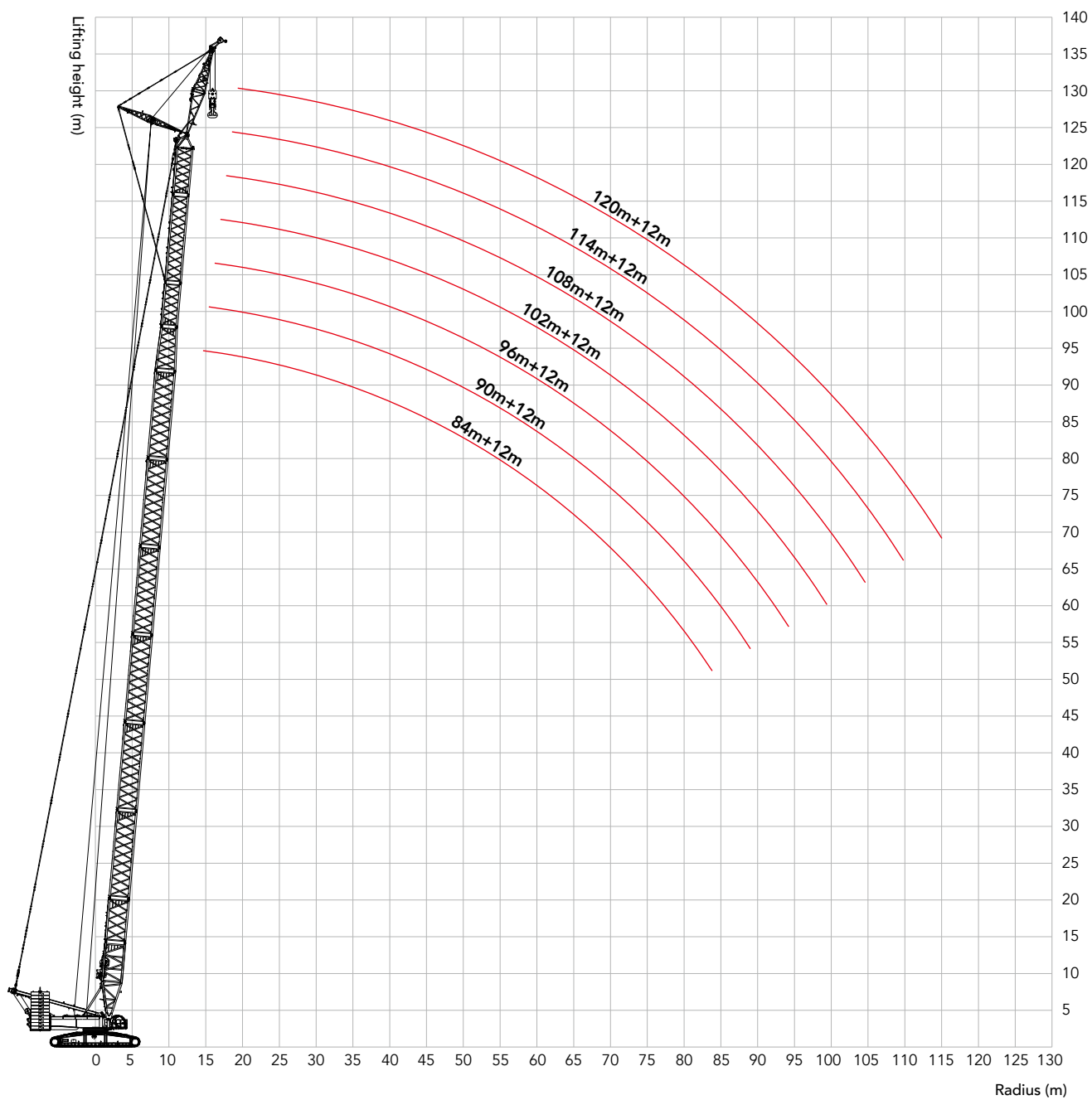

Load chart of HJFJ configuration

Note:

1. Meet ISO 4305 standard;
2. The rated load in the table includes the weight of hook, wire rope and other spreader. The weight to be lifted is the sum of the rated load minus the weight of the above items.

HJFJ Load Charts (Boom length 84~120m, Jib length 12m, Boom to jib angle 15°, Rear counterweight 230t, Carbody counterweight 80t)								
Radius (m)	84	90	96	102	108	114	120	Radius (m)
14	174							14
16	171	165	160	158	136			16
18	167	162	156	155	132	114	98.8	18
20	164	159	153	151	129	111	95.9	20
22	149	145	141	137	125	108	92.9	22
24	136	132	128	124	121	105	89.9	24
26	124	120	116	113	110	102	87.1	26
28	113	110	106	103	101	98.4	84.3	28
30	104	101	98.1	95.4	93	90.3	81.6	30
32	96.5	93.6	90.4	87.8	85.6	83.1	78.9	32
34	89.3	86.6	83.5	81.1	79	76.6	73.6	34
36	82.9	80.3	77.3	75	73	70.8	67.9	36
38	77.1	74.6	71.7	69.5	67.6	65.5	62.7	38
40	71.9	69.5	66.6	64.5	62.7	60.6	57.9	40
44	62.7	60.5	57.8	55.8	54.1	52.2	49.6	44
48	55	52.9	50.3	48.4	46.9	45	42.5	48
52	47.8	46.4	43.9	42.1	40.6	38.9	36.4	52
56	41.7	40.5	38.3	36.6	35.2	33.5	31.1	56
60	36.3	35.2	33.5	31.8	30.5	28.8	26.5	60
64	31.7	30.6	29	27.6	26.3	24.7	22.4	64
68	27.7	26.6	25	23.8	22.6	21	18.7	68
72	24.1	23	21.4	20.4	19.2	17.7	15.4	72
76	20.9	19.8	18.2	17.3	16.2	14.7	12.4	76
80	18.1	17	15.4	14.5	13.5	12	9.7	80
84	15.4	14.4	12.8	11.9	11	9.5	7.3	84
88		12	10.4	9.5	8.7	7.2	5	88
92		9.8	8.3	7.4	6.6	5.1		92
96			6.3	5.4				96

Boom combination in LJ

Boom combination in LJ			
Boom length(m)	Boom insert	Jib insert	
	12m	6m	12m
24	-	-	-
30	-	1	-
36	1	-	-
42	1	1	-
48	1	2	-
54	1	1	1
60	1	2	1
66	1	1	2
72	1	2	2
78	1	1	3
84	1	2	3
90*	1	1	4
96*	1	2	4

Note:

The boom is the same as H Configuration;

jib base, 6m tapered section and Jib top are must.

The mid-point suspension cable must be used for the boom length with the symbol "*" in this working condition, otherwise, the boom system may be broken.

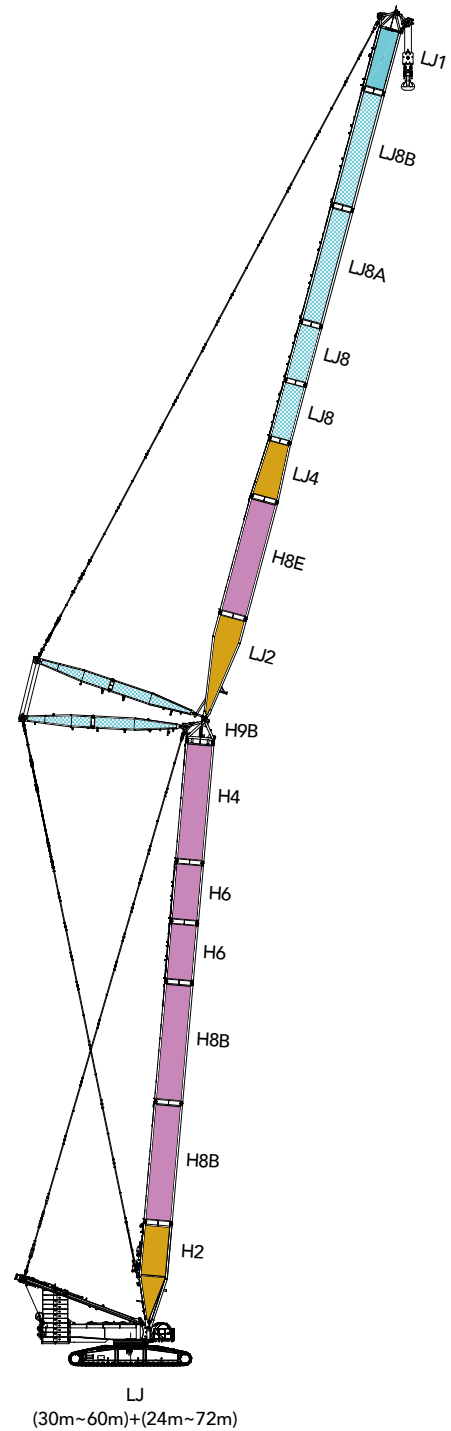

LJ working radius diagram

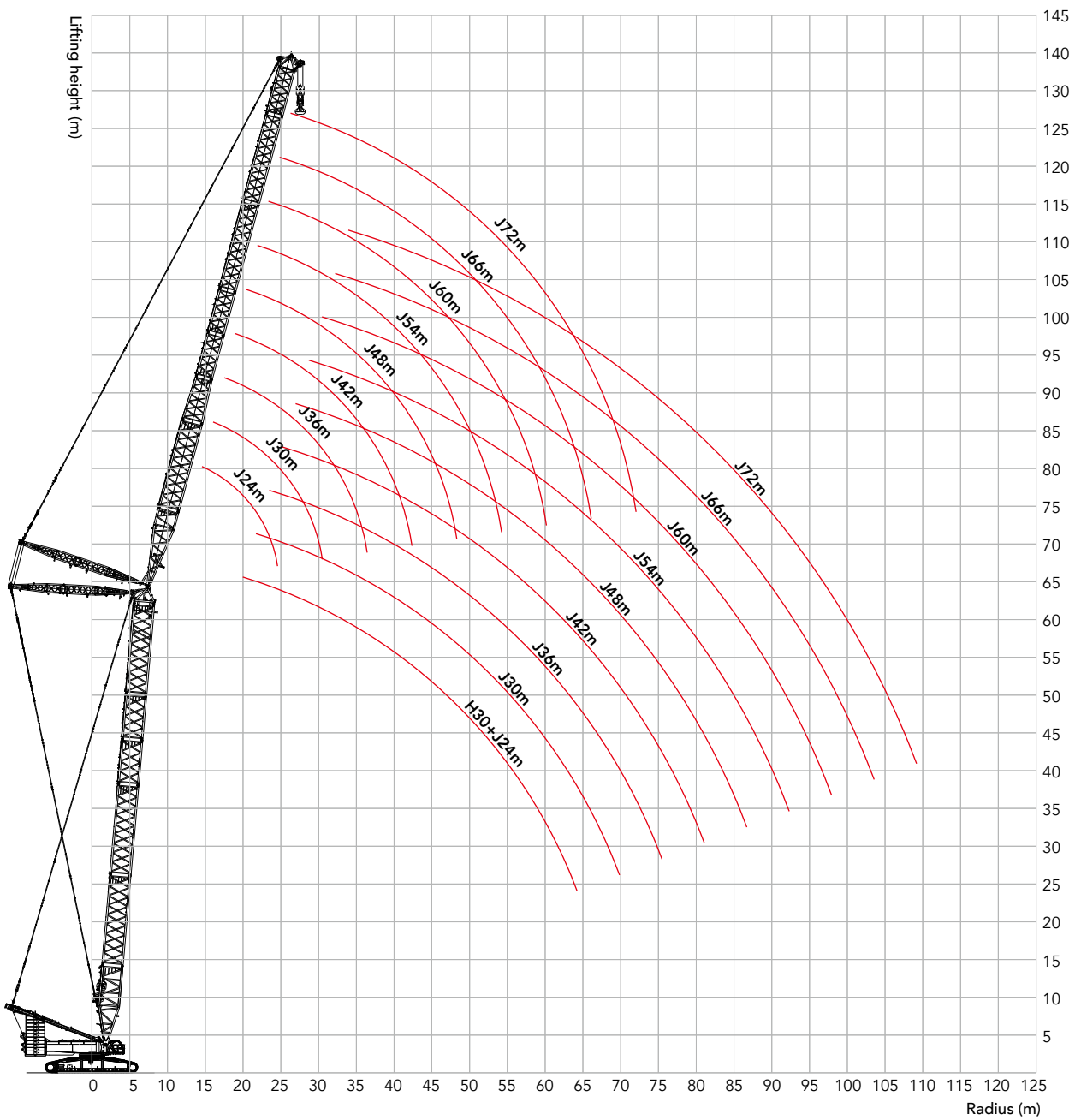

Unit: t

Load chart of LJ configuration

Note:

1. Meet ISO 4305 standard;
2. The rated load in the table includes the weight of hook, wire rope and other spreader. The weight to be lifted is the sum of the rated load minus the weight of the above items.

LJ Load Charts - 1/6 (Boom angle 85°, Jib length 24~96m, Rear counterweight 230t, Carbody counterweight 80t)														
Boom length 30m														
Radius(m)	24	30	36	42	48	54	60	66	72	78	84	90	96	Radius(m)
16	272													16
18	240	232												18
20	214	208	201											20
22	194	188	182	177										22
24	176	171	166	161	156									24
26	161	157	152	148	144	140								26
28	145	145	140	136	133	129	126							28
30		133	130	127	123	120	117	114						30
32		122	121	118	115	112	109	106	103					32
34			112	110	107	104	101	99.5	96.6	94.3				34
36			103	103	100	98.3	95.4	93.2	90.4	88.3	85.5			36
38			96.2	95.9	94.7	92.4	89.6	87.6	84.9	82.8	80.2	78.1		38
40				89.4	88.6	87.1	84.4	82.5	79.9	77.9	75.4	73.4	70.9	40
44				78.1	77.6	77.2	75.3	73.5	71.1	69.3	66.9	65.1	62.7	44
48					68.5	68.2	67.2	66	63.7	62	59.7	58	55.8	48
52						60.6	59.7	59.3	57.4	55.8	53.6	52	49.9	52
56						54	53.3	52.9	51.9	50.4	48.3	46.7	44.7	56
60							47.7	47.5	46.4	45.7	43.6	42.1	40.1	60
64								42.7	41.7	41.1	39.5	38.1	36.1	64
68								38.4	37.5	37	35.9	34.5	32.6	68
72									33.7	33.3	32.2	31.2	29.4	72
76										30	28.9	28.3	26.5	76
80										26.9	26	25.4	23.9	80
84											23.3	22.7	21.5	84
88												20.2	19.2	88
92													17	92
96													14.9	96

Load chart of LJ configuration

Note:

1. Meet ISO 4305 standard;
2. The rated load in the table includes the weight of hook, wire rope and other spreader. The weight to be lifted is the sum of the rated load minus the weight of the above items.

LJ Load Charts - 2/6 (Boom angle 85°, Jib length 24~96m, Rear counterweight 230t, Carbody counterweight 80t)														
Boom length 36m														
Radius(m)	24	30	36	42	48	54	60	66	72	78	84	90	96	Radius(m)
16	262													16
18	232	224												18
20	207	201	195											20
22	188	182	176	171										22
24	171	166	161	156	152									24
26	157	153	148	144	140	136								26
28	145	141	137	133	129	126	122							28
30		131	127	123	120	117	113	111						30
32		122	118	115	111	109	106	103	100					32
34		112	111	107	104	102	99.1	96.8	93.9	91.6				34
36			103	101	98.2	95.8	92.9	90.7	87.9	85.8	83			36
38			96.1	95.3	92.4	90.1	87.3	85.3	82.6	80.5	77.9	75.8		38
40			89.3	89.1	87.1	84.9	82.2	80.3	77.7	75.7	73.2	71.2	68.7	40
44				78	77.4	75.9	73.4	71.6	69.2	67.4	65	63.2	60.8	44
48					68.3	67.9	65.9	64.3	62	60.3	58	56.3	54.1	48
52						60.4	59.5	58.1	55.8	54.2	52.1	50.4	48.3	52
56							53.9	53.1	52.6	50.5	49	46.9	45.3	56
60								47.6	47.3	45.8	44.4	42.3	40.9	60
64									42.5	41.5	40.3	38.3	36.9	64
68										38.2	37.3	36.7	34.8	68
72											33.6	33.1	31.6	72
76												29.8	28.7	76
80													26.8	80
84														84
88														88
92														92
96														96

Unit: t

Load chart of LJ configuration

Note:

1. Meet ISO 4305 standard;
2. The rated load in the table includes the weight of hook, wire rope and other spreader. The weight to be lifted is the sum of the rated load minus the weight of the above items.

LJ Load Charts - 3/6 (Boom angle 85°, Jib length 24~96m, Rear counterweight 230t, Carbody counterweight 80t)														
Boom length 42m														
Radius(m)	24	30	36	42	48	54	60	66	72	78	84	90	96	Radius(m)
16	252													16
18	224	217												18
20	201	195	188											20
22	182	176	171	166										22
24	166	161	156	152	147									24
26	153	148	144	139	135	132								26
28	141	137	133	129	125	122	118							28
30		128	123	120	116	113	110	107						30
32		119	115	112	108	106	103	100	97.5					32
34		112	108	105	101	99.3	96.3	94	91.1					34
36			101	98.6	95.6	93.2	90.3	88.2	85.3	83.2				36
38			95.8	92.8	89.9	87.6	84.9	82.9	80.2	78.1	75.5			38
40			89.1	87.6	84.8	82.6	80	78	75.4	73.5	71	69		40
44				77.7	75.9	73.9	71.4	69.6	67.2	65.4	63	61.2	58.8	44
48					68	66.5	64.2	62.5	60.2	58.5	56.2	54.5	52.3	48
52					60.3	60.1	58	56.4	54.2	52.6	50.4	48.8	46.7	52
56						53.7	52.6	51.2	49	47.5	45.4	43.9	41.8	56
60							47.4	46.6	44.5	43	41	39.5	37.5	60
64								42.3	40.5	39.1	37.1	35.6	33.7	64
68								38	36.9	35.5	33.6	32.2	30.3	68
72									33.4	32.4	30.5	29.1	27.2	72
76										29.5	27.6	26.3	24.4	76
80										26.6	25.1	23.8	21.9	80
84											22.8	21.5	19.7	84
88												19.4	17.6	88
92												17.4	15.6	92
96													13.9	96

Load chart of LJ configuration

Note:

1. Meet ISO 4305 standard;
2. The rated load in the table includes the weight of hook, wire rope and other spreader. The weight to be lifted is the sum of the rated load minus the weight of the above items.

LJ Load Charts - 4/6 (Boom angle 85°, Jib length 24~96m, Rear counterweight 230t, Carbody counterweight 80t)														
Boom length 48m														
Radius(m)	24	30	36	42	48	54	60	66	72	78	84	90	96	Radius(m)
18	216													18
20	194	188												20
22	176	171	165											22
24	161	156	151	147										24
26	148	144	139	135	131									26
28	137	133	129	125	121	118								28
30		124	120	116	113	110	107							30
32		116	112	108	105	103	99.8	97.5						32
34		109	105	102	98.9	96.4	93.4	91.2	88.2					34
36			98.8	95.8	92.8	90.5	87.6	85.5	82.7	80.6				36
38			93.1	90.2	87.4	85.1	82.4	80.4	77.7	75.7	73			38
40			88	85.2	82.4	80.3	77.6	75.7	73.1	71.2	68.6	66.7		40
44				76.4	73.8	71.8	69.3	67.6	65.1	63.3	60.9	59.1	56.8	44
48					66.6	64.7	62.3	60.7	58.3	56.7	54.4	52.7	50.4	48
52					60.1	58.6	56.3	54.8	52.5	50.9	48.8	47.1	45	52
56						53.3	51.1	49.6	47.5	46	43.9	42.3	40.2	56
60							46.5	45.1	43.1	41.6	39.5	38.1	36	60
64							42.2	41.2	39.1	37.7	35.7	34.3	32.3	64
68								37.7	35.7	34.3	32.3	30.9	29	68
72									32.5	31.2	29.3	27.9	26	72
76										28.4	26.5	25.2	23.3	76
80										25.9	24	22.7	20.9	80
84											21.8	20.5	18.7	84
88												18.4	16.6	88
92												16.5	14.7	92
96													13	96

Unit: t

Load chart of LJ configuration

Note:

1. Meet ISO 4305 standard;
2. The rated load in the table includes the weight of hook, wire rope and other spreader. The weight to be lifted is the sum of the rated load minus the weight of the above items.

LJ Load Charts - 5/6 (Boom angle 85°, Jib length 24~96m, Rear counterweight 230t, Carbody counterweight 80t)														
Boom length 54m														
Radius(m)	24	30	36	42	48	54	60	66	72	78	84	90	96	Radius(m)
18	208													18
20	187	182												20
22	170	165	160											22
24	156	151	146	142										24
26	144	140	135	131	127									26
28	133	129	125	121	118	115								28
30	124	120	116	113	109	107	103							30
32		112	109	105	102	99.9	96.8	94.4						32
34		105	102	99.1	96	93.5	90.5	88.3	85.4					34
36			96.1	93.1	90.2	87.8	85	82.9	80.1	78				36
38			90.6	87.7	84.9	82.6	79.9	77.9	75.2	73.2	70.6			38
40			85.6	82.8	80.1	77.9	75.3	73.4	70.8	68.9	66.3	64.4		40
44				74.3	71.7	69.7	67.3	65.5	63.1	61.3	58.9	57.1	54.7	44
48					64.7	62.8	60.4	58.8	56.5	54.8	52.5	50.8	48.6	48
52					58.7	56.9	54.6	53.1	50.8	49.3	47.1	45.5	43.3	52
56						51.7	49.5	48.1	45.9	44.4	42.3	40.8	38.7	56
60							45.1	43.7	41.6	40.2	38.1	36.6	34.6	60
64							41.2	39.9	37.8	36.4	34.4	33	31	64
68								36.4	34.4	33.1	31.1	29.7	27.8	68
72									31.4	30.1	28.1	26.8	24.9	72
76									28.6	27.3	25.4	24.1	22.2	76
80										24.9	23	21.7	19.9	80
84											20.8	19.5	17.7	84
88											18.7	17.5	15.7	88
92												15.6	13.8	92
96													12.1	96

Load chart of LJ configuration

Note:

1. Meet ISO 4305 standard;
2. The rated load in the table includes the weight of hook, wire rope and other spreader. The weight to be lifted is the sum of the rated load minus the weight of the above items.

LJ Load Charts - 6/6 (Boom angle 85°, Jib length 24~96m, Rear counterweight 230t, Carbody counterweight 80t)										
Boom length 60m										
Radius(m)	24	30	36	42	48	54	60	66	72	Radius(m)
18	200									18
20	181	175								20
22	165	160	154							22
24	151	146	141	137						24
26	139	135	130	127	123					26
28	129	125	121	117	114	111				28
30	120	117	113	109	106	103	100			30
32		109	105	102	99.2	96.6	93.5	91.2		32
34		102	99	96	92.9	90.5	87.5	85.3	82.4	34
36		96.8	93.1	90.2	87.3	85	82.1	80.1	77.3	36
38			87.8	85	82.2	80	77.3	75.3	72.6	38
40			83	80.3	77.6	75.5	72.8	70.9	68.3	40
44				72	69.5	67.5	65	63.3	60.9	44
48				65.1	62.7	60.8	58.4	56.8	54.5	48
52					56.8	55	52.8	51.3	49	52
56						50.1	47.9	46.4	44.3	56
60							43.6	42.2	40.1	60
64							39.8	38.4	36.4	64
68								35.1	33.1	68
72									30.1	72
76									27.4	76

Boom combination in LJDB

Boom combination in LJDB			
Boom length(m)	Boom insert	Jib insert	
	12m	6m	12m
24	-	-	-
30	-	1	-
36	1	-	-
42	1	1	-
48	1	2	-
54	1	1	1
60	1	2	1
66	1	1	2
72	1	2	2
78	1	1	3
84	1	2	3
90*	1	1	4
96*	1	2	4

Note: The boom is the same as HDB Configuration; jib base, 6m tapered section and Jib top are must. The mid-point suspension cable must be used for the boom length with the symbol "*" in this working condition, otherwise, the boom system may be broken.

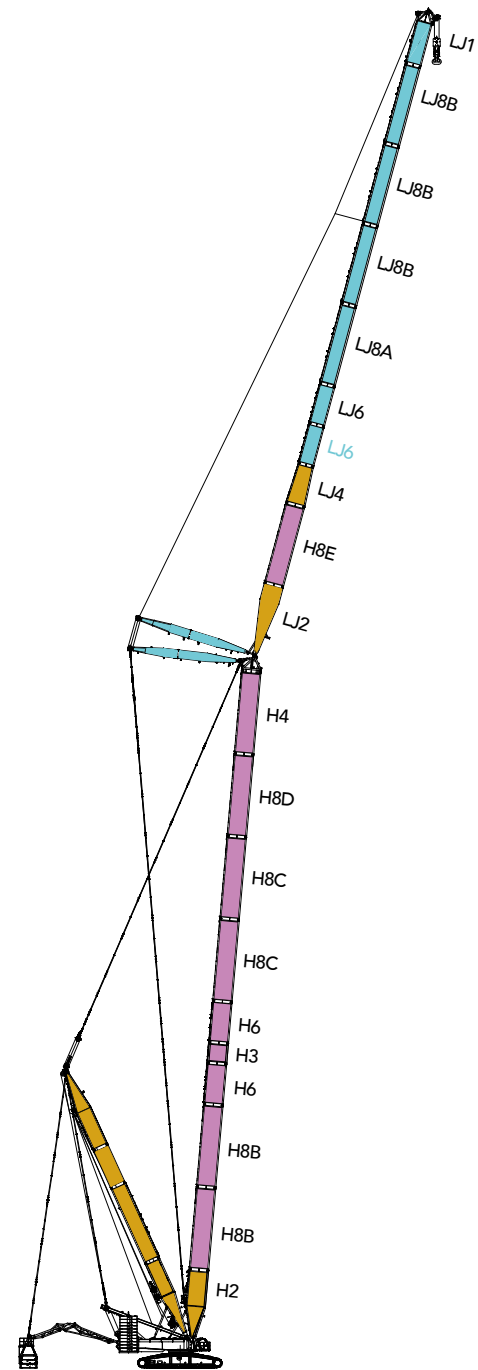

LJDB
(42m~99m)+(24m~96m)

LJDB working radius diagram

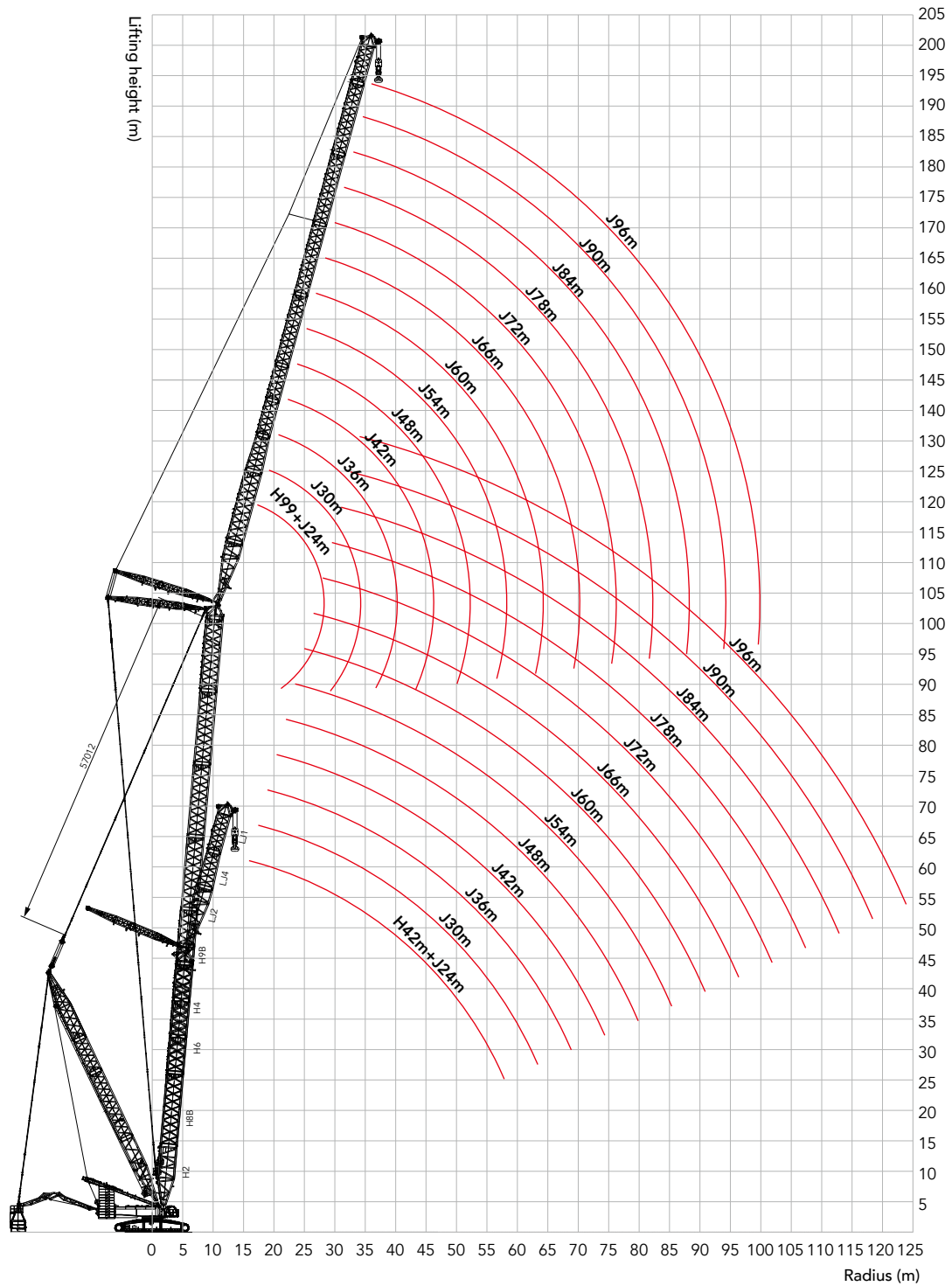

Unit: t

Load chart of LJDB configuration

Note:

1. Meet ISO 4305 standard;
2. The rated load in the table includes the weight of hook, wire rope and other spreader. The weight to be lifted is the sum of the rated load minus the weight of the above items.

LJDB Load Charts - 1/11 (Boom angle 85°, Jib length 24~96m, Superlift Radius 22m, Superlift CWT 390t, Rear CWT 230t, Carbody CWT 80t)														
Boom length 42m														
Radius(m)	24	30	36	42	48	54	60	66	72	78	84	90	96	Radius(m)
14	384													14
16	362	378												16
18	331	355	369											18
20	302	329	352	339	280									20
22	281	307	328	328	279	232								22
24	263	277	290	289	277	231	191							24
26	241	249	259	258	258	229	190	157						26
28	218	225	233	233	233	227	188	156	130					28
30		205	212	212	212	211	187	155	129	107				30
32		189	194	194	194	193	185	153	127	106	88.4			32
34		174	178	178	178	178	177	152	126	104	87.1	81.4	68.9	34
36			164	165	165	164	163	150	124	103	85.9	80.7	68.2	36
38			152	153	153	152	152	148	123	102	84.6	80.0	67.6	38
40			141	142	142	142	141	141	122	100	83.4	79.3	66.9	40
44				124	125	124	124	124	118	97.4	80.9	77.8	65.6	44
48					110	110	110	110	109	94.7	78.4	76.4	64.2	48
52					97.6	98.4	98.1	98.1	97.3	89.6	76.2	74.9	62.9	52
56						87.9	88.0	88.1	87.4	82.3	71.9	73.5	61.5	56
60							79.2	79.5	78.8	75.2	65.1	72.1	60.2	60
64								71.9	71.4	68.6	59.3	69.7	59.0	64
68									65.1	64.8	62.3	53.2	63.3	68
72										58.9	56.4	48.1	57.6	72
76											51.6	43.4	52.5	76
80												47.9	39.0	80
84													35.4	84
88														88
92													36.4	92
96														96

Load chart of LJDB configuration

Note:

1. Meet ISO 4305 standard;
2. The rated load in the table includes the weight of hook, wire rope and other spreader. The weight to be lifted is the sum of the rated load minus the weight of the above items.

LJDB Load Charts - 2/11 (Boom angle 85°, Jib length 24~96m, Superlift Radius 22m, Superlift CWT 390t, Rear CWT 230t, Carbody CWT 80t)

Boom length 48m														
Radius(m)	24	30	36	42	48	54	60	66	72	78	84	90	96	Radius(m)
16	367	368												16
18	336	360	359											18
20	308	333	352	307										20
22	284	311	332	305	256									22
24	266	286	301	303	254	214	178							24
26	248	256	269	270	252	213	178	148						26
28	224	231	243	244	245	211	176	147	123					28
30		210	221	222	223	209	175	146	122	102				30
32		193	203	204	204	207	174	145	121	101	84.8			32
34		178	187	188	188	192	172	144	120	99.9	83.7	77.6		34
36			173	174	174	178	171	142	119	98.8	82.7	77.1	65.3	36
38			162	162	162	166	165	141	118	97.6	81.6	76.5	64.7	38
40			151	152	152	155	154	140	117	96.4	80.5	75.9	64.2	40
44				134	134	136	135	135	114	94.0	78.3	74.7	63.0	44
48					119	120	120	119	111	91.6	76.3	73.6	61.8	48
52					107	107	107	107	103	89.3	74.1	72.3	60.6	52
56						96.4	96.3	96.4	95.0	82.7	71.6	71.1	59.4	56
60							86.9	87.1	86.4	75.9	65.8	69.8	58.3	60
64							78.4	79.0	78.4	69.0	59.4	68.6	57.1	64
68								71.8	71.4	62.8	53.8	67.4	56.0	68
72									65.0	57.5	48.5	63.6	54.9	72
76										52.0	43.8	58.2	54.0	76
80										48.3	39.5	53.3	52.3	80
84											36.0	48.9	48.0	84
88												44.9	44.0	88
92												41.1	40.3	92
96													36.9	96

Unit: t

Load chart of LJDB configuration

Note:

1. Meet ISO 4305 standard;
2. The rated load in the table includes the weight of hook, wire rope and other spreader. The weight to be lifted is the sum of the rated load minus the weight of the above items.

LJDB Load Charts - 3/11 (Boom angle 85°, Jib length 24~96m, Superlift Radius 22m, Superlift CWT 390t, Rear CWT 230t, Carbody CWT 80t)														
Boom length 54m														
Radius(m)	24	30	36	42	48	54	60	66	72	78	84	90	96	Radius(m)
16	372	362												16
18	340	362	330											18
20	313	336	327	278										20
22	289	315	323	276	234									22
24	270	295	310	273	232	197								24
26	253	263	276	270	231	196	165							26
28	229	237	249	250	228	195	164	138	117					28
30	208	215	226	227	226	193	163	138	116	97.1				30
32		197	207	208	209	192	162	137	115	96.3	81.0			32
34		182	191	192	192	189	161	136	114	95.4	80.2	74.0		34
36			177	177	178	182	159	134	113	94.4	79.3	73.6	62.2	36
38			164	165	165	169	158	133	112	93.4	78.3	73.1	61.7	38
40			154	154	154	158	156	132	111	92.4	77.6	72.6	61.3	40
44				136	136	139	138	129	109	90.3	75.7	71.6	60.3	44
48					121	123	122	122	106	88.2	73.7	70.5	59.3	48
52					109	109	109	109	103	86.1	71.8	69.4	58.2	52
56						98.2	98.1	98.1	94.8	83.5	69.8	68.2	57.1	56
60							88.4	88.7	87.7	76.5	66.1	67.1	56.1	60
64							79.8	80.4	79.8	69.8	60.0	65.9	55.2	64
68								73.0	72.6	63.2	54.2	64.8	54.2	68
72									66.2	57.5	49.3	63.7	53.2	72
76									60.2	52.9	44.1	59.2	52.2	76
80										48.5	39.9	54.2	51.3	80
84											36.4	49.8	48.8	84
88											28.2	45.6	44.8	88
92												41.8	41.0	92
96													37.6	96

Load chart of LJDB configuration

Note:

1. Meet ISO 4305 standard;
2. The rated load in the table includes the weight of hook, wire rope and other spreader. The weight to be lifted is the sum of the rated load minus the weight of the above items.

LJDB Load Charts LJDB - 4/11 (Boom angle 85°, Jib length 24~96m, Superlift Radius 22m, Superlift CWT 390t, Rear CWT 230t, Carbody CWT 80t)														
Boom length 60m														
Radius(m)	24	30	36	42	48	54	60	66	72	78	84	90	96	Radius(m)
16	367													16
18	346	338	292											18
20	317	333	292	251										20
22	293	317	288	249	213									22
24	273	297	283	246	212	181								24
26	257	271	277	243	210	180	153							26
28	235	243	256	239	208	179	152	130						28
30	214	221	232	233	205	178	151	129	109					30
32		202	212	213	202	176	150	128	109	91.3				32
34		185	195	196	196	174	149	127	108	90.5	76.6	70.0		34
36		172	180	181	181	171	148	126	107	89.8	75.8	69.7	59.1	36
38			168	168	169	169	146	125	106	88.9	75.0	69.3	58.7	38
40			156	157	157	160	145	124	105	88.0	74.2	68.9	58.3	40
44				138	138	141	140	121	103	86.2	72.5	68.0	57.5	44
48				123	123	125	124	119	101	84.3	70.8	67.1	56.6	48
52					110	111	111	111	98.4	82.4	69.1	66.1	55.7	52
56						99.9	99.8	99.8	94.6	80.6	67.3	65.0	54.8	56
60							89.9	90.1	87.2	76.6	65.6	64.0	53.8	60
64							81.1	81.7	81.0	70.1	60.8	62.9	52.8	64
68								74.2	73.7	64.0	55.1	61.9	51.9	68
72									67.2	58.5	49.7	60.8	51.0	72
76									61.2	53.2	44.7	59.8	50.1	76
80										48.9	40.5	55.1	49.2	80
84											36.6	50.5	48.4	84
88											33.4	46.3	45.5	88
92												42.4	41.7	92
96													38.2	96
100													34.6	100

Unit: t

Load chart of LJDB configuration

Note:

1. Meet ISO 4305 standard;
2. The rated load in the table includes the weight of hook, wire rope and other spreader. The weight to be lifted is the sum of the rated load minus the weight of the above items.

LJDB Load Charts - 5/11 (Boom angle 85°, Jib length 24~96m, Superlift Radius 22m, Superlift CWT 390t, Rear CWT 230t, Carbody CWT 80t)														
Boom length 66m														
Radius(m)	24	30	36	42	48	54	60	66	72	78	84	90	96	Radius(m)
16	346													16
18	338	292												18
20	320	287	253											20
22	297	281	250	217										22
24	277	274	245	215	186	161								24
26	259	267	240	212	185	161	138							26
28	242	250	234	208	183	159	137	118						28
30	219	226	228	204	180	158	136	117	99.8					30
32		206	217	200	177	156	135	116	99.3	84.4				32
34		189	199	195	174	154	134	116	98.6	83.8	71.0			34
36		175	184	185	171	152	133	115	97.9	83.2	70.4	64.2		36
38			171	171	168	150	131	114	97.1	82.5	69.8	63.9	54.2	38
40			159	160	160	148	130	112	96.2	81.8	69.2	63.6	53.9	40
44				140	140	143	126	110	94.4	80.2	67.8	62.8	53.3	44
48				125	125	127	122	107	92.4	78.6	66.3	62.0	52.5	48
52					112	113	113	105	90.5	76.9	64.8	61.3	51.7	52
56						101	101	101	88.4	75.1	63.2	60.3	50.9	56
60							90.9	91.3	91.5	86.3	73.4	61.7	59.4	60
64								82.4	82.9	81.0	70.5	60.3	58.4	64
68									75.3	74.8	64.3	55.3	57.4	68
72										67.6	59.0	50.2	56.4	72
76											60.2	54.0	45.3	76
80												49.2	40.7	80
84													36.9	84
88														88
92													33.9	92
96														96
100														100

Load chart of LJDB configuration

Note:

1. Meet ISO 4305 standard;
2. The rated load in the table includes the weight of hook, wire rope and other spreader. The weight to be lifted is the sum of the rated load minus the weight of the above items.

LJDB Load Charts - 6/11 (Boom angle 85°, Jib length 24~96m, Superlift Radius 22m, Superlift CWT 390t, Rear CWT 230t, Carbody CWT 80t)														
Boom length 72m														
Radius(m)	24	30	36	42	48	54	60	66	72	78	84	90	96	Radius(m)
18	299	260												18
20	291	256	226											20
22	282	250	223	196										22
24	273	244	219	193	169									24
26	261	237	214	190	167	146								26
28	248	230	208	187	165	145	126	109						28
30	225	223	203	183	163	144	125	108	93.0					30
32		211	198	179	160	142	124	108	92.5	79.0				32
34		194	192	175	157	140	123	107	91.9	78.5	66.7			34
36		179	187	171	154	138	121	106	91.2	77.9	66.2	60.1		36
38			174	167	151	136	120	105	90.5	77.3	65.7	59.9	50.7	38
40			162	163	148	133	118	104	89.7	76.7	65.1	59.6	50.5	40
44				143	142	129	115	101	87.9	75.2	64.0	59.0	50.0	44
48				127	127	124	111	98.8	86.0	73.7	62.7	58.2	49.4	48
52					113	115	107	96.1	83.9	72.1	61.3	57.3	48.6	52
56						103	103	93.3	81.8	70.4	59.9	56.4	47.9	56
60						90.0	91.0	90.0	79.6	68.7	58.4	55.4	47.0	60
64							79.4	79.6	77.5	67.0	57.0	54.4	46.2	64
68								70.6	70.0	64.5	55.6	53.4	45.3	68
72								62.0	61.8	59.4	50.4	52.4	44.5	72
76									54.6	53.9	45.7	51.4	43.6	76
80										48.6	41.2	48.0	42.8	80
84											37.6	42.8	41.8	84
88											34.2	38.2	37.4	88
92												34.4	33.6	92
96													30.0	96
100													26.6	100

Unit: t

Load chart of LJDB configuration

Note:

1. Meet ISO 4305 standard;
2. The rated load in the table includes the weight of hook, wire rope and other spreader. The weight to be lifted is the sum of the rated load minus the weight of the above items.

LJDB Load Charts - 7/11 (Boom angle 85°, Jib length 24~96m, Superlift Radius 22m, Superlift CWT 390t, Rear CWT 230t, Carbody CWT 80t)														
Boom length 78m														
Radius(m)	24	30	36	42	48	54	60	66	72	78	84	90	96	Radius(m)
18	257	221												18
20	250	221	196											20
22	242	216	193	170										22
24	234	211	189	168	148									24
26	226	205	185	165	146	129								26
28	219	199	181	162	144	128	112							28
30	212	193	176	159	142	126	111	96.8						30
32	206	187	171	155	140	125	110	96.1	83.1	71.6				32
34		182	166	152	137	123	109	95.3	82.5	71.2	60.8			34
36		177	162	148	134	121	107	94.4	81.9	70.7	60.4	54.4		36
38		169	157	144	131	119	106	93.4	81.2	70.2	59.9	54.2	46.0	38
40			153	141	128	116	104	92.3	80.4	69.6	59.4	53.9	45.7	40
44				134	123	112	101	89.9	78.6	68.2	58.3	53.3	45.2	44
48				128	117	108	97.3	87.3	76.7	66.8	57.1	52.6	44.6	48
52					110	103	93.9	84.7	74.7	65.2	55.9	51.7	43.9	52
56						95.6	90.4	82.0	72.8	63.6	54.5	50.8	43.2	56
60						83.6	83.0	79.3	70.7	62.0	53.2	49.8	42.5	60
64							73.0	73.0	68.6	60.3	51.9	48.8	41.6	64
68								64.6	64.0	58.7	50.6	47.7	40.8	68
72								56.8	56.6	56.2	49.2	46.7	39.9	72
76									50.2	49.8	46.2	45.6	39.0	76
80										44.4	41.9	42.8	38.1	80
84										39.4	37.9	38.6	37.2	84
88											34.1	34.4	33.0	88
92												30.4	29.6	92
96													26.4	96
100													23.2	100

Load chart of LJDB configuration

Note:

1. Meet ISO 4305 standard;
2. The rated load in the table includes the weight of hook, wire rope and other spreader. The weight to be lifted is the sum of the rated load minus the weight of the above items.

LJDB Load Charts - 8/11 (Boom angle 85°, Jib length 24~96m, Superlift Radius 22m, Superlift CWT 390t, Rear CWT 230t, Carbody CWT 80t)

Boom length 84m														
Radius(m)	24	30	36	42	48	54	60	66	72	78	84	90	96	Radius(m)
18	228													18
20	222	197												20
22	216	193	173	153										22
24	209	188	169	151	133									24
26	202	183	165	148	132	117								26
28	195	177	161	145	130	116	101							28
30	189	172	157	142	128	114	101	88.3						30
32	183	167	152	139	125	113	99.4	87.6	76.2					32
34		162	148	135	123	111	98.2	86.8	75.7	65.5				34
36		157	144	132	120	109	96.8	85.9	75.1	65.1	55.8	49.9		36
38		154	140	129	118	107	95.4	84.8	74.3	64.5	55.4	49.7	42.2	38
40			136	125	115	105	93.8	83.7	73.5	64.0	55.0	49.5	42.0	40
44			130	119	110	100	90.6	81.3	71.8	62.6	53.9	48.8	41.5	44
48				114	105	96.1	87.2	79.0	69.9	61.2	52.8	48.1	40.9	48
52					99.9	92.0	83.8	76.3	67.8	59.6	51.5	47.2	40.2	52
56						88.2	80.6	73.7	65.7	58.0	50.2	46.2	39.5	56
60						78.0	77.2	71.1	63.6	56.5	48.9	45.3	38.6	60
64							67.8	67.4	61.5	54.8	47.5	44.2	37.8	64
68								60.0	58.6	53.2	46.1	43.1	37.0	68
72								52.6	52.4	51.4	44.8	42.0	36.1	72
76									45.8	46.0	43.6	40.8	35.1	76
80										40.4	39.4	39.0	34.2	80
84											36.0	35.2	34.6	84
88												31.2	30.8	88
92													27.2	92
96													24.2	96
100														100

Unit: t

Load chart of LJDB configuration

Note:

1. Meet ISO 4305 standard;
2. The rated load in the table includes the weight of hook, wire rope and other spreader. The weight to be lifted is the sum of the rated load minus the weight of the above items.

LJDB Load Charts - 9/11 (Boom angle 85°, Jib length 24~96m, Superlift Radius 22m, Superlift CWT 390t, Rear CWT 230t, Carbody CWT 80t)														
Boom length 90m														
Radius(m)	24	30	36	42	48	54	60	66	72	78	84	90	96	Radius(m)
18	193													18
20	189	168												20
22	183	164	147											22
24	178	160	144	129										24
26	172	156	141	126	113	99.8								26
28	166	151	137	124	111	98.8	87.2							28
30	161	147	134	121	109	97.5	86.3	76.2						30
32	157	142	130	118	107	96.0	85.3	75.6	65.9					32
34		138	126	115	105	94.3	84.2	74.8	65.4	56.9				34
36		134	123	112	102	92.6	82.9	73.9	64.8	56.5	48.6			36
38		131	119	110	99.8	90.8	81.5	72.9	64.1	56.0	48.2	42.8		38
40			116	107	97.5	89.1	80.1	71.9	63.3	55.5	47.8	42.6	36.1	40
44			110	101	92.9	85.3	77.1	69.6	61.6	54.2	46.8	41.9	35.6	44
48				96.7	88.5	81.6	74.1	67.2	59.8	52.8	45.7	41.1	35.0	48
52					84.6	78.1	71.1	64.7	57.8	51.3	44.5	40.3	34.3	52
56					81.6	74.8	68.2	62.3	55.9	49.7	43.2	39.3	33.6	56
60						71.8	65.4	60.1	53.9	48.1	41.9	38.3	32.7	60
64							62.6	57.8	51.9	46.6	40.6	37.2	31.8	64
68							55.4	54.8	50.0	45.0	39.3	36.1	30.9	68
72								48.2	47.6	43.5	38.1	34.9	30.0	72
76									42.0	41.4	36.8	33.9	29.1	76
80										36.4	35.4	32.8	28.1	80
84										32.4	31.2	30.4	27.2	84
88											27.8	27.2	25.8	88
92												24.0	22.8	92
96												21.2	20.0	96
100													17.4	100

Load chart of LJDB configuration

Note:

1. Meet ISO 4305 standard;
2. The rated load in the table includes the weight of hook, wire rope and other spreader. The weight to be lifted is the sum of the rated load minus the weight of the above items.

LJDB Load Charts - 10/11 (Boom angle 85°, Jib length 24~96m, Superlift Radius 22m, Superlift CWT 390t, Rear CWT 230t, Carbody CWT 80t)														
Boom length 96m														
Radius(m)	24	30	36	42	48	54	60	66	72	78	84	90	96	Radius(m)
20	168	150												20
22	164	147	131											22
24	159	143	129	115										24
26	154	139	126	113	101									26
28	149	135	123	111	99.3	88.8								28
30	144	131	119	108	97.5	87.5	77.4	68.7						30
32	140	127	116	106	95.5	86.1	76.4	68.1	59.3					32
34		123	113	103	93.5	84.6	75.3	67.3	58.8	51.4				34
36		120	109	100	91.3	82.9	74.1	66.4	58.2	51.0	43.7			36
38		117	106	97.5	89.1	81.2	72.8	65.5	57.5	50.5	43.4	38.4		38
40			103	94.9	87.0	79.4	71.6	64.4	56.7	50.0	43.0	38.1	32.1	40
44			98.4	90.0	82.7	75.9	68.8	62.2	55.0	48.7	42.1	37.4	31.6	44
48				85.9	78.7	72.4	65.9	59.9	53.3	47.3	41.0	36.6	31.0	48
52					75.1	69.1	63.0	57.5	51.4	45.8	39.8	35.7	30.3	52
56					72.0	66.0	60.3	55.2	49.5	44.2	38.5	34.7	29.5	56
60						63.3	57.7	52.9	47.6	42.6	37.2	33.6	28.7	60
64							55.3	50.8	45.7	41.1	35.9	32.5	27.7	64
68							51.4	48.9	43.9	39.6	34.6	31.4	26.8	68
72								44.8	42.2	38.1	33.3	30.3	25.9	72
76									38.8	36.6	32.1	29.1	24.9	76
80									34.6	33.6	30.9	28.0	23.9	80
84										29.8	28.6	26.9	23.0	84
88											25.2	24.4	22.1	88
92												21.2	20.2	92
96												18.8	17.6	96
100													15.2	100

Unit: t

Load chart of LJDB configuration

Note:

1. Meet ISO 4305 standard;
2. The rated load in the table includes the weight of hook, wire rope and other spreader. The weight to be lifted is the sum of the rated load minus the weight of the above items.

LJDB Configuration - 11/11 (Boom angle 85°, Jib length 24~96m, Superlift Radius 22m, Superlift CWT 390t, Rear CWT 230t, Carbody CWT 80t)														
Boom length 99m														
Radius(m)	24	30	36	42	48	54	60	66	72	78	84	90	96	Radius(m)
20	159	139												20
22	154	139	124											22
24	150	135	121	109										24
26	145	132	119	107	95.3									26
28	140	128	116	105	93.8	83.9								28
30	136	124	112	102	92.0	82.6	73.3							30
32	132	120	109	99.7	90.1	81.3	72.3	64.3	56.2					32
34	129	116	106	97.2	88.1	79.7	71.3	63.6	55.7	48.6				34
36		113	103	94.6	86.0	78.1	70.0	62.7	55.1	48.2	41.4			36
38		110	100	92.0	84.0	76.5	68.8	61.7	54.4	47.7	41.0	36.2		38
40			97.3	89.6	81.9	74.8	67.4	60.7	53.6	47.1	40.6	35.9	30.2	40
44			92.5	84.9	77.8	71.3	64.7	58.5	51.9	45.9	39.6	35.2	29.7	44
48				80.7	73.9	68.1	61.8	56.3	50.1	44.5	38.5	34.3	29.0	48
52					70.4	64.9	59.1	53.9	48.2	43.1	37.3	33.4	28.3	52
56					67.4	62.0	56.4	51.8	46.3	41.5	36.1	32.4	27.5	56
60						59.3	53.9	49.6	44.4	39.9	34.8	31.3	26.6	60
64							51.6	47.5	42.6	38.4	33.5	30.2	25.7	64
68							49.6	45.5	40.9	36.8	32.2	29.0	24.7	68
72								43.2	39.2	35.3	30.9	27.9	23.8	72
76									37.0	34.0	29.7	26.8	22.8	76
80									33.0	32.2	28.5	25.7	21.8	80
84										28.2	27.0	24.6	20.9	84
88											23.8	23.0	19.9	88
92												20.4	18.8	92
96												17.6	16.4	96
100													14.2	100

Boom combination in ZHEDB

Boom combination in ZHEDB									
Boom length (m)	Power boom length				Boom insert length				Eagle tip 7m
	12mA	12mB	12mC	12mD	3m	6m	12mC	12mD	
93	1	1	1	-	1	-	-	-	
99	1	1	2	-	-	-	-	-	
105	1	1	2	-	-	1	-	-	
111	1	1	2	1	-	-	-	-	
117	1	1	2	1	-	1	-	-	
123	1	1	2	2	-	-	-	-	
129	1	1	2	2	-	1	-	-	
135	1	1	2	3	-	-	-	-	
141	1	1	2	3	-	1	-	-	
147	1	1	2	3	-	-	-	1	
153	1	1	2	3	-	1	-	1	
159	1	1	2	3	-	-	1	1	
165	1	1	2	3	-	1	1	1	
171	1	1	2	3	-	2	1	1	

Note: 10.5 m boom base, 12 m boom transition section, 12m power boom lower transition, 12m power boom upper transition.
In this working condition with boom length (135m+ 7m-171m +7m), the waist rope must be used, otherwise the boom frame may be broken.

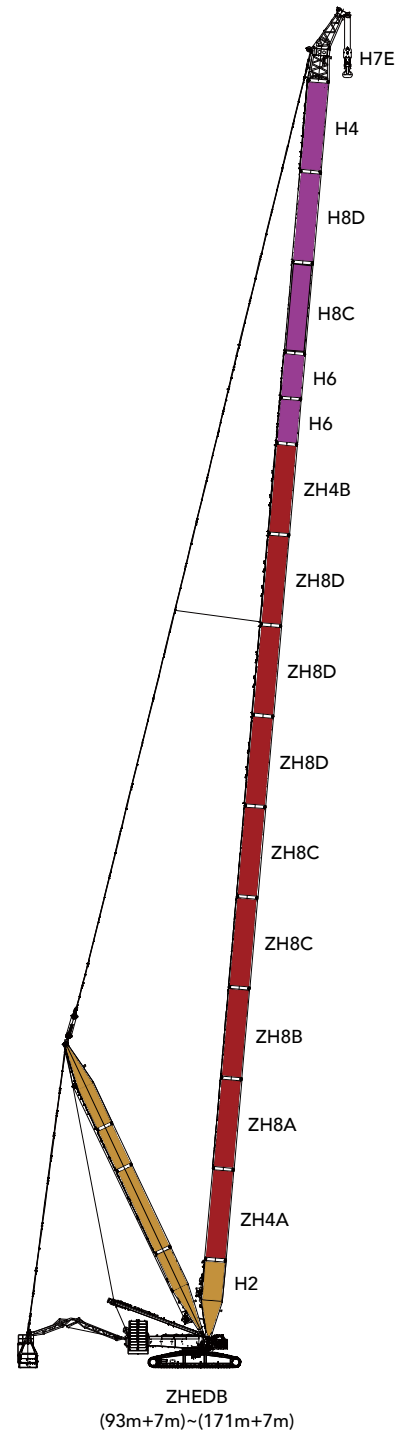

ZHEDB working radius diagram

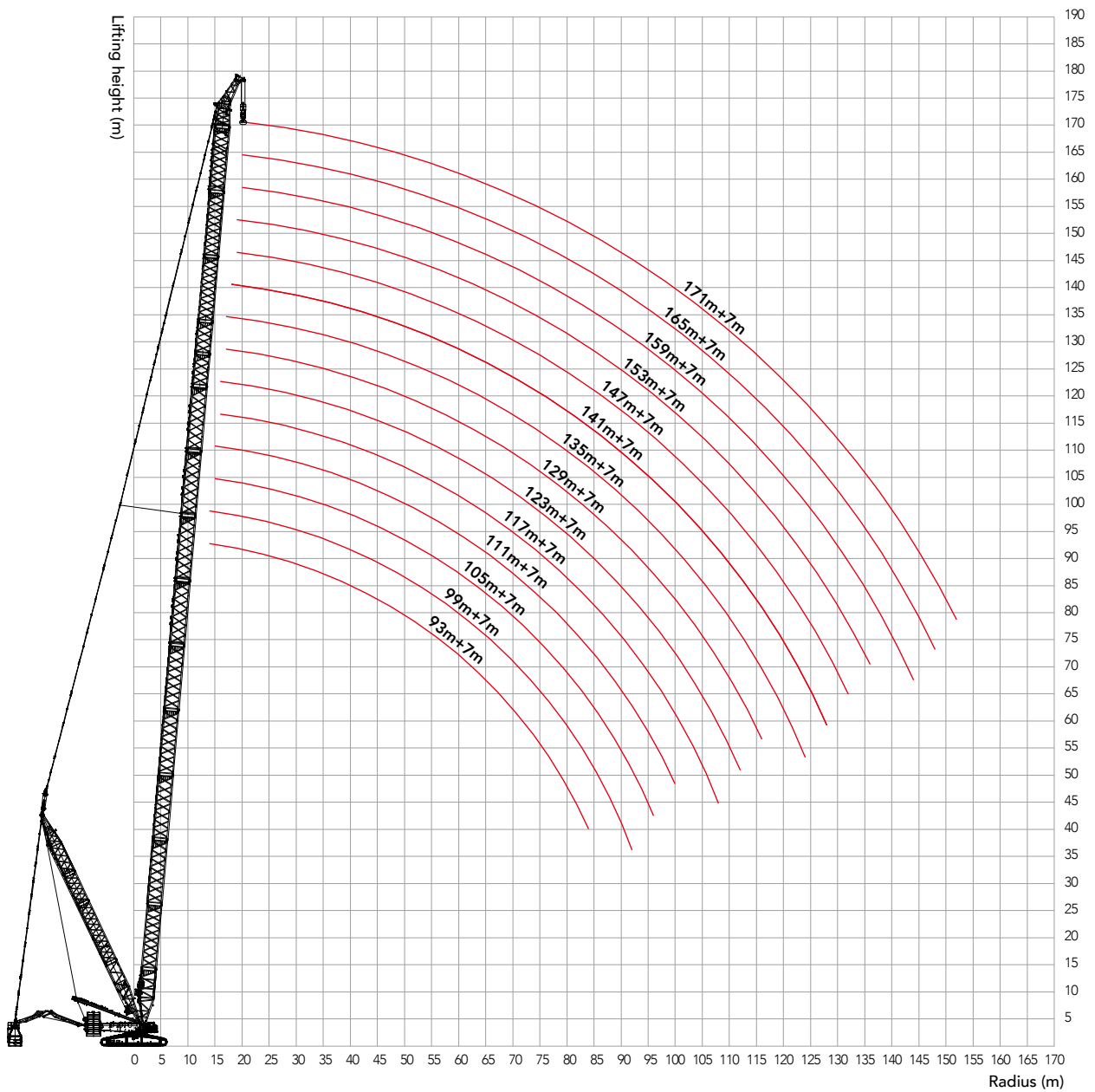

Load chart of ZHEDB configuration

Note:

1. Meet ISO 4305 standard;
2. The rated load in the table includes the weight of hook, wire rope and other spreader. The weight to be lifted is the sum of the rated load minus the weight of the above items.

ZHEDB Load Chart (Boom length 93~171m, Superlift radius 22m, Superlift counterweight 390t, Rear counterweight 230t, Carbody counterweight 80t)															
Radius (m)	93	99	105	111	117	123	129	135	141	147	153	159	165	171	Radius (m)
15	240	240													15
16	240	240	240	240											16
17	240	240	240	240	240	230									17
18	240	240	240	240	240	230	213	195							18
19	239	240	240	240	240	236	213	195	177						19
20	237	239	240	240	240	236	213	196	177	161	146				20
22	235	235	238	238	238	238	214	196	179	161	146	133	120	108	22
24	231	234	234	236	236	236	214	197	179	162	147	133	120	107	24
26	229	229	232	233	233	235	215	197	178	162	147	133	120	107	26
28	225	227	230	231	231	231	216	198	179	162	147	133	120	107	28
30	222	225	226	229	228	221	212	197	179	163	147	133	119	106	30
32	220	222	223	225	227	219	199	192	180	162	147	133	119	106	32
34	215	220	221	223	215	207	199	181	174	163	148	133	118	105	34
36	209	215	219	212	203	196	188	181	164	160	147	132	118	105	36
38	203	207	209	201	193	186	178	172	165	151	145	132	117	104	38
40	198	202	199	191	184	177	169	163	157	152	137	131	117	104	40
44	188	193	197	180	167	161	154	148	142	138	132	128	115	103	44
48	179	184	180	174	158	152	141	136	130	126	120	116	111	102	48
52	171	171	166	161	155	140	134	129	119	115	110	106	101	97.1	52
56	163	169	153	148	143	138	132	119	114	111	101	98.1	93.4	88.8	56
60	157	158	154	137	133	128	123	118	106	102	98.0	94.5	85.9	81.4	60
64	151	146	143	139	127	119	114	110	105	95.4	90.8	87.4	83.0	78.7	64
68	145	144	132	130	126	114	106	102	98.3	95.4	84.3	81.1	76.8	72.6	68
72	135	133	131	120	117	114	102	96.0	91.7	89.0	84.6	81.5	71.2	67.1	72
76	125	124	122	120	109	106	102	92.5	88.4	83.1	79.0	76.0	71.9	62.1	76
80	117	115	113	112	109	99.6	96.2	93.1	82.6	80.4	73.7	70.9	67.0	63.0	80
84	109	107	105	104	102	100	89.9	87.1	83.5	75.2	71.4	66.2	62.4	58.6	84
88	101	100	98.6	97.4	95.2	93.6	84.0	81.5	78.1	76.3	66.7	64.3	60.6	54.5	88
92		93.7	92.1	90.9	89.1	87.3	84.9	76.2	73.1	71.5	68.1	60.0	56.5	52.9	92
96			86.0	84.9	83.1	81.8	79.3	77.4	68.3	66.9	63.7	61.5	52.6	49.2	96
100			80.4	79.3	77.5	76.3	73.8	72.3	69.7	62.6	59.5	57.5	54.2	45.6	100
104				74.1	72.4	71.2	69.3	67.3	65.0	64.2	55.5	53.7	50.5	47.3	104
108					67.6	66.4	64.5	63.2	60.5	59.9	57.3	50.0	47.0	43.9	108
112						61.9	60.1	58.8	56.8	55.8	53.4	51.9	43.7	40.7	112
116						57.6	56.0	54.7	52.7	52.5	49.6	48.3	40.5	37.6	116
120							51.9	50.8	48.9	48.7	45.9	44.9	42.4	34.7	120
124								47.0	45.2	45.1	43.1	41.5	39.2	36.6	124
128									41.7	41.6	39.7	38.9	36.0	33.7	128
132										38.3	36.5	35.7	33.8	30.8	132
136											35.2	33.4	32.7	27.9	136
140												30.4	29.7	25.9	140
144													26.9	23.1	144
148														22.4	148
152														19.9	152
156															156



Zhejiang Sany Equipment Co.,LTD

SANY Crawler Crane Industrial Park, No. 2188 Daishan Road, Wuxing District, Huzhou City,
Zhejiang Province, P. R. China Zip 313028
Consulting sanycrane@sanygroup.com (Crane BU) / crd@sany.com.cn (IHQ)
After-sales Service 0086-400 6098 318

Reminder:

Any change in the technical parameters and configuration due to product modification or upgrade may occur without prior notice.
The machine in the picture may include additional equipment. This brochure is for reference only, and goods in kind shall prevail.
Copyright at SANY. No part of this brochure may be copied or used for any purpose without written approval from SANY.

© Edited in November 2023

