



# SCC600A-6

## Crawler Crane

### 60 Tons Lifting Capacity

Quality Changes the World



**Max lifting capacity: 60t**  
**Max. boom length: 52m**  
**Max. fixed jib combination: 43m+15.25m**

The parameters, pictures and standard/optional equipment are only for reference in this brochure, the actual machine is based on the effective price list and contract.



## Crawler Crane Series SCC600A-6

P03

Main  
Characteristics

- Product Specification
- Safety Device

P09

Technical  
Parameters

- Major Performance & Specifications
- Outline Dimension
- Transport Dimension
- Transport Plan

P17

Cofigurations

- H Configuration
- FJ Configuration



**SCC600A-6**  
**SANY CRAWLER CRANE**  
**60 TONS LIFTING CAPACITY**

QUALITY CHANGES THE WORLD

## Main Characteristics

- Page 04 Product Specification
- Page 07 Safety Device



## Product Specification



### Engine

- Model: DF Cummins QSB5.9-C210 diesel engine;
- Type: 4-stroke, water-cooled, 6 cylinders vertical in-line, direct injection, turbo-charger, intercooler, complied with European Off highway Tier III Emission Standard and chinese Off highway Tier III Emission Standard;
- Displacement: 5.9L;
- Rated power: 154kW/2200rpm;
- Max. torque: 820N·m/1500rpm;
- Starter: 24V-6.0kW.
- Model: WEICHAI WP6G190 Diesel engine;
- Type: 4-stroke, water-cooled, 6 cylinders vertical in-line, direct injection, turbo-charger, intercooler, complied with Chinese Non-road Tier III Emission Standard;
- Displacement: 6.75L;
- Rated power: 140kW/2000rpm;
- Max. Torque: 860N·m/1300~1500rpm;
- Starter: 24V-4.25kW;
- Batteries: Two 12V capacity batteries, connected in series;
- Fuel tank capacity: 400L.

### Electrical Control System

- Self-developed SYIC-II integrated control system is adopted with higher integration, precise operation and reliable quality;
- Control system consists of power system, engine system, main control system, LMI system, auxiliary system and safety monitoring system. CAN BUS is used for data communication between controller, monitor and the engine;
- Monitor: the working parameters and status are shown on the monitor, such as the engine speed, fuel volume, engine oil pressure, servo pressure, engine working hours, lifting conditions and boom angle;
- The Sky Eye system and the function to get on/off the trailer by remote control are offered optionally.

### Hydraulic System

- Main pumps: open variable displacement piston pumps of large displacement are adopted to provide oil supply for main actuators of main machine;
- Gear pump: dual gear pump for swing, radiator and control circuit;
- Control: main pump adopts electrically-controlled positive flow control; winch motor adopts limitless adjustable piston motor of variable displacement. The operating components are two cross hydraulic handle, one dual travel pedal control valve to control various actuators proportionally;
- Way of cooling: heat exchanger, fan core and multi-stage cooling;
- Filter: large flow, high precision filter, with bypass valve and transmitter, which can remind the user to replace the filter element in time;
- Max. pressure of system: 32Mpa;
- Main/aux. load hoist and travel system: 32Mpa;
- Swing system: 24MPa;
- Control system: 5MPa;
- Hydraulic Tank Capacity: 305L.

### Main and Aux. Load Hoist Mechanism

- Main and aux. hoist winches are driven separately by motor via gearbox. Operating winch handle can control the winch to rotate to two directions, which are lifting and lowering of hook. Excellent inching function is equipped on the machine;
- Drums with fold-line grooves can ensure the wire rope reeved in order in multilayers;
- Free fall for main/aux. load hoist are offered as optional.

Main Load Hoist Mechanism	Drum diameter	520mm
	Rope speed of main winch	0~130m/min
	Wire rope diameter	φ22 mm
	Wire rope length of main load hoist	180m
Aux. Load Hoist Mechanism	Rated single line pull	7t
	Drum diameter	520mm
	Rope speed of aux. winch	0~130m/min
	Wire rope diameter	φ22 mm
	Wire rope length of aux. load hoist	130m
	Rated single line pull	7t



## Product Specification

### Boom Hoist

- Boom hoist winch is driven separately by motor via gearbox. Operating winch handle can control the winch to rotate to two directions, which are lifting and lowering of boom;
- Drums with fold-line grooves can ensure the wire rope reeved in order in multilayers.

Boom hoist	Drum diameter	355 mm
	Boom hoist rope speed	0 ~ 80 m/min
	Wire rope diameter	φ16 mm
	Wire rope length of boom hoist	142 m

### Swing Mechanism

- Swing brake adopts wet, spring loaded, normally-closed brake, and braking through spring force;
- Swing system, equipped with integrated swing buffer valve, has free slipping function. It is featured in steady starting and control, and excellent inching function. Unique swing buffer design and steadier brake;
- Swing drive: internal engaged swing drive with 360° swing range, and the max. swing speed is 1.9r/min;
- Swing lock: pin lock can ensure the upperworks locked securely after work or during transport;
- Swing ring: single row ball bearing.

### Cab and Control

- The upgraded cab is designed with interior and control consoles more softened and consistent. The hatchback glass at front and sliding windows at two sides ventilate the cab and facilitate the communication with outsides. There are low/high-beam lights, back-view mirror, panoramic roof glass, A/C, radio and other functions. The layout of seat, handles, control buttons are designed with ergonomic principles to make operation more comfortable;
- Monitor: Integrated touch screen, independent monitoring display and man-machine interaction interface are more perfect;
- Armrest box: on the left and right armrest box are control handles, electrical switches, emergent stop and ignition switch. The armrest box can be adjusted along with the seat;
- Seat: multi-way and multi-level floating adjustable seat with unload switch;
- A/C: cool and heat air; optimized air channels and vents;
- The display with back video can monitor in real time the conditions behind the counterweight and surrounding the machine.

### Counterweight

- Counterweight trays and blocks are stacked for easier assembly and transport;
- Total rear counterweight: 16.1 t (approximately);
- Rear counterweight including: counterweight tray 4.4t\*1, counterweight block I 5.7t\*1, left counterweight block 3t\*1, right counterweight block 3t\*1.

### Upperworks

- High-strength steel weld framework, with no torsion or deformation. The parts are laid out in the way that is easier for maintenance and service.

## Product Specification



### Lowerworks

- Independent travel driving units are adopted for each side of the crawler, to realize straight walking and turning driven by travel motor through gearbox and drive wheel.

### Crawler Extension and Retraction

- The crawlers can extend and retract via cylinders. During Work Mode, the crawlers must be extended, and be retracted during transport with crawlers on.

### Crawler Tensioning

- The jack is used to push the guide wheel and insert the shim to adjust crawler tension.

### Track Pad

- High-strength alloy cast steel track pad can prolong the service life;
- They are 760mm wide, and the total amount is 60pcs x 2.

### Operating Equipment

- All chords of boom of operating equipment are high-strength steel tubes, and the boom/jib top sheaves are made of high-strength anti-wearing Nylon material protecting wire rope. The hooks are installed with milled welded steel sheave. Pendant cables with quick hitch connector that are easy to assemble are offered as options.

### Boom

- Lattice structure. The chord adopts high-strength structural tube and each section is connected through pins;
- Basic boom: 6.5m boom top+6.5m boom base;
- Insert: 3m×1,6m×3,9m×2;
- Boom length: 13m~52m.

### Fixed Jib

- Lattice structure. The chord adopts high-strength structural tube and each section is connected through pins;
- Basic jib: 3.05m jib top +3.05m jib base;
- Insert: 3.05m×3;
- Length of fixed jib: 6.1m~15.25m;
- Longest boom+jib: 43m boom + 15.25m jib.

### Extension Jib

- The extension jib is a welded structure connected to the boom by pins, used for auxiliary hook;
- Extension jib length: 1.0m .

### Hook Block

- 60t hook block, 5 sheaves;
- 45t hook block, 3 sheaves;
- 15t hook, 1 sheave;
- 9t ball hook.

### Hook limitation height

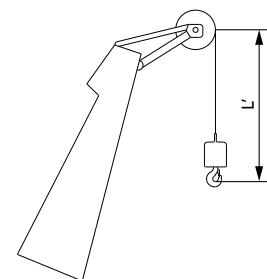
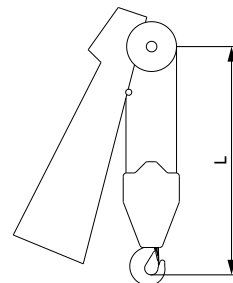

Hook	L
60t	3.2m
45t	3.1m
15t	2.9m

Hook	L'
9t	2.8m



## Safety Device

### Installation/working mode switching switch

- In Assembly Mode, certain safety devices are disabled to facilitate crane assembly;
- In Work Mode, all safety limiting devices activate to protect the operation.

### Emergency Stop

- In emergency situation, this button is pressed down to cut off the power supply of the whole machine and all actions stop.

### Load Moment Indicator (LMI)

- It is an independent computerized safety control system. LMI can automatically detect the load weight, work radius and boom angle, and present on the display the rated load, actual load, work radius and boom angle. In normal operation, the LMI can make a judgment and cut off automatically if the crane moves towards dangerous direction. It can also perform as a black box to record the lifting information;
- Composition: monitor, angle sensor, force sensor and other parts.

### Over-hoist Protection of the Main/Auxiliary Load Hoist

- Over-hoist protection device comprises limit switch and weight on boom top, which prevents the hook lifting up too much. When the hook is lifted up to the limit height, the limit switch activates, buzzer on the left control panel sends alarm, failure indicator light starts to flash and the hook hoisting action is cut off automatically.

### Over-release Protection Device of the Main/Auxiliary Load Hoist

- It is comprised of activator in the drum and proximity switch to prevent over-release of wire rope. When the rope is paid out close to the last three wraps, the proximity switch acts, and the system sends alarm through buzzer and show the alarm on the monitor, automatically cutting off the winch action.

### Function Lock

- If the function lock lever is not in work position, all the other handles won't work, which prevents any mis-operation caused by accidental collision.

### Boom Hoist Drum Lock

- Boom hoist lock is designed to lock the drum when the boom doesn't need to move, in order to prevent mis-operation. The boom hoist pawl can open and close by control of handle, and when the handle return to neutral position, the pawl will lock the drum automatically to ensure the work safety of boom.

### Slewing Lock

- Slewing Lock can lock the upperworks and lowerworks of crane in front, rear, left and right directions.

### Boom Limit Device

- When the boom elevation angle reaches the upper limit, the buzzer sounds and boom action is cut off. This protection is two-stage control ensured by both LMI system and travel switch.

### Back-stop Device

- Its major components are nesting tubes and spring, in order to buffer the boom backlash and prevent further tipping back.

### Boom Angle Indicator

- Pendulum angle indicator is fixed on the side of boom base close to the cab, so as to provide convenience to the operator.

### Hook Latch

- The lifting hook is installed with a baffle plate to prevent wire rope from falling off.

## Safety Device



### Tri-color Load Indicator

- The load indicator light has three colors, i.e., green, yellow and red; and the real time load status is presented on the display. When the actual load is smaller than 90% of rated load, the green light is on; when the actual load is larger than 90% and smaller than 100%, the yellow light is on, the alarm light flashes and sends out intermittent sirens; when the actual load reaches 102% of rated load, the red light is on, the alarm light flashes and sends out continuous sirens. At this moment, the system will automatically cut off the crane's dangerous operation.

### Alarm Light

- When the machine is powered on, the alarm light will work when time comes, so as to warn people around.

### Swing Indicator Light

- The slewing indicator light flashes during traveling or slewing.

### Illuminating Light

- The machine is equipped with short-beam light in front of machine, front angle adjustable far-beam light, lamps in operator's cab, lighting devices for night operation, so as to increase the visibility during work.

### Rearview Mirror

- It is installed on the left of the operator's cab and at the front handrail of the sheet metal for monitoring the rear part of the machine.

### Pharos

- Pharos is mounted on the top of boom/jib to indicate the height.

### Anemometer

- It is mounted on the top of boom/jib, and displayed on the monitor in the cab.

### Electronic Level Gauge

- It displays the tipping angle of crane on the monitor in real time and sends out alarm to the operator automatically when the angle is out of limit.

### Seat Interlock

- If the operator leaves the seat, all control handles will be locked immediately to prevent any mis-operation due to accidental collision.

### Engine Power Limit Load Adjustment and Stalling Protection

- The controller monitors the engine power to prevent engine getting stuck and stalling.

### Engine Status Monitoring

- The engine status will be presented, such as engine coolant temperature, fuel volume, total work hours, engine oil pressure, engine speed, battery charging and voltage.

### Monitoring system

- Standard remote monitoring system: It can provide functions like GPS locating, GPRS data transfer, machine status inquiry and statistics, operating data monitoring and analysis, and remote diagnosis of failures.





**SCC600A-6**  
**SANY CRAWLER CRANE**  
**60 TONS LIFTING CAPACITY**

QUALITY CHANGES THE WORLD

## Technical Parameters

- Page 10 Major Performance & Specifications
- Page 11 Outline Dimension
- Page 12 Transport Dimension
- Page 16 Transport Plan



## Major Performance & Specifications

Major Performance & Specifications of SCC600A-6			
Performance Indicators		Unit	Parameter
Boom Configuration	Max. rated lifting capacity	t	60
	Largest lifting moment	t m	222
	Boom length	m	13~52
Fixed jib	Max. rated lifting capacity	t	7
	Jib length	m	6.1~15.25
	Longest boom + jib	m	43+15.25
Speed	Rope speed of main/auxiliary load hoist winch	m/min	0~130
	Rope speed of boom hoist winch	m/min	0~80
	Swing speed	rpm	0~1.9
	Travel speed	km/h	0~1.3
Wire rope	Main load hoist wire rope: Diameter × length	φmm × m	φ22×180
	Auxiliary load hoist wire rope: Diameter × length	φmm × m	φ22×130
	Rated single line pull of main/aux. load hoist wire rope	t	7
Engine	Model/Displacement	\L	DF Cummins QSB5.9-C210\5.9 WEICHAI WP6G190\6.75
	Rated power/revolution speed	kW/rpm	DF Cummins 154/2200 WEICHAI 140/2000
Transport	Weight of machine with basic boom	t	48
	Rear counterweight	t	16
	Transport weight of basic machine (with crawler frames and boom base)	t	30.5
	Machine transport dimension (with crawler frames and boom base) L × W × H	m	12.1×3×3.35
Other specifications	Average ground pressure (basic boom)	MPa	0.062
	Gradeability	%	40

Unit: mm

### Outline Dimension

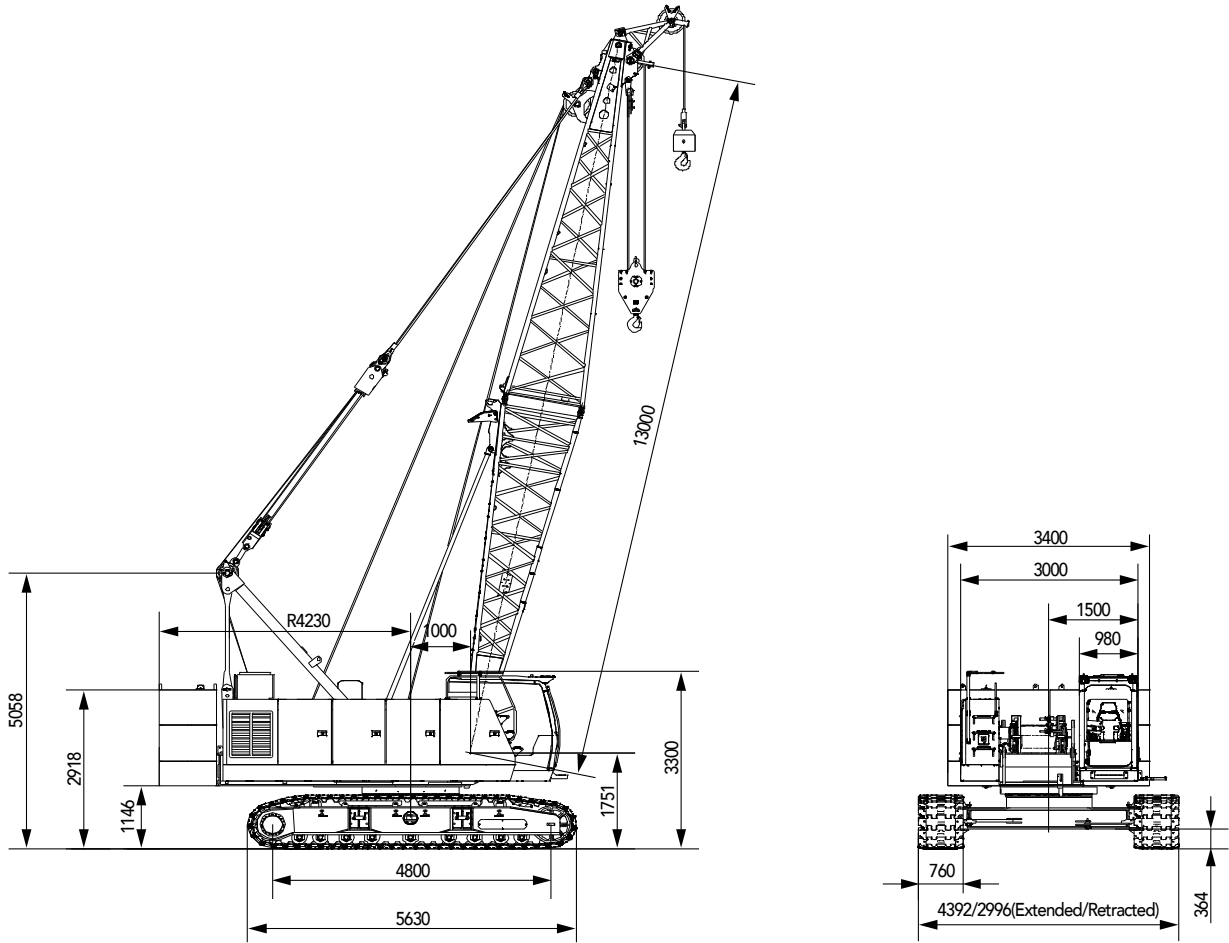

## Transport Dimension

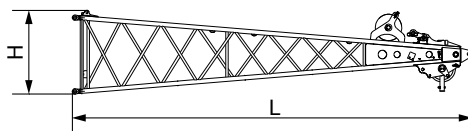
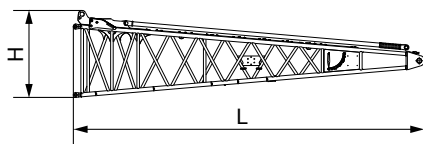
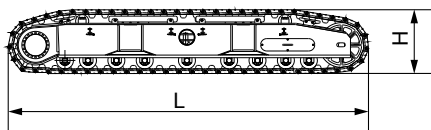
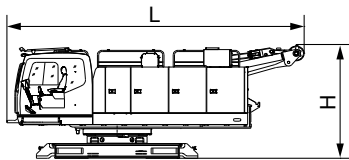
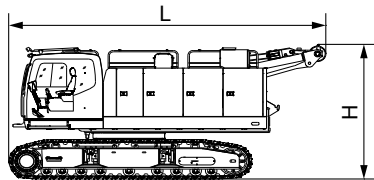
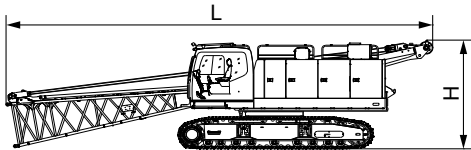

### Basic machine 1 ×1

Length(L)	12.10m
Width(W)	3.00m
Height(H)	3.35m
Weight	30.5t

### Basic machine 2 ×1

Length (L)	7.20m
Width (W)	3.00m
Height (H)	3.35m
Weight	29.6t

### Basic machine 3 ×1

Length (L)	7.10m
Width (W)	3.00m
Height (H)	3.00m
Weight	17.2t

### Track frame ×2

Length(L)	5.63m
Width(W)	0.90m
Height(H)	0.98m
Weight	6.2t

### Boom base ×1

Length(L)	6.65m
Width(W)	1.39m
Height(H)	1.65m
Weight	0.95t

### Boom top ×1

Length(L)	7.10m
Width(W)	1.39m
Height(H)	1.48m
Weight	0.8t

## Transport Dimension

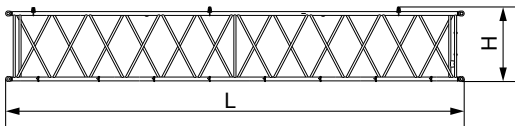

### 9m boom insert ×2

Length(L)	9.10m
Width(W)	1.39m
Height(H)	1.48m
Weight	0.65t

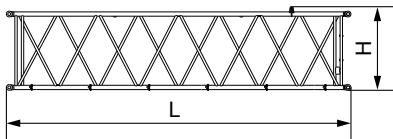

### 6m boom insert ×3

Length (L)	6.10m
Width (W)	1.39m
Height (H)	1.48m
Weight	0.45t

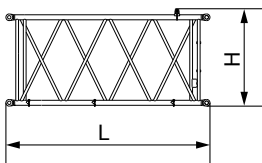

### 3m boom insert ×1

Length (L)	3.10m
Width (W)	1.39m
Height (H)	1.48m
Weight	0.28t

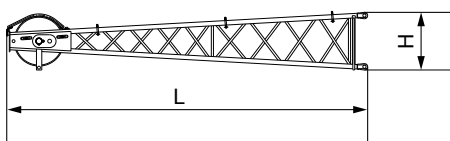

### Fixed jib top ×1

Length(L)	3.38m
Width(W)	0.70m
Height(H)	0.55m
Weight	0.15t

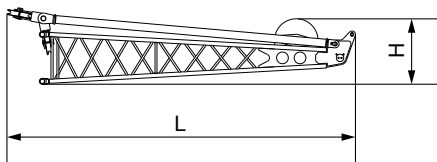

### Fixed jib base and strut ×1

Length(L)	3.57m
Width(W)	0.61m
Height(H)	0.78m
Weight	0.25t

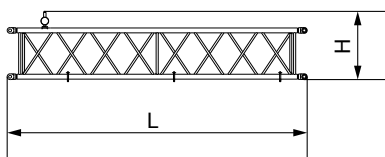

### 3.05m fixed jib insert ×3

Length(L)	3.11m
Width(W)	0.62m
Height(H)	0.70m
Weight	0.1t

## Transport Dimension

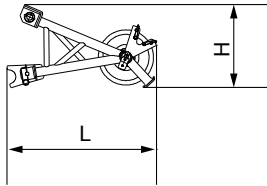

### Extension jib ×1

Length (L)	1.26m
Width (W)	0.71m
Height (H)	0.70m
Weight	0.12t

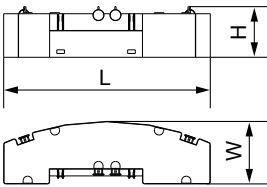

### Counterweight tray ×1

Length (L)	3.40m
Width (W)	0.98m
Height (H)	0.72m
Weight	4.4t

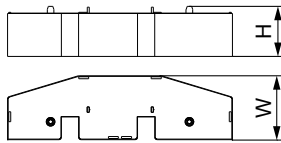

### Counterweight block I ×1

Length (L)	3.40m
Width (W)	0.98m
Height (H)	0.76m
Weight	5.7t

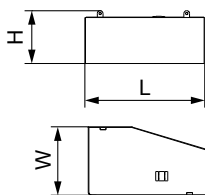

### Left counterweight block ×1

Length(L)	1.69m
Width(W)	0.97m
Height(H)	0.75m
Weight	3.0t

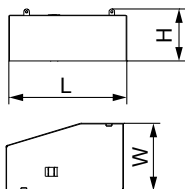

### Right counterweight block ×1

Length(L)	1.69m
Width(W)	0.97m
Height(H)	0.75m
Weight	3.0t

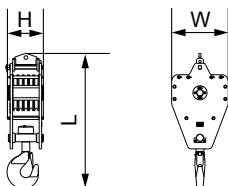

### 60t hook ×1

Length(L)	1.65m
Width(W)	0.69m
Height(H)	0.39m
Weight	0.65t

## Transport Dimension

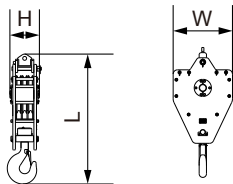

### 45t hook ×1

Length(L)	1.52m
Width(W)	0.69m
Height(H)	0.37m
Weight	0.48t

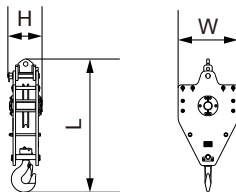

### 15t hook ×1

Length (L)	1.34m
Width (W)	0.60m
Height (H)	0.34m
Weight	0.28t

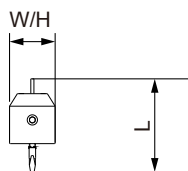

### 9t ball hook ×1

Length (L)	0.75m
Width (W)	0.30m
Height (H)	0.30m
Weight	0.18t

Note:

- ① . The transport dimensions of each part in the table are schematic, not proportional to the real parts. The dimensions are designed value without package considered.
- ② . The Weight is designed value that the actual manufactured part may deviate a little.

## Transport Plan

### Trailer 1

Part(s) ▪ Basic machine

Weight ▪ 30.5t

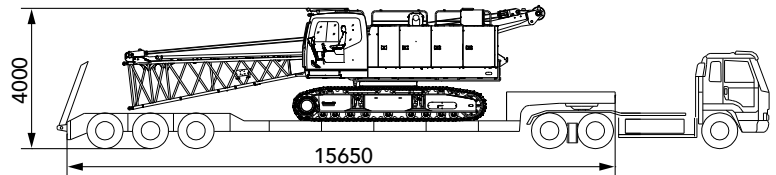

### Trailer 2

Part(s) ▪ 9m boom insert × 2  
 ▪ 6m boom insert × 3  
 ▪ 3m boom insert × 1  
 ▪ Boom top × 1  
 ▪ Extension jib × 1  
 ▪ 3.05m fixed jib insert × 3  
 ▪ Fixed jib base and strut × 1  
 ▪ Fixed jib top × 1  
 ▪ Counterweight tray × 1  
 ▪ Counterweight block I × 1  
 ▪ Left counterweight block × 1  
 ▪ Right counterweight block × 1  
 ▪ 60t hook × 1  
 ▪ 45t hook × 1  
 ▪ 15t hook × 1  
 ▪ 9t hook × 1

Weight ▪ 22 t

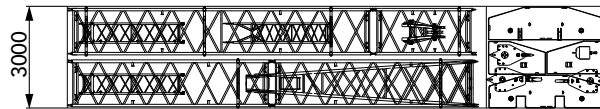
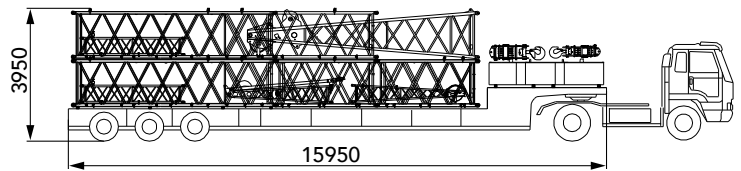





**SCC600A-6**  
**SANY CRAWLER CRANE**  
**60 TONS LIFTING CAPACITY**

QUALITY CHANGES THE WORLD

## Cofigurations

- Page 20 H Configuration
- Page 23 FJ Configuration

> 17

**Boom Combination**

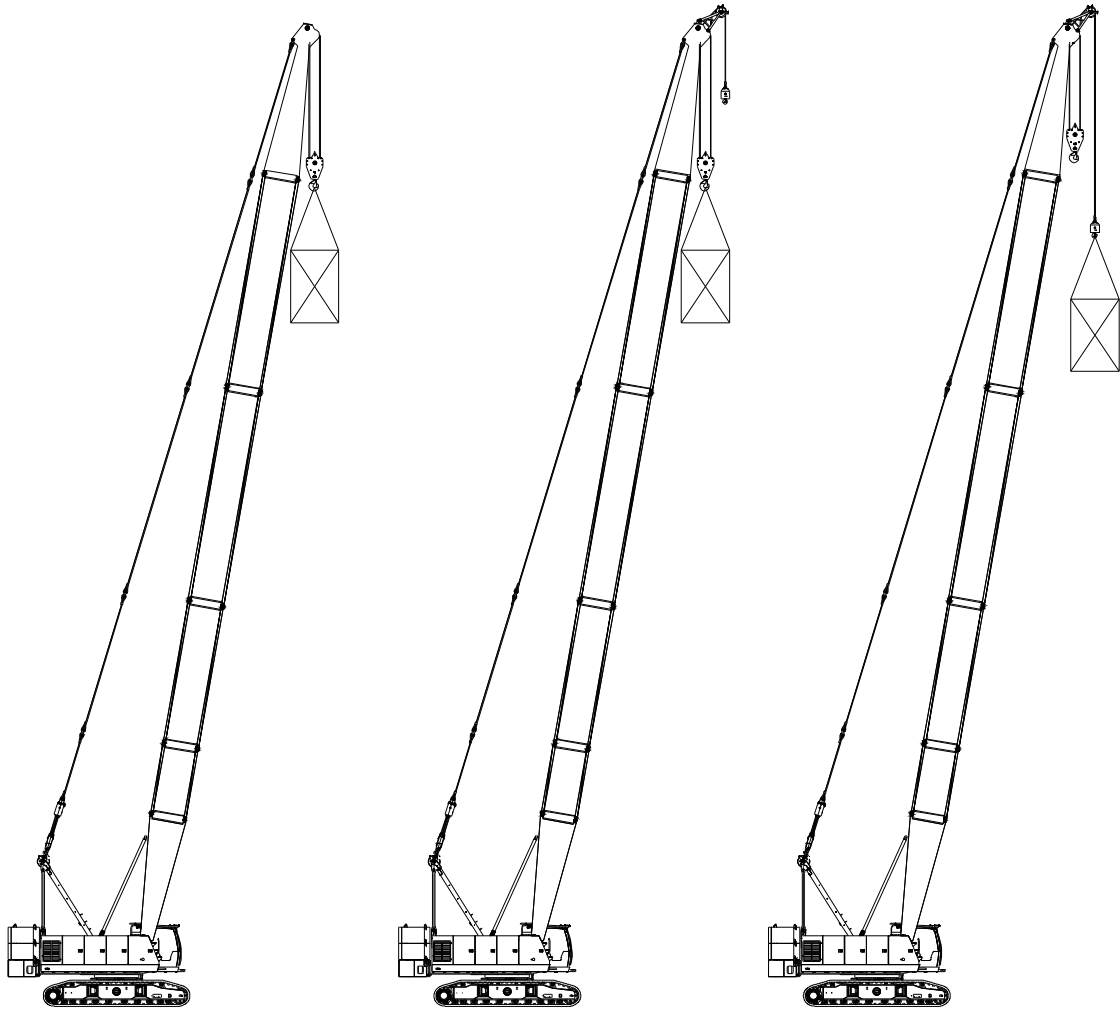

**H Configuration**

**HCm Configuration**  
(double hooks, load on main hook)

**HCa Configuration**  
(double hooks, load on aux. hook)

Configuration	Boom Combination	Boom Length
H	Boom	13m~52m
HCm	Boom + Extension jib (double hooks, load on main hook)	
HCa	Boom + Extension jib (double hooks, load on aux. hook)	

Notes: The schematics above are reference for loading only.

**Boom Combination**

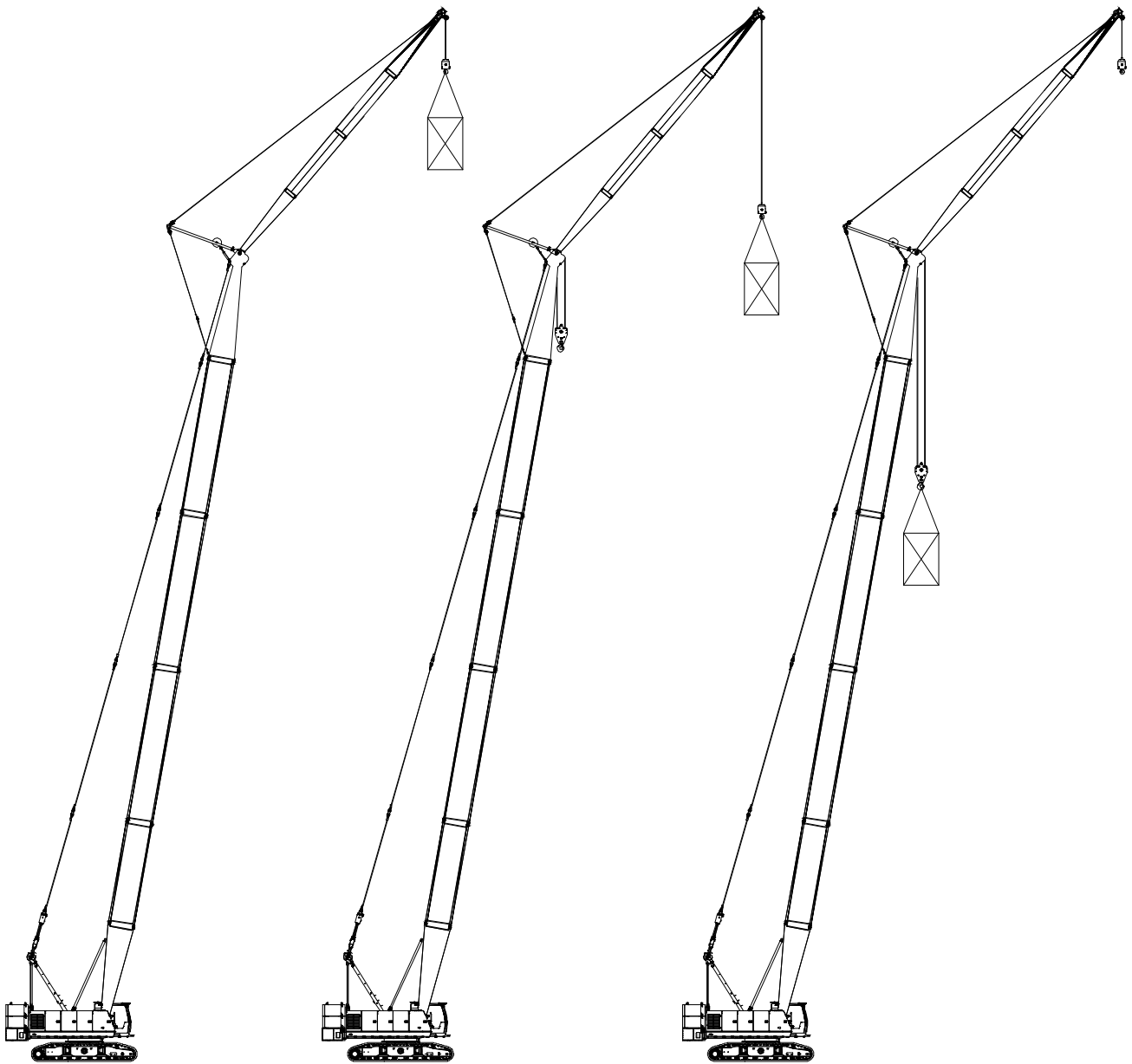

**FJ Configuration**  
(single hook)

**FJa Configuration**  
(double hooks, load on aux. hook)

**FJm Configuration**  
(double hooks, load on main hook)

Configuration	Boom Combination	Boom Length
FJ	Boom + Fixed Jib (single hook)	( 22m~43m)+( 6.1m~15.25m)
FJm	Boom + Fixed Jib (double hooks, load on main hook)	
FJa	Boom + Fixed Jib (double hooks, load on aux. hook)	

Notes: The schematics above are reference for loading only.

## H Configuration

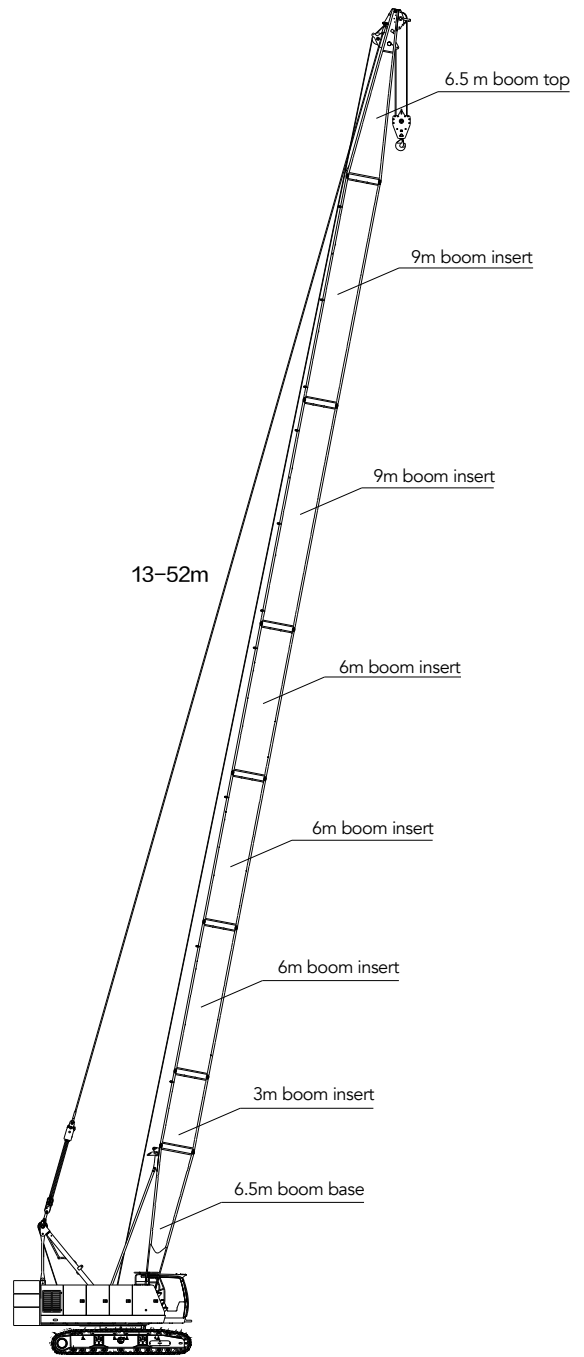
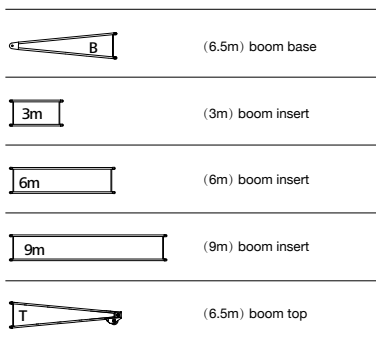
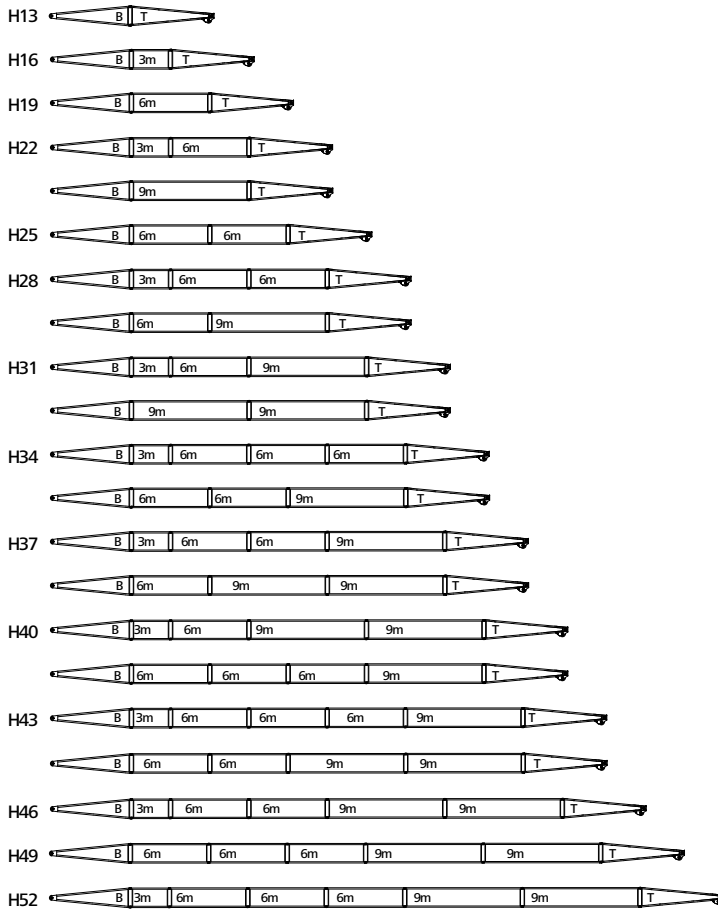

H Configuration

## Working Radius in H Configuration

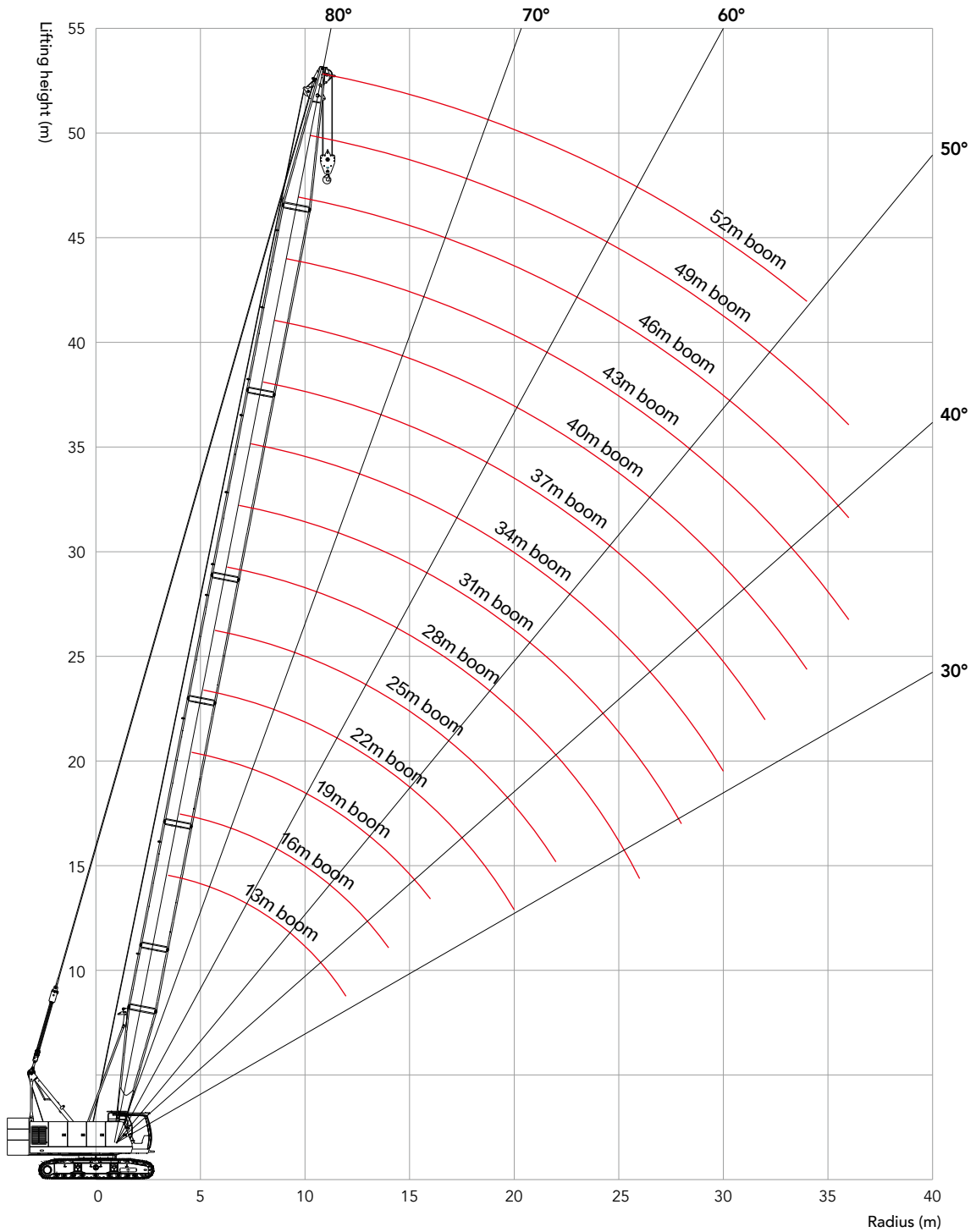

## Load Chart of H Configuration

H Configuration load chart															
Rear counterweight 16t															
Boom length(m) Radius(m)	13	16	19	22	25	28	31	34	37	40	43	46	49	52	Boom length(m) Radius(m)
3.7	60														3.7
4	50.2	48.2													4
4.5	42.5	41.8	40.2												4.5
5	37.5	36	35	33.2											5
5.5	32.5	31.9	31	30.2	28.2										5.5
6	28.5	28.3	27.5	27.2	26.2	25.2									6
7	22.9	22.7	22.5	22.2	21.7	21.2	20.5								7
8	19.2	19	18.7	18.5	18.5	18	17.5	17.1	16.7						8
9	16.1	15.7	15.7	15.6	15.5	15.4	14.8	14.2	14	13.2	12.8				9
10	14.2	14	13.9	13.9	13.7	13.7	13.5	13.2	12.8	12.5	12.1	11.7	11.3		10
12	11.3	11.2	11.1	11	10.9	10.8	10.8	10.5	10.3	10	9.6	9.3	9.2	9.2	12
14		9.3	9.2	9.1	9	8.8	8.8	8.6	8.5	8.2	8	7.7	7.4	7.4	14
16			7.8	7.7	7.6	7.5	7.4	7.2	7.1	6.9	6.9	6.6	6.4	6.2	16
18				6.6	6.5	6.5	6.4	6.2	6.1	5.9	5.8	5.5	5.3	5.1	18
20				5.6	5.6	5.5	5.5	5.3	5.2	4.9	4.9	4.7	4.4	4.3	20
22					4.8	4.8	4.6	4.5	4.3	4.2	4.1	3.9	3.7	3.6	22
24						4.2	4	3.9	3.7	3.6	3.5	3.3	3.2	3	24
26						3.6	3.6	3.4	3.3	3.2	3	2.9	2.7	2.5	26
28							3	3	2.9	2.7	2.5	2.4	2.3	2.1	28
30								2.6	2.5	2.3	2.1	2	1.9	1.7	30
32									2.1	2	1.8	1.7	1.6	1.4	32
34										1.7	1.5	1.4	1.3	1.2	34
36											1.1	1	0.9		36

Notes: Rated capacity of crawler crane:

- ① . The rated load in the load chart is calculated complying with GB/T 3811.
- ② . The rated capacity in the load charts is calculated when the crane is parking on firm and level ground and lifting the load slowly and steadily.
- ③ . The rated capacity values in the load charts are only valid when wind speed is lower than 9.8 m/s.
- ④ . The rated capacity in the load charts includes the weight of lifting hook, etc.; therefore, the actual rated capacity is the value after deducting the weight of lifting tools (such as lifting hook), from the rated load in the load charts.
- ⑤ . The crawlers must be extended during lifting.
- ⑥ . The values in the load charts are valid for 360° slewing.
- ⑦ . See Operation Manual for load charts of HCm and HCa configurations.

## FJ Configuration

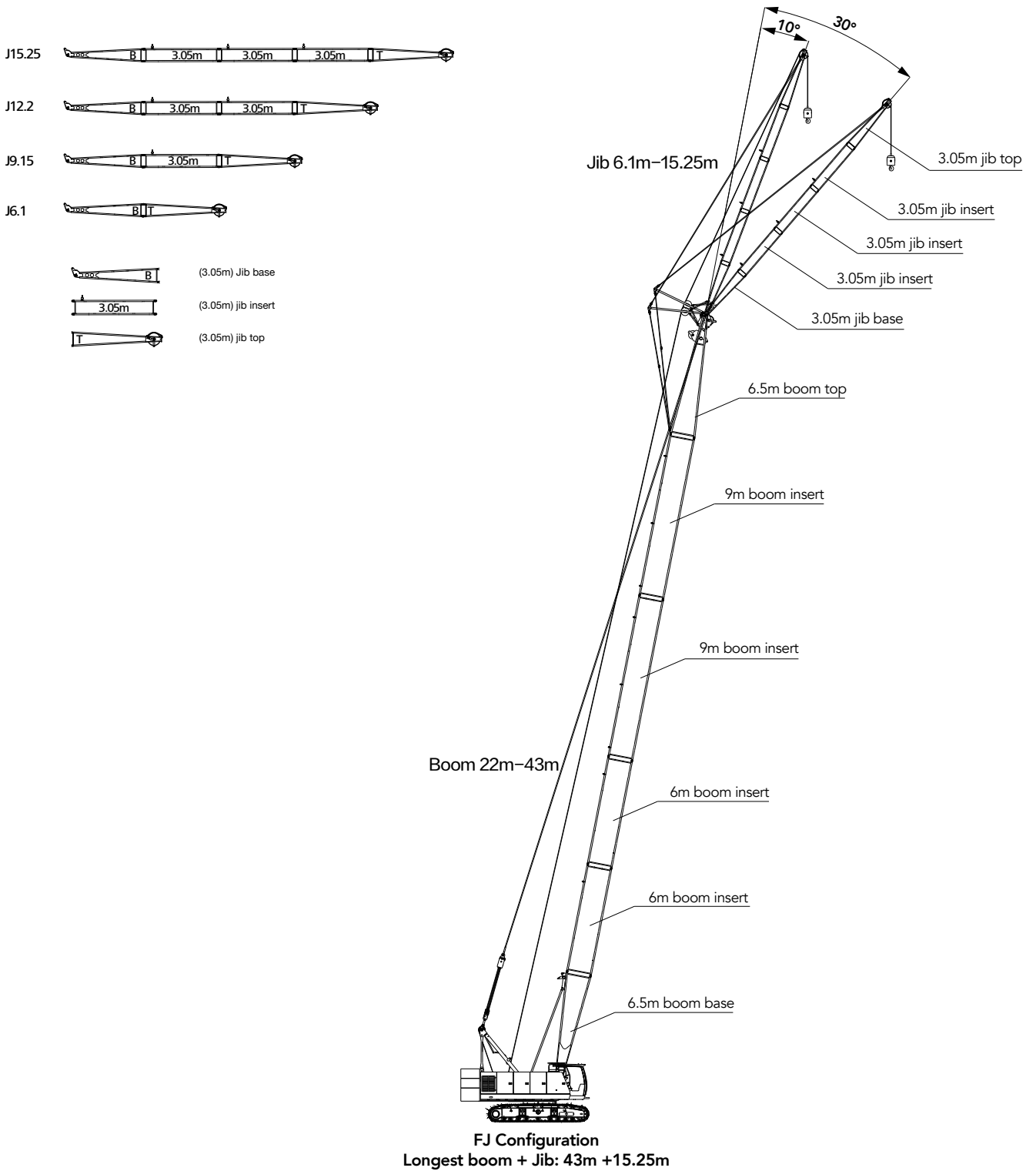

## Working Radius in FJ Configuration

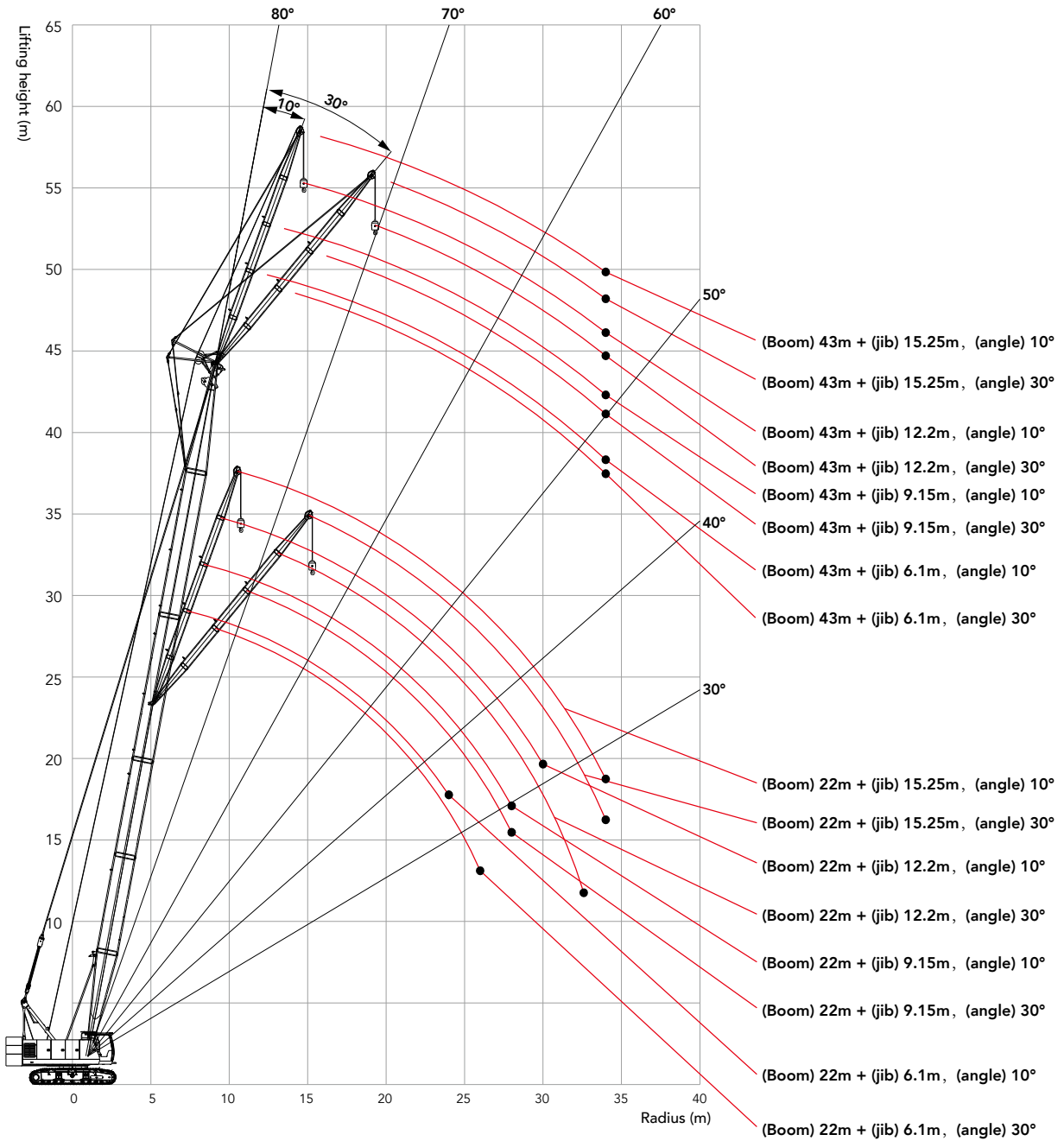



Unit: t

## Load Chart of FJ Configuration

FJ Configuration load chart(Fixed jib 6.1m~15.25m, Rear counterweight 16t) 1/8									
Boom 22m									
Jib length (m)	6.1		9.15		12.2		15.25		Jib length (m)
Jib angle Radius(m)	10°	30°	10°	30°	10°	30°	10°	30°	Jib angle Radius(m)
8	7.0	9.8m × 6.5	9.2m × 7						8
10	7.0	6.3	7.0		10.3m × 4.5		11.4m × 4.5		10
12	7.0	6.0	7.0	4.8	4.5		4.4		12
14	7.0	5.5	7.0	4.65	4.5	4.0	4.4		14
16	7.0	5.0	6.5	4.45	4.5	3.5	4.0	3.5	16
18	6.0	5.0	5.8	4.25	4.15	3.5	4.0	3.25	18
20	4.9	5.0	5.0	4.05	3.95	3.5	3.85	3.05	20
22	4.3	4.35	4.35	3.85	3.85	3.5	3.6	2.9	22
24	3.9	4.0	4.0	3.5	3.65	3.25	3.35	2.85	24
26		3.85	3.85	3.45	3.55	3.2	3.25	2.75	26
28			3.05	3.05	3.05	3.05	3.05	2.7	28
30					2.75	2.75	2.75	2.65	30
32						2.5	2.5	2.2	32
34						32.6m × 2.5	2.3	2.15	34
Counterweight(t)	16	16	16	16	16	16	16	16	Counterweight(t)

Note: Values shaded in dark gray are determined by strength of boom system.

FJ Configuration load chart(Fixed jib 6.1m~15.25m, Rear counterweight 16t) 2/8									
Boom 25m									
Jib length (m)	6.10		9.15		12.20		15.25		Jib length (m)
Jib angle Radius(m)	10°	30°	10°	30°	10°	30°	10°	30°	Jib angle Radius(m)
8	8.6m × 7								8
10	7.0	10.4m × 6	7.0		10.9m × 4.5				10
12	7.0	6.0	7.0	12.5m × 4.8	4.5		12.1m × 4.5		12
14	7.0	5.5	7.0	4.65	4.5	14.5m × 4.0	4.40		14
16	7.0	5.5	6.5	4.45	4.35	3.5	4.25	16.6m × 3.5	16
18	6.0	5.0	5.5	4.25	4.15	3.5	4.0	3.25	18
20	4.9	5.0	5.0	4.05	3.95	3.5	3.85	3.05	20
22	4.3	4.35	4.35	3.85	3.85	3.5	3.6	2.9	22
24	3.9	4.0	4.0	3.50	3.65	3.25	3.35	2.85	24
26	3.8	3.85	3.85	3.45	3.55	3.2	3.25	2.75	26
28	3.0	3.05	3.05	3.05	3.05	3.05	3.05	2.7	28
30			2.65	2.75	2.75	2.75	2.75	2.65	30
32				2.4	2.4	2.4	2.4	2.2	32
34						2.25	2.2	2.15	34

Note: Values shaded in dark gray are determined by strength of boom system.

## Load Chart of FJ Configuration

FJ Configuration load chart(Fixed jib 6.1m~15.25m, Rear counterweight 16t) 3/8

Boom 28m									
Jib length (m)	6.1		9.15		12.2		15.25		Jib length (m)
Jib angle Radius(m)	10°	30°	10°	30°	10°	30°	10°	30°	Jib angle Radius(m)
8	9.3m × 7								8
10	7.0	11.1m × 6	10.4m × 7		11.6m × 4.5				10
12	7.0	6.0	7.0	13.1m × 5.0	4.5		12.7m × 4.0		12
14	7.0	5.5	7.0	4.8	4.5	15.1m × 3.8	3.5		14
16	7.0	5.5	6.5	4.55	4.3	3.8	3.5	17.2m × 3.2	16
18	6.0	5.0	5.5	4.05	4.05	3.7	3.5	3.2	18
20	5.0	5.0	5.0	3.85	3.95	3.55	3.45	3.05	20
22	4.5	4.5	4.5	3.7	3.85	3.45	3.25	2.95	22
24	4.0	4.0	4.0	3.5	3.65	3.25	3.35	2.85	24
26	3.8	3.85	3.85	3.45	3.55	3.2	3.25	2.75	26
28	3.0	3.05	3.05	3.05	3.05	3.05	3.05	2.7	28
30	2.6	2.65	2.65	2.75	2.75	2.75	2.75	2.65	30
32	31.3m × 2.3		2.3	2.3	2.35	2.4	2.35	2.2	32
34			2.05	2.10	2.1	2.15	2.1	2.15	34

Note: Values shaded in dark gray are determined by strength of boom system.

FJ Configuration load chart(Fixed jib 6.1m~15.25m, Rear counterweight 16t) 4/8

Boom 31m									
Jib length (m)	6.10		9.15		12.20		15.25		Jib length (m)
Jib angle Radius(m)	10°	30°	10°	30°	10°	30°	10°	30°	Jib angle Radius(m)
10	7.0	11.7m × 6	11.0m × 7						10
12	7.0	6.0	7.0		12.2m × 4.5		13.3m × 4.0		12
14	7.0	5.5	7.0	4.75	4.5		4.0		14
16	7.0	5.5	6.5	4.5	4.5	4.0	4.0		16
18	6.0	5.5	5.5	4.35	4.35	3.85	4.0	3.2	18
20	4.8	4.85	4.85	4.25	4.15	3.7	3.85	3.15	20
22	4.4	4.45	4.45	4.05	3.95	3.5	3.65	3.0	22
24	4.0	4.05	4.05	3.85	3.8	3.35	3.45	2.85	24
26	3.8	3.85	3.85	3.45	3.55	3.2	3.25	2.75	26
28	3.0	3.05	3.05	3.05	3.05	3.05	3.05	2.7	28
30	2.6	2.65	2.65	2.75	2.75	2.75	2.75	2.65	30
32	2.2	2.25	2.25	2.25	2.35	2.35	2.3	2.3	32
34		1.95	1.95	2.0	2.0	2.1	2.05	2.15	34

Note: Values shaded in dark gray are determined by strength of boom system.

Unit: t

## Load Chart of FJ Configuration

FJ Configuration load chart(Fixed jib 6.1m~15.25m, Rear counterweight 16t) 5/8									
Boom 34m									
Jib length (m)	6.1		9.15		12.2		15.25		Jib length (m)
Jib angle	10°	30°	10°	30°	10°	30°	10°	30°	Jib angle
Radius(m)									Radius(m)
10	10.5m × 7.0		11.7m × 7.0						10
12	7.0	12.3m × 6	7.0		12.8m × 4.5		13.9m × 3.5		12
14	7.0	6.0	7.0	14.4m × 4.8	4.5		3.5		14
16	7.0	5.5	6.5	4.75	4.5	16.4m × 3.85	3.5		16
18	5.5	5.5	5.5	4.65	4.35	3.75	3.5	18.4m × 3.2	18
20	4.8	4.85	4.85	4.45	4.15	3.55	3.5	3.15	20
22	4.3	4.35	4.35	4.2	3.95	3.45	3.35	3.05	22
24	3.8	3.85	3.85	3.9	3.75	3.35	3.3	2.95	24
26	3.4	3.45	3.45	3.45	3.45	3.15	3.2	2.85	26
28	3.0	3.05	3.05	3.05	3.05	3.05	3.05	2.8	28
30	2.6	2.65	2.65	2.75	2.75	2.75	2.75	2.65	30
32	2.2	2.25	2.25	2.25	2.35	2.35	2.3	2.35	32
34	1.8	1.85	1.85	1.95	1.9	2.0	1.95	2.05	34

Note: Values shaded in dark gray are determined by strength of boom system.

FJ Configuration load chart(Fixed jib 6.1m~15.25m, Rear counterweight 16t) 6/8									
Boom 37m									
Jib length (m)	6.10		9.15		12.20		15.25		Jib length (m)
Jib angle	10°	30°	10°	30°	10°	30°	10°	30°	Jib angle
Radius(m)									Radius(m)
10	11.1m × 7								10
12	7.0	12.9m × 6	12.3m × 7		13.4m × 4.5				12
14	7.0	6.0	7.0	15.0m × 4.8	4.5		14.6m × 4.0		14
16	6.5	5.5	6.5	4.8	4.5	17.0m × 3.8	4.0		16
18	5.5	5.5	5.5	4.6	4.5	3.75	3.8	19.1m × 3.2	18
20	4.6	4.65	4.65	4.45	4.2	3.65	3.6	3.15	20
22	4.1	4.15	4.15	4.25	4.05	3.45	3.5	3.05	22
24	3.6	3.65	3.65	3.75	3.75	3.35	3.35	2.95	24
26	3.2	3.25	3.25	3.35	3.35	3.25	3.2	2.85	26
28	2.9	2.95	2.95	2.95	2.95	2.95	3.0	2.8	28
30	2.5	2.55	2.55	2.6	2.65	2.65	2.6	2.7	30
32	2.2	2.25	2.25	2.25	2.35	2.35	2.3	2.3	32
34	1.65	1.75	1.75	1.85	1.8	1.9	1.95	2.05	34

Note: Values shaded in dark gray are determined by strength of boom system.

## Load Chart of FJ Configuration

FJ Configuration load chart(Fixed jib 6.1m~15.25m, Rear counterweight 16t) 7/8

Boom 40m									
Jib length (m)	6.1		9.15		12.2		15.25		Jib length (m)
Jib angle	10°	30°	10°	30°	10°	30°	10°	30°	Jib angle
Radius(m)									Radius(m)
12	7.0	13.6m × 6	12.9m × 7						12
14	7.0	6.0	7.0	15.6m × 4.8	14.8m × 4.5		15.2m × 3.5		14
16	6.5	5.5	6.5	4.5	4.5		3.5		16
18	5.5	5.5	5.5	4.5	4.35	4.0	3.45	19.7m × 3.2	18
20	4.5	4.55	4.55	4.35	4.2	3.85	3.35	3.2	20
22	4.0	4.05	4.05	4.15	4.05	3.7	3.25	3.1	22
24	3.6	3.65	3.65	3.7	3.55	3.5	3.15	3.0	24
26	3.15	3.2	3.2	3.25	3.15	3.35	3.0	2.9	26
28	2.8	2.85	2.85	2.85	2.85	2.85	2.75	2.8	28
30	2.45	2.5	2.5	2.55	2.45	2.55	2.45	2.55	30
32	2.1	2.15	2.15	2.25	2.15	2.25	2.15	2.3	32
34	1.85	1.9	1.9	1.95	1.85	1.95	1.95	2.05	34

Note: Values shaded in dark gray are determined by strength of boom system.

FJ Configuration load chart(Fixed jib 6.1m~15.25m, Rear counterweight 16t) 8/8

Boom 43m									
Jib length (m)	6.10		9.15		12.20		15.25		Jib length (m)
Jib angle	10°	30°	10°	30°	10°	30°	10°	30°	Jib angle
Radius(m)									Radius(m)
12	12.4m × 7		13.5m × 7						12
14	7.0	14.2m × 6	7.0		14.7m × 4.5		15.8m × 3.5		14
16	7.0	5.5	6.5	16.2m × 4.8	4.5		16.8m × 3.5		16
18	5.5	5.5	5.5	4.8	4.35	19.3m × 3.8	3.35		18
20	4.45	4.5	4.5	4.5	4.2	3.8	3.25	20.3m × 3.2	20
22	3.95	4.0	4.0	4.2	4.05	3.7	3.15	3.15	22
24	3.5	3.55	3.55	3.65	3.55	3.5	3.05	3.05	24
26	3.1	3.15	3.15	3.15	3.1	3.2	2.85	2.95	26
28	2.7	2.75	2.75	2.75	2.75	2.85	2.75	2.85	28
30	2.4	2.45	2.45	2.35	2.35	2.5	2.4	2.55	30
32	2.0	2.05	2.05	2.1	2.05	2.15	2.05	2.25	32
34	1.7	1.75	1.75	1.85	1.75	1.90	1.75	2.05	34

Note: Values shaded in dark gray are determined by strength of boom system.

Notes: Rated capacity of crawler crane:

- The rated load in the load chart is calculated complying with GB/T 3811.
- The rated capacity in the load charts is calculated when the crane is parking on firm and level ground and lifting the load slowly and steadily.
- The rated capacity values in the load charts are only valid when wind speed is lower than 9.8 m/s.
- The rated capacity in the load charts includes the weight of lifting hook, etc.; therefore, the actual rated capacity is the value after deducting the weight of lifting tools (such as lifting hook), from the rated load in the load charts.
- The crawlers must be extended during lifting.
- The values in the load charts are valid for 360° slewing.
- See the Operation Manual for load chart of FJm and FJa configurations.





## Zhejiang Sany Equipment Co.,LTD

SANY Crawler Crane Industrial Park, No. 2188 Daishan Road, Wuxing District, Huzhou City,  
Zhejiang Province, P. R. China Zip 313028  
Consulting [sanycrane@sanygroup.com](mailto:sanycrane@sanygroup.com) (Crane BU) / [crd@sany.com.cn](mailto:crd@sany.com.cn) (IHQ)  
After-sales Service 0086-400 6098 318

**Reminder:**

Any change in the technical parameters and configuration due to product modification or upgrade may occur without prior notice.  
The machine in the picture may include additional equipment. This brochure is for reference only, and goods in kind shall prevail.  
Copyright at SANY. No part of this brochure may be copied or used for any purpose without written approval from SANY.

© Edited in December 2022

