



# SCC1350A-5

## Crawler Crane

### 135 Tons Lifting Capacity

Quality Changes the World



- Max. lifting moment:  $120 \times 6 = 720 \text{t.m}$
- Max. boom length: 76m
- Max. fixed jib combination: 61m+31m
- Max. luffing jib combination: 49m+52m

The parameters, pictures and standard/optional equipment are only for reference in this brochure, the actual machine is based on the effective price list and contract.



## Crawler Crane Series SCC1350A-5

P03

Main  
Characteristics

- Product Specification
- Safety Device

P09

Technical  
Parameters

- Major Performance & Specifications
- Outline Dimension
- Transport Dimensions
- Transport Plan

P19

Cofigurations

- H Configuration
- Hh Configuration
- FJ Configuration
- LJ Configuration



**SCC1350A-5**  
**SANY CRAWLER CRANE**  
**135 TONS LIFTING CAPACITY**

QUALITY CHANGES THE WORLD

## Main Characteristics

- Page 04 Product Specification
- Page 07 Safety Device



## Product Specification



### Engine

- Model: DCEC (Cummins China) QSL8.9-C325 Diesel engine;
- Type: 4-stroke, water-cooled, vertical in-line 6 cylinders, direct injection, turbo-charger, intercooler, complied with European Non-road Tier III Emission Standard and Chinese Non-road Tier III Emission Standard;
- Displacement: 8.9L;
- Rated power: 242kW/2100rpm;
- Operation power: 234kW/1800rpm;
- Max. Torque: 1385N·m/1500rpm;
- Starter: 24V-7.5kW;
- Radiator: fin type aluminum plate core;
- Air cleaner: Dry type system with main filter element, safety element and resistance indicator;
- Throttle: Grip type hand throttle, electrically-controlled;
- Fuel filter: Replaceable paper element;
- Batteries: Two 12V×180Ah capacity batteries, connected in series;
- Fuel tank capacity: 400L.

### Electrical Control System

- Self-developed SYIC-II integrated control system is adopted with higher integration, precise operation and reliable quality;
- Control system consists of power system, engine system, main control system, LMI system, auxiliary system and safety monitoring system. CAN BUS is used for data communication between controller, monitor and the engine;
- Monitor: the working parameters and status are shown on the monitor, such as the engine speed, fuel volume, engine oil pressure, servo pressure, engine working hours, lifting conditions and boom angle.

### Hydraulic System

- Main pumps: open variable displacement piston pumps of large displacement are adopted to provide oil supply for main actuators of main machine;
- Gear pump: dual gear pump for swing, radiator and control circuit;
- Control: main pump adopts electrically-controlled positive flow control; winch motor adopts limitless adjustable piston motor of variable displacement. The operating components are two cross hydraulic handle, one dual travel pedal control valve to control various actuators proportionally;
- Way of cooling: heat exchanger, fan core and multi-stage cooling;
- Filter: large flow, high precision filter, with bypass valve and transmitter, which can remind the user to replace the filter element in time;
- Max. pressure of system: 35 Mpa;
- Main/aux. load hoist and travel system: 35 Mpa;
- Swing system: 20 MPa;
- Control system: 4.5 Mpa;
- Hydraulic Tank Capacity: 460L.

### Main and Auxiliary Load Hoist Mechanism

- Main and aux. hoist winches are driven separately by motor via gearbox. Operating winch handle can control the winch to rotate to two directions, which are lifting and lowering of hook. Excellent inching function is equipped on the machine;
- Drums with fold-line grooves can ensure the wire rope reeved in order in multilayers;

#### Non free fall for main and aux. load hoist:

Main Hoisting Mechanism	Drum diameter	596mm
	Rope speed (1st layer)	0-102m/min
	Diameter of wire rope	26mm
	Main load hoist wire rope length	300m
	Rated single line pull	13.5t
Auxiliary Hoisting Mechanism	Drum diameter	596mm
	Rope speed (1st layer)	0-102m/min
	Diameter of wire rope	26mm
	Aux. load hoist wire rope length	260m
	Rated single line pull	13.5t



## Product Specification

### Free fall for main/aux. load hoist:

Main hoisting mechanism	Drum diameter	576mm
	Rope speed (1st layer)	0~102m/min
	Wire rope diameter	26mm
	Main hoist wire rope length	300mm
	Rated single line pull	12t
Aux. hoisting mechanism	Drum diameter	576mm
	Rope speed (1st layer)	0~102m/min
	Wire rope diameter	26mm
	Aux. hoist wire rope length	260mm
	Rated single line pull	12t

### Boom Hoist Mechanism

- Boom hoist winch is driven directly by motor via gearbox. Operating winch handle can control the winch to rotate to two directions, which are lifting and lowering of boom;
- Drums with fold-line grooves can ensure the wire rope reeved in order in multilayers.

Boom hoist mechanism	Drum diameter	420mm
	Rope speed (1st layer)	0~45m/min
	Diameter of wire rope	20mm
	Boom hoist wire rope length	190m

### Swing Mechanism

- Swing brake adopts wet, spring loaded, normally-closed brake, and braking through spring force;
- Swing system, has free slipping function. It is featured in steady starting and control, and excellent inching function. Unique swing buffer design and steadier brake;
- Swing drive: external engaged swing drive with 360° swing range, and the max. swing speed is 1.5r/min. The max. drive pressure can reach 20MPa;
- Swing ring: three-row roller bearing.

### Cab and Control

- Novel operator's cab with fashionable profile, nice interior and large window glass, which can tilt up by 20° to provide panorama view. There are low and high-beam lights, back-view mirror, heater and A/C, radio and other functions. The layout of seat, handles, control buttons are designed with ergonomic principles to make operation more comfortable;
- Cab layout: Integrated 10.4-inch touch screen, programmable smart switches, and man-machine interaction interface are more perfect;
- Armrest box: on the left and right armrest box are control handles, electrical switches, emergent stop and ignition switch. The armrest box can be adjusted along with the seat;
- Seat: multi-way and multi-level floating adjustable seat with unload switch;
- A/C: cool and heat air; optimized air channels and vents;
- Multiple cameras can present on the monitor at the same time to realize backing video, real-time monitoring of wire rope on each winch, conditions behind the counterweight and surrounding the machine.

### Counterweight

- The stacking mode of counterweight tray and blocks is used for easy assembly, disassembly and transportation;
- Rear counterweight: total weight 55.3t. There are two types, the standard offering is self-assembled counterweight, and the optional offering is regular counterweight;
- The standard self-assembled counterweight: tray 12t×1, counterweight blocks 5.25t×8, self-assembled cylinder bracket 1.3t×1;
- The optional counterweight: tray 12.7t×1 counterweight blocks 7.1t×6;
- Carbody counterweight: A total of 2, total weight of 20t (10t×2).

### Upperworks

- High-strength steel weld framework, with no torsion or deformation. The parts are laid out in the way that is easier for maintenance and service.

## Product Specification



### Lowerworks

- Independent travel driving units are adopted for each side of the crawler, to realize straight walking and turning driven by travel motor through gearbox and drive wheel.

### Crawler Tightening

- The jack is used to push the guide wheel and insert the shim to adjust crawler tension.

### Track Pad

- High strength alloy cast steel track pad ensure long service life;
- They are 950mm wide with a quantity of 63 pads x 2.

### Operating Equipment

- All chords are high-strength steel tubes, and the boom/jib top sheaves are made of high-strength anti-wearing Nylon material protecting wire rope. The hooks are installed with milled welded steel sheave.

### Boom

- Lattice structure. The chord adopts high-strength structural tube and each section is connected through pins;
- Basic boom: 8m boom base + 8m boom top;
- Boom insert: 3m x 1, 6m x 2, 9m x 5;
- Boom length: 16m~76m.

### Fixed Jib

- Lattice structure. The chord adopts high-strength structural tube and each section is connected through pins;
- Basic jib: 5m jib base + 3m insert + 5m jib top;
- Jib insert: 6m x 3;
- Fixed jib: 13m~31m;
- Longest boom + jib: 61m + 31m.

### Luffing Jib

- Lattice structure. The chord adopts high-strength structural tube and each section is connected through pins;
- Basic jib: 6.5m jib base + 9m insert + 6.5m jib top;
- Jib insert: 3m x 2, 6m x 1, 9m x 2;
- Luffing jib length: 22m~ 52m;
- Longest boom + jib: 49m+52m.

### Extension Jib

- The welding structure is connected with main boom through hinge pin, and used for aux. hook operation;
- Length of extension boom: 2.7m.

### Hook Block

- 135t hook, 5 pulleys;
- 80t hook, 3 pulleys;
- 35t hook, 1 pulley;
- 13.5t ball hook.

### Hook Limitation Height

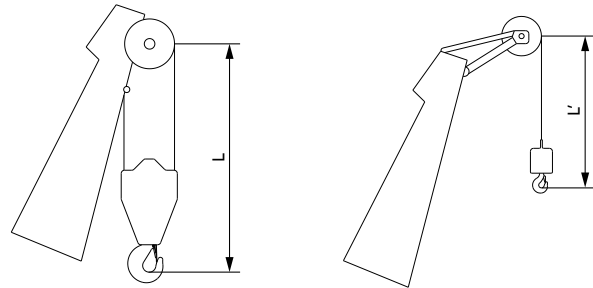

Hook	L
135t	3.8m
80t	3.9m
35t	3.6m

Hook	L'
13.5t	3.1m



## Safety Device

### Assembly/Work Mode Control Switch

- Under the assembly mode, over-hoist limit switch, crane boom limit device and load moment limiter do not work, so as to facilitate the installation of crane;
- All safety limit devices work in the work mode.

### Emergency Stop

- In emergent situation, this button is pressed down to cut off the power supply of whole machine and all actions stop.

### Load Moment Limiter (LMI)

- It is an independent computerized safety control system. LMI can automatically detect the load weight, work radius and boom angle, and present on the display the rated load, actual load, work radius and boom angle. In normal operation, the LML can make a judgment and cut off automatically if the crane moves towards dangerous direction. It can also perform as a black box to record the lifting information;
- It is composed of monitor, angle sensor and force sensor and other parts.

### Over-hoist Limit Switch of Main/Auxiliary Hooks

- Over-hoist protection device comprises of limit switch and weight on boom top, which prevents the hook lifting up too much;
- When the hook lifts up to the limit height, the limit switch activates, buzzer on the left control panel sends alarm, failure indicator light starts to flash, and the hook hoisting action is cut off automatically.

### Over-release Limit Switch of Main/Auxiliary Hooks

- It is comprised of activator in the drum and proximity switch to prevent over release of wire rope. When the rope is paid out close to the last three wraps, the limit switch acts, and the system sends alarm through buzzer and show the alarm on the instrument panel, automatically cutting off the winch action.

### Function Lock Lever

- If the function lock lever is not in work position, all the other handles won't work, which prevents any mis-operation caused by accidental collision.

### Boom Hoist Drum Lock

- Pawl lock is used on boom hoist winch, which needs to unlock by switch before operation, in order to prevent mis-operation of handles and ensure safety during nonwork time.

### Swing Lock Device

- Swing Lock can lock the machine at four positions, front and back, left and right.

### Boom Limit Device

- When the boom elevation angle reaches the max. set limit, the buzzer sounds and boom action cut off. This protection is two-stage control ensured by both LML system and travel switch;

### Back-stop Device

- Its major components are nesting tubes and spring, in order to buffer the boom backlash and prevent further tipping back.

### Boom Angle Indicator

- Pendulum angle indicator is fixed on the side of boom base close to the cab, so as to provide convenience to the operator.

### Hook Latch

- The hook is provided with a baffle to prevent wire rope from falling off.

## Safety Device



### Lightning Protection Device

- It is offered as an optional feature, which includes the grounding device that can effectively protect the electric system elements and workers from lightning.

### Tri-color Load Indicator

- The load indication light has three colors, green, yellow and red, and the real time load status is presented on the display. When the actual load is smaller than 90% of rated load, the green light is on;
- When the actual load is larger than 90% and smaller than 100%, the yellow light is on, the alarm light flashes and sends out intermittent sirens;
- When the actual load reaches 100% of rated load, the red light is on, the alarm light flashes and sends out continuous sirens;
- When the actual load reaches 102% of rated load, the system will automatically cut off the crane operation in dangerous trend.

### Audio-visual Alarm

- When the engine is working, the light flashes; when the machine is traveling or swinging, it sends out sirens.

### Swing Indicator Light

- The swing indicator light flashes during traveling or swing.

### Illuminating Light

- The machine is equipped with the low beam light and high beam light at the front of the cab, illumination light at cab, and other night lights, boom lights to improve the visibility during construction.

### Camera

- Set on the handrail at the front of right sheet metal, so as to monitor the rear part of machine.

### Pharos

- Pharos is mounted on the top of boom/jib to indicate the height.

### Anemometer

- It is mounted on the top of boom/jib, and displayed on the monitor in the cab.

### Electronic Level Indicator

- It displays the tipping angle of crane on the monitor in real time, protecting the machine from dangerous situation.

### Seat Interlock

- Put down the function lock lever on the left side of cab seat or if the operator leaves the seat, all control levers will be deactivated to prevent any mis-operation due to accidental collision.

### Engine Power Limit Load Adjustment and Stalling Protection

- The controller monitors the engine power to prevent engine getting stuck and stalling.

### Engine Status Monitoring

- The engine status will be presented, such as engine coolant temperature, fuel volume, total work hours, engine oil pressure, engine speed, battery charging, voltage.





**SCC1350A-5**  
**SANY CRAWLER CRANE**  
**135 TONS LIFTING CAPACITY**

QUALITY CHANGES THE WORLD

## Technical Parameters

- Page 10 Major Performance Specifications
- Page 11 Outline Dimension
- Page 12 Transport Dimensions
- Page 17 Transport Plan

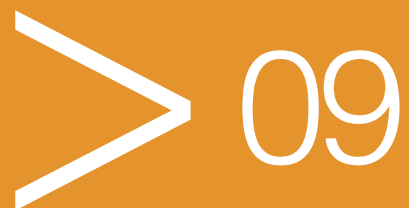

## Major Performance Specifications

Major Performance & Specifications of SCC1350A-5			
Performance Indicators		Unit	Parameter
Boom configuration	Maximum rated lifting capacity	t	135
	Maximum rated lifting moment	t·m	720(=120×6)
	Boom length	m	16~76
Fixed jib configuration	Maximum rated lifting capacity	t	27
	Jib length	m	13~31
	Longest main boom + jib	m	61+31
Luffing jib configuration	Maximum rated lifting capacity	t	40
	Jib length	m	22~52
	Longest main boom + jib	m	49+52
Operation speed	Rope speed of main/aux. load hoist (1st layer)	m/min	0~102
	Boom hoist winch rope speed (1st layer)	m/min	0~45
	Slewing speed	rpm	0~1.5
	Travelling speed	km/h	0~1.1
Engine	Output power	kW	242
	Rated speed	rpm	2100
Transport parameter	Weight of machine with basic boom (including, extension jib, jib luffing winch, 135t hook and 13.5t hook)	t	144.93
	Max. transport weight of basic machine (with standard self-assembled counterweight and boom base, jib puffing winch)	t	38.57
	Maximum transport dimension of basic machine (L x W x H, mm)	mm	15960x3000x3330
Other parameters	Average ground bearing pressure	MPa	0.112
	Grade ability	%	30

Unit:mm

### Outline Dimension

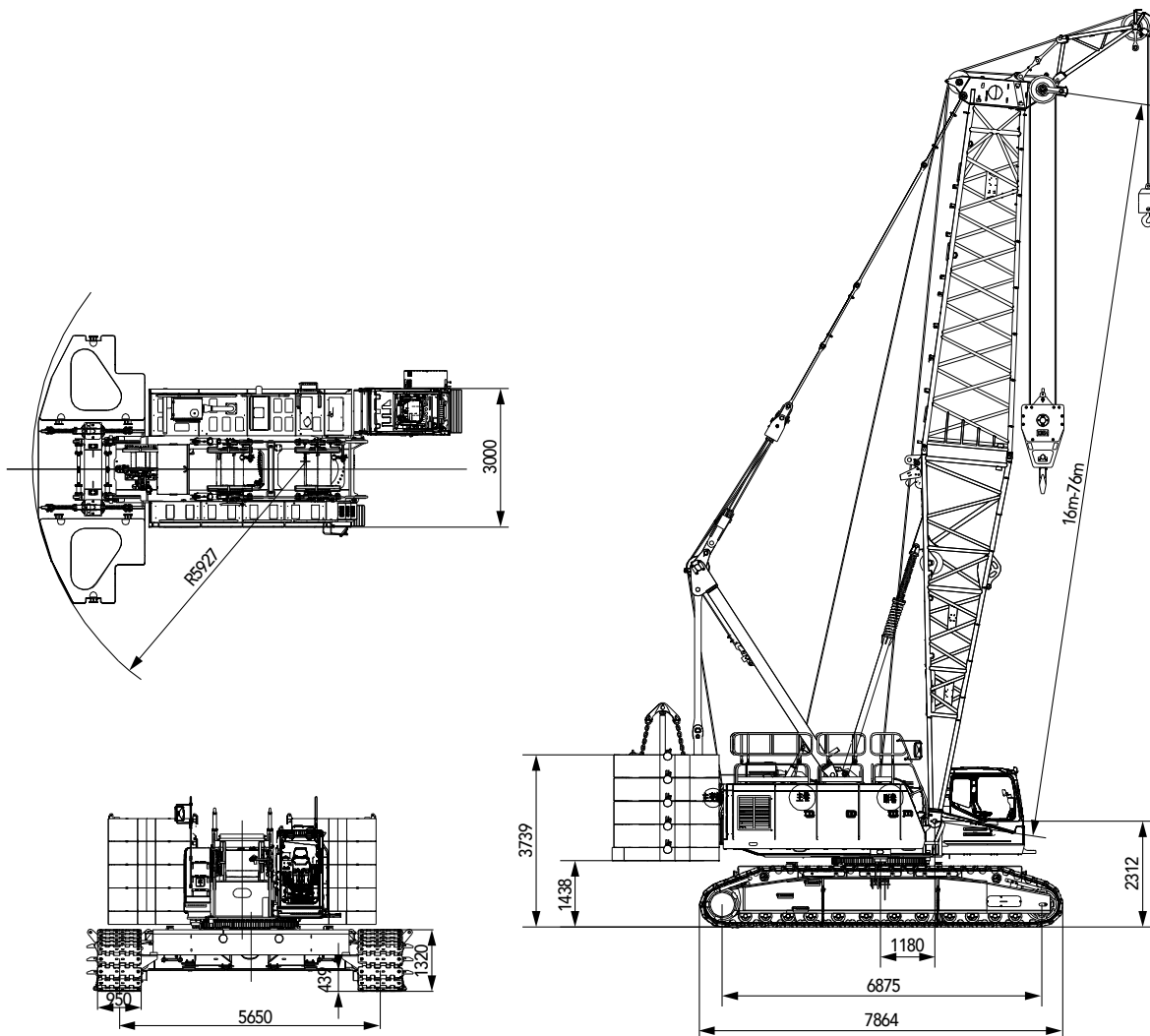

Note: this is regular counterweight for standard offering.

## Transport Dimensions

### Remarks:

- 1.The transport dimensions for the parts are for reference that do not draw to the scale. The dimensions listed above are deisnged values excluding packing.
- 2.Weight is design values. It maybe different due to manufacturing tolerances.

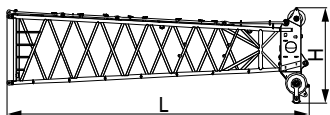
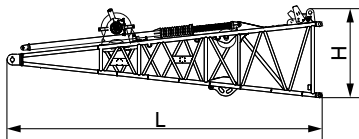
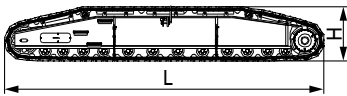
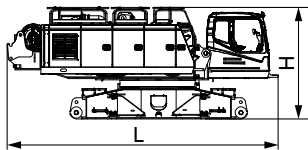
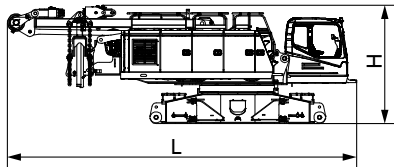
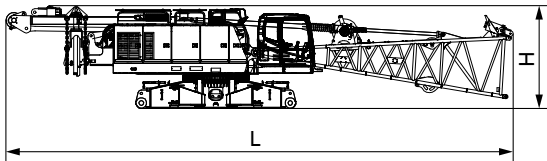

### Base machine (Mode 1, including boom base and jib luffing winch) ×1

Length(L)	15.96m
Width(W)	3.00m
Height(H)	3.33m
Weight	38.57t

Note: the weight of jib luffing winch and wire rope is 1.88t

### Base machine (Mode 2) ×1

Length(L)	10.01m
Width(W)	3.00m
Height(H)	3.33m
Weight	33.03t

### Base machine (Mode 3) ×1

Length(L)	7.71m
Width(W)	3.00m
Height(H)	3.20m
Weight	28.13t

Note: The above three modes are machines with regular rear counterweight (non self-assembly).

### Crawler Assembly ×2

Length(L)	7.83m
Width(W)	1.32m
Height(H)	1.32m
Weight	14.2t

### Boom base(including jib luffing winch) ×1

Length(L)	8.20m
Width(W)	2.08m
Height(H)	2.34m
Weight	5.61t

Note: the weight of jib luffing winch and wire rope is 1.88t.

### Boom top ×1

Length(L)	8.41m
Width(W)	1.95m
Height(H)	2.66m
Weight	2.35t

## Transport Dimensions

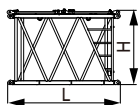

### 3m insert of main boom

×1

Length(L)	3.12m
Width(W)	1.95m
Height(H)	2.08m
Weight	0.63t

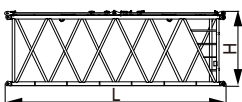

### 6m insert of main boom

×2

Length(L)	6.12m
Width(W)	1.95m
Height(H)	2.08m
Weight	1.04t

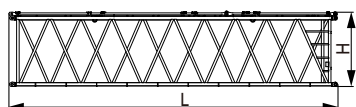

### 9m insert of main boom

×5

Length(L)	9.12m
Width(W)	1.95m
Height(H)	2.08m
Weight	1.49t

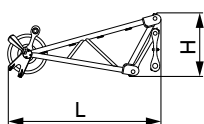

### Boom extension

×1

Length(L)	2.36m
Width(W)	1.04m
Height(H)	0.98m
Weight	0.31t

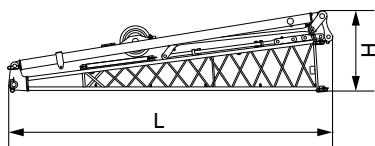

### Fixed jib base(including strut)

×1

Length(L)	5.25m
Width(W)	1.19m
Height(H)	1.30m
Weight	0.84t

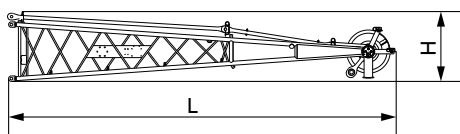

### Fixed jib top

×1

Length(L)	5.43m
Width(W)	1.01m
Height(H)	0.99m
Weight	0.53t

## Transport Dimensions

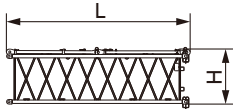

### 3m insert of fixed jib

×1

Length(L)	3.12m
Width(W)	1.02m
Height(H)	0.92m
Weight	0.19t

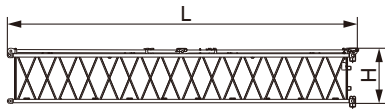

### 6m insert of fixed jib

×3

Length(L)	6.12m
Width(W)	1.02m
Height(H)	0.92m
Weight	0.34t

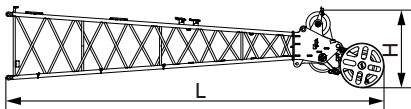

### Luffing jib top(with jib extension)

×1

Length(L)	7.81m
Width(W)	1.38m
Height(H)	1.45m
Weight	1.17t

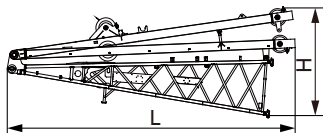

### Luffing jib base (with struts)

×1

Length(L)	7.26m
Width(W)	1.87m
Height(H)	2.70m
Weight	3.13t

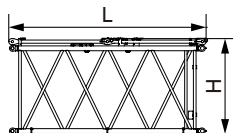

### 3m luffing jib insert

×2

Length(L)	3.10m
Width(W)	1.40m
Height(H)	1.50m
Weight	0.3t

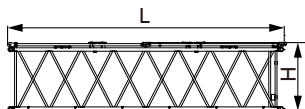

### 6m luffing jib insert

×1

Length(L)	6.10m
Width(W)	1.40m
Height(H)	1.50m
Weight	0.49t

## Transport Dimensions

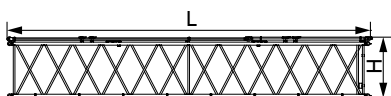

### 9m luffing jib insert

×3

Length(L)	9.10m
Width(W)	1.40m
Height(H)	1.60m
Weight	0.7t

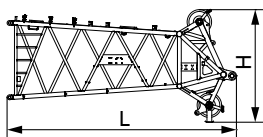

### Boom top (for LJ only)

×1

Length(L)	5.70m
Width(W)	1.95m
Height(H)	2.80m
Weight	1.9t

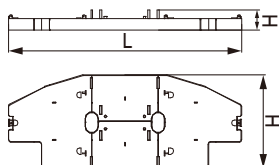

### Counterweight tray (self-assembly for standard offering)

×1

Length(L)	5.80m
Width(W)	2.31m
Height(H)	0.50m
Weight	12.0t

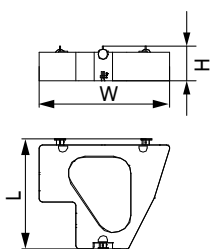

### Counterweight block (self-assembly for standard offering)

(1+1)×4

Length(L)	1.93m
Width(W)	2.28m
Height(H)	0.60m
Weight	5.25t

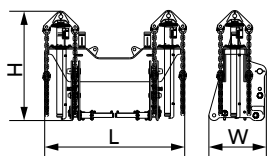

### Counterweight Cylinder, Bracket, Chain (self-assembly for standard offering)

1

Length(L)	2.15m
Width(W)	0.88m
Height(H)	1.68m
Weight	2.1t

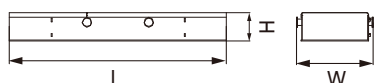

### Carbody counterweight

×2

Length(L)	4.25m
Width(W)	1.50m
Height(H)	0.55m
Weight	10.0t

## Transport Dimensions

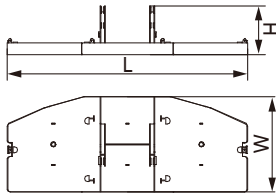

### Counterweight tray for regular counterweight of optional offering ×1

Length(L)	5.80m
Width(W)	2.31m
Height(H)	1.18m
Weight	12.7t

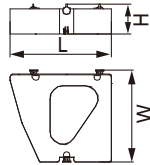

### Counterweight blocks for regular counterweight of optional offering (1+1)×3

Length(L)	2.31m
Width(W)	2.09m
Height(H)	0.59m
Weight	7.1t

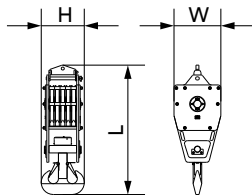

### 135t lifting hook ×1

Length(L)	2.28m
Width(W)	0.91m
Height(H)	0.69m
Weight	2.04t

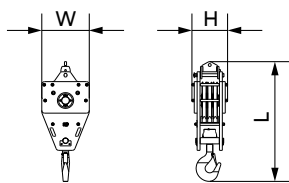

### 80t lifting hook ×1

Length(L)	2.21m
Width(W)	0.91m
Height(H)	0.62m
Weight	1.94t

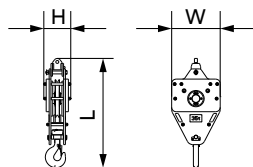

### 35t lifting hook ×1

Length(L)	1.88m
Width(W)	0.91m
Height(H)	0.46m
Weight	1.11t

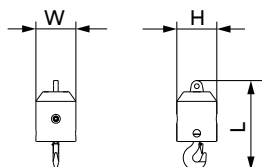

### 13.5t ball hook ×1

Length(L)	0.95m
Width(W)	0.43m
Height(H)	0.43m
Weight	0.45t



## Transport Plan

### Transport with crawler frame

Transport cart 1	
Components included	<ul style="list-style-type: none"> <li>Basic machine (4 winches, carbody, outrigger, A-frame, all wire ropes), boom base</li> </ul>
Transport weight	38.57t

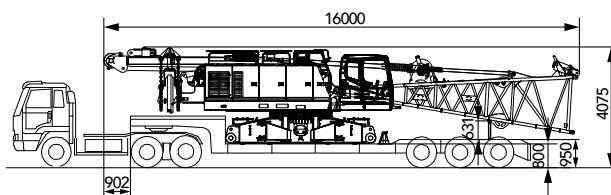

Transport cart 2	
Components included	<ul style="list-style-type: none"> <li>Crawler frame×2: 28.4t</li> <li>6m boom insert×1: 1.04t</li> <li>Packing Case×1: 1t</li> <li>6m luffing jib insert×1: 0.49t</li> </ul>
Transport weight	30.93t

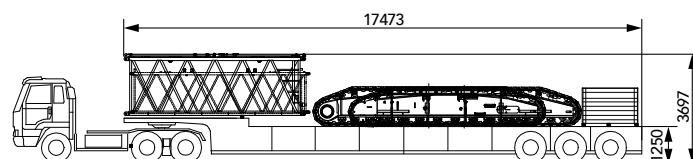

Transport cart 3	
Components included	<ul style="list-style-type: none"> <li>Counterweight tray for self-assembly counterweight×1: 12t</li> <li>Self-assembly counterweight×1: 5.25t</li> <li>Boom top×1: 2.35t</li> <li>135t hook×1: 2.04t</li> <li>Boom top (for LJ only)×1: 1.9t</li> </ul>
Transport weight	23.78t

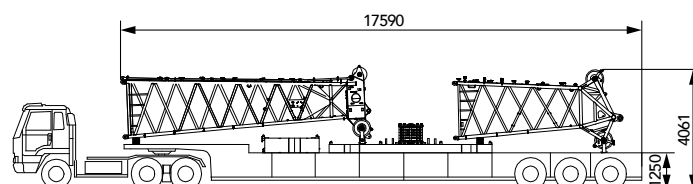

Transport cart 4	
Components included	<ul style="list-style-type: none"> <li>Self-assembly counterweight×3: 15.75t</li> <li>9m main boom×2: 2.98t</li> <li>6m fixed jib×1: 0.34t</li> <li>Fixed jib top×1: 0.53t</li> <li>Jib rear pendant bar×1: 0.15t</li> <li>35t lifting hook×1: 1.2t</li> <li>13.5t lifting hook×1: 0.45t</li> <li>9m luffing jib insert×1: 0.7t</li> <li>3m luffing jib insert×1: 0.3t</li> </ul>
Transport weight	22.4t

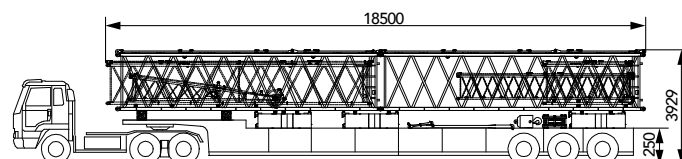

Transport cart 5	
Components included	<ul style="list-style-type: none"> <li>Self-assembly counterweight×4: 21t</li> <li>9m main boom×2: 2.98t</li> <li>6m fixed jib×2: 0.67t</li> <li>80t lifting hook×1: 1.94t</li> <li>9m luffing jib insert×1: 0.7t</li> <li>3m luffing jib insert×1: 0.3t</li> </ul>
Transport weight	27.59t

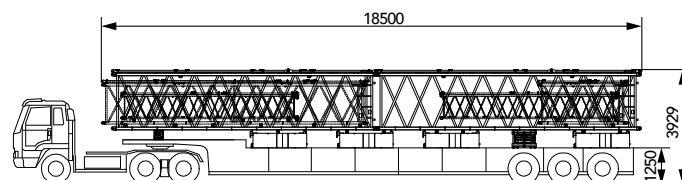

## Transport Plan

### Transport cart 6

- |                     |   |
|---------------------|---|
| Components included | <ul style="list-style-type: none"> <li>▪ Carbody counterweight×2: 20t</li> <li>▪ 9m boom insert×1: 1.49t</li> <li>▪ 6m boom insert×1: 1.04t</li> <li>▪ 3m boom insert×1: 0.63t</li> <li>▪ Fixed jib base×1: 0.84t</li> <li>▪ 3m fixed jib×1: 0.19t</li> <li>▪ 9m luffing jib insert×1: 0.7t</li> <li>▪ extension jib×1: 0.3t</li> </ul> |
|---------------------|---|

- |                  |  |
|------------------|--|
| Transport weight | <ul style="list-style-type: none"> <li>▪ 25.19t</li> </ul> |
|------------------|--|

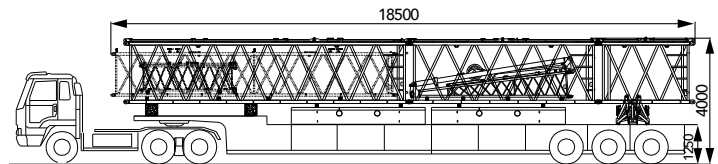

### Transport cart 7

- |                     |   |
|---------------------|---|
| Components included | <ul style="list-style-type: none"> <li>▪ Luffing jib base(with struts)×1: 3.13t</li> <li>▪ Luffing jib top (with jib extension)×1: 1.17t</li> </ul> |
|---------------------|---|

- |                  |  |
|------------------|--|
| Transport weight | <ul style="list-style-type: none"> <li>▪ 4.3t</li> </ul> |
|------------------|--|

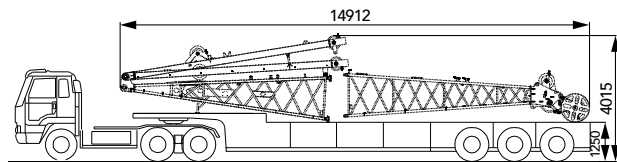

Transport plan for machine with regular counterweight of standard offering.



**SCC1350A-5**  
**SANY CRAWLER CRANE**  
**135 TONS LIFTING CAPACITY**

QUALITY CHANGES THE WORLD

## Cofigurations

- Page 23 H Configuration
- Page 30 Hh Configurations
- Page 33 FJ Configuration
- Page 39 LJ Configuration

> 19

**Boom Combination**

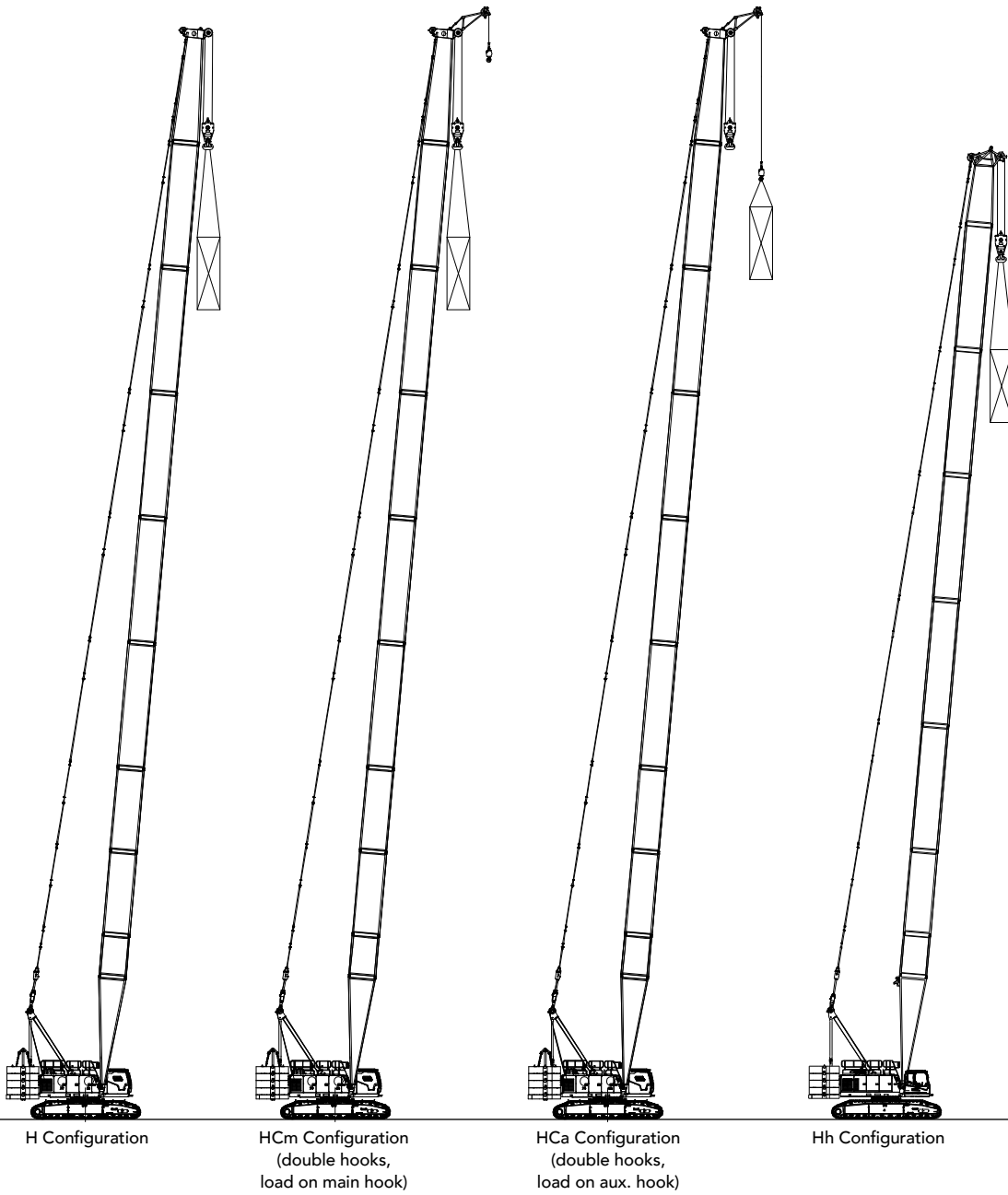

Configuration	Boom Combination	Boom Length
H	Boom	16m~76m
HCm	Boom + Extension jib (double hooks, load on main hook)	
HCa	Boom + Extension jib (double hooks, load aux. hook)	
Hh	Boom (with boom top special for LJ)	22m~67m

Note: The schematics above are reference for loading only.

## Boom Combination

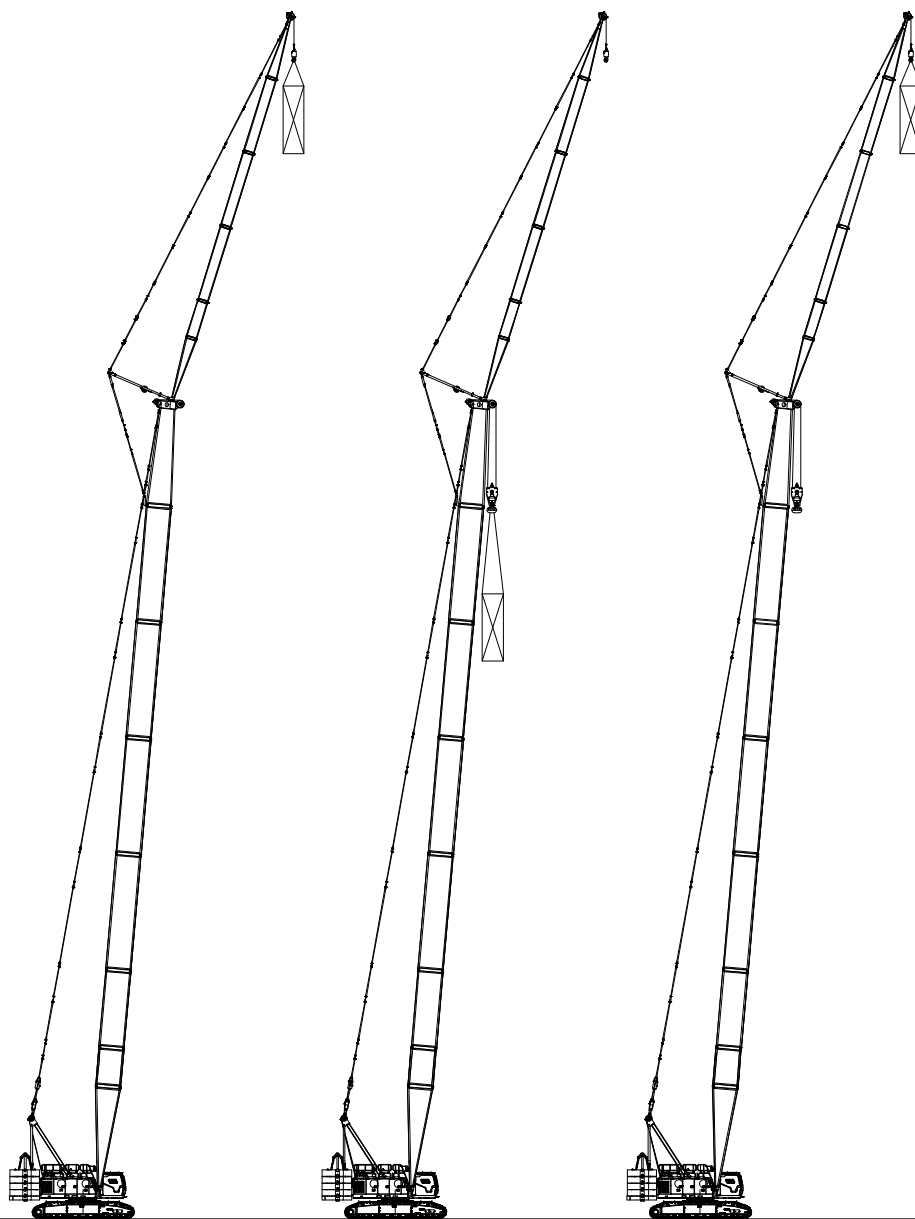

FJ Configuration  
(single hook)

FJm Configuration  
(double hooks, load  
on main hook)

FJa Configuration  
(double hooks, load  
on aux. hook)

Configuration	Boom Combination	Boom Length
FJ	Boom + Fixed Jib (single hook)	( 22m~61m)+(13m~31m)
FJm	Boom + Fixed Jib (double hooks, load on main hook)	
FJa	Boom + Fixed Jib (double hooks, load on aux. hook)	

Note: The schematics above are reference for loading only.

**Boom Combination**

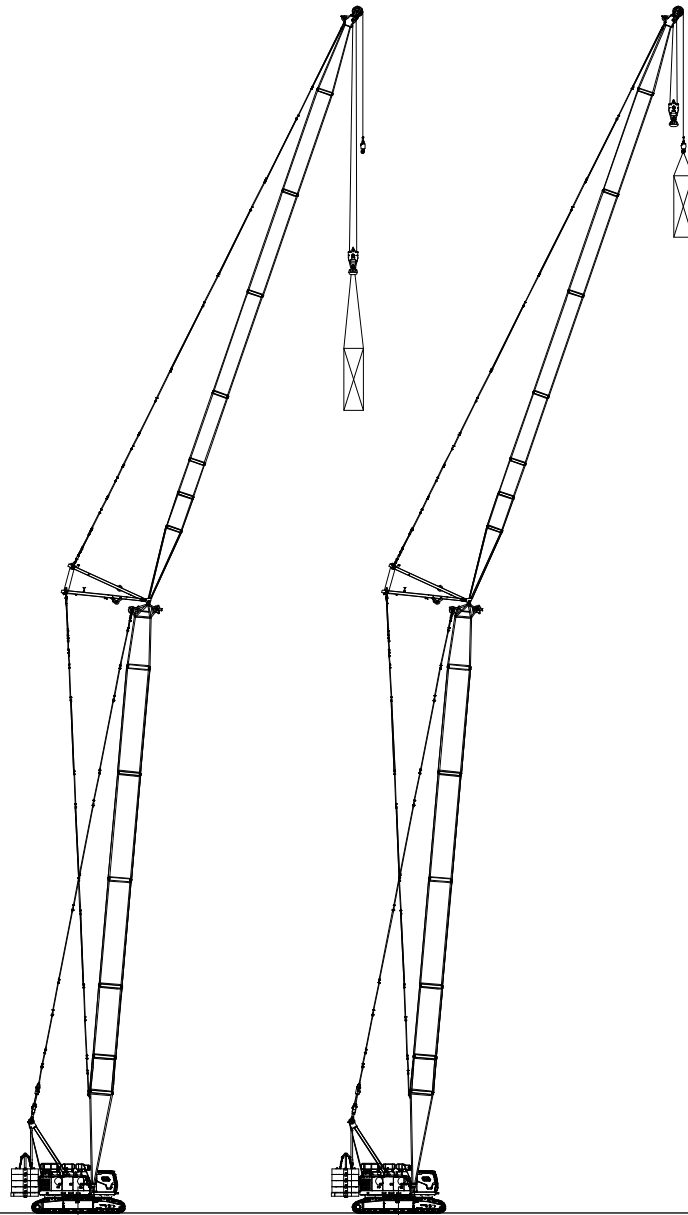

LJ Configuration  
(double hooks, load on  
luffing jib hook)

LJa Configuration  
(double hooks, load on  
extension jib hook)

Configuration	Boom Combination	Boom Length
LJ	Boom + Luffing Jib (double hooks, load on luffing jib hook)	49m+52m
LJa	Boom + Luffing Jib (double hooks, load on extension jib hook)	

Note: The schematics above are reference for loading only.

## H Configuration

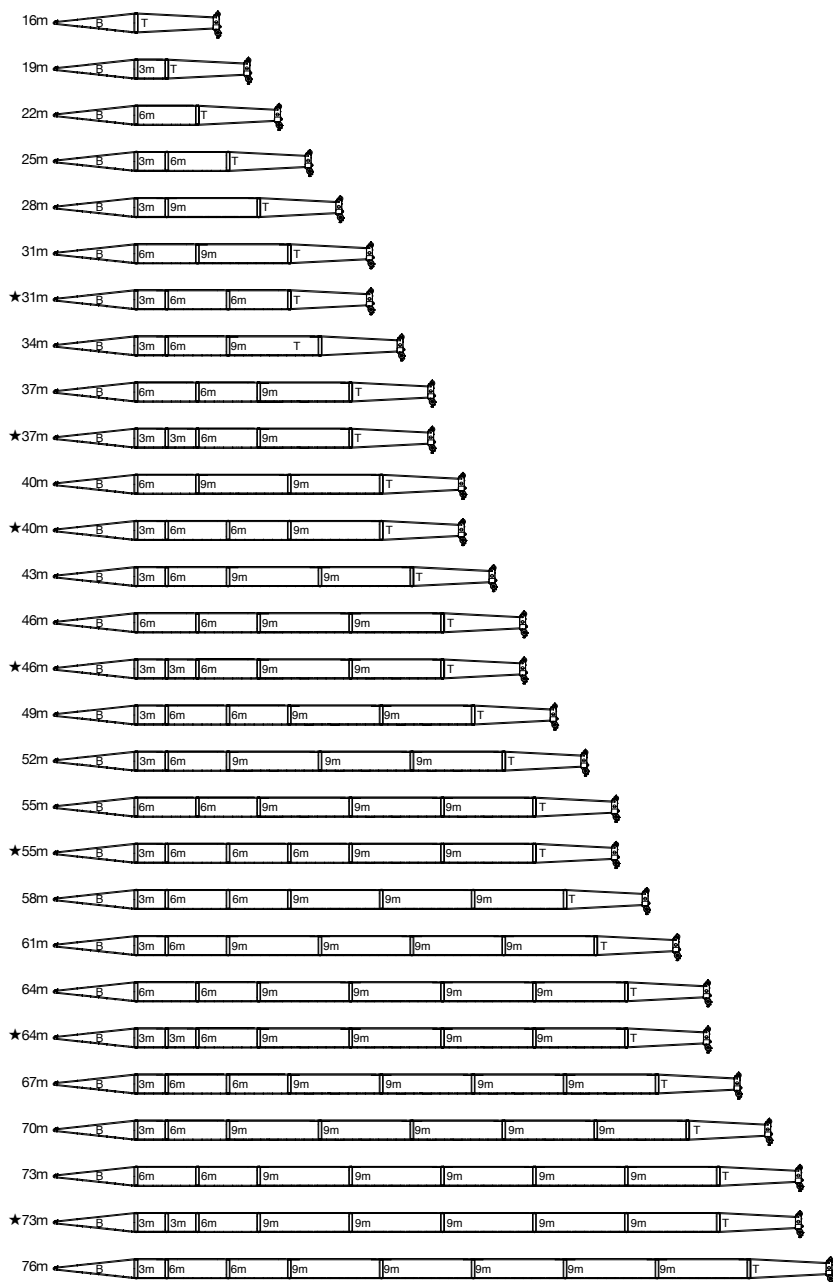

Note: The boom combinations with "★" are recommended for purchasing.

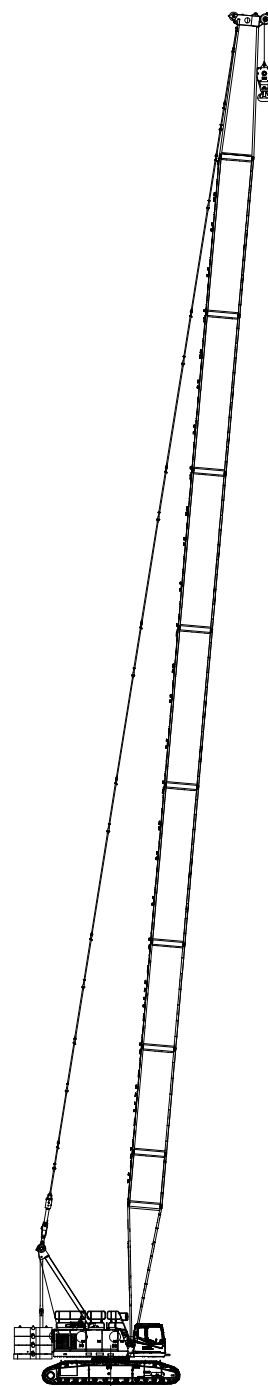
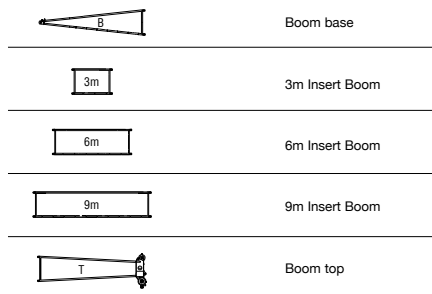

H Configuration  
(16m~76m)

# H Working Radius

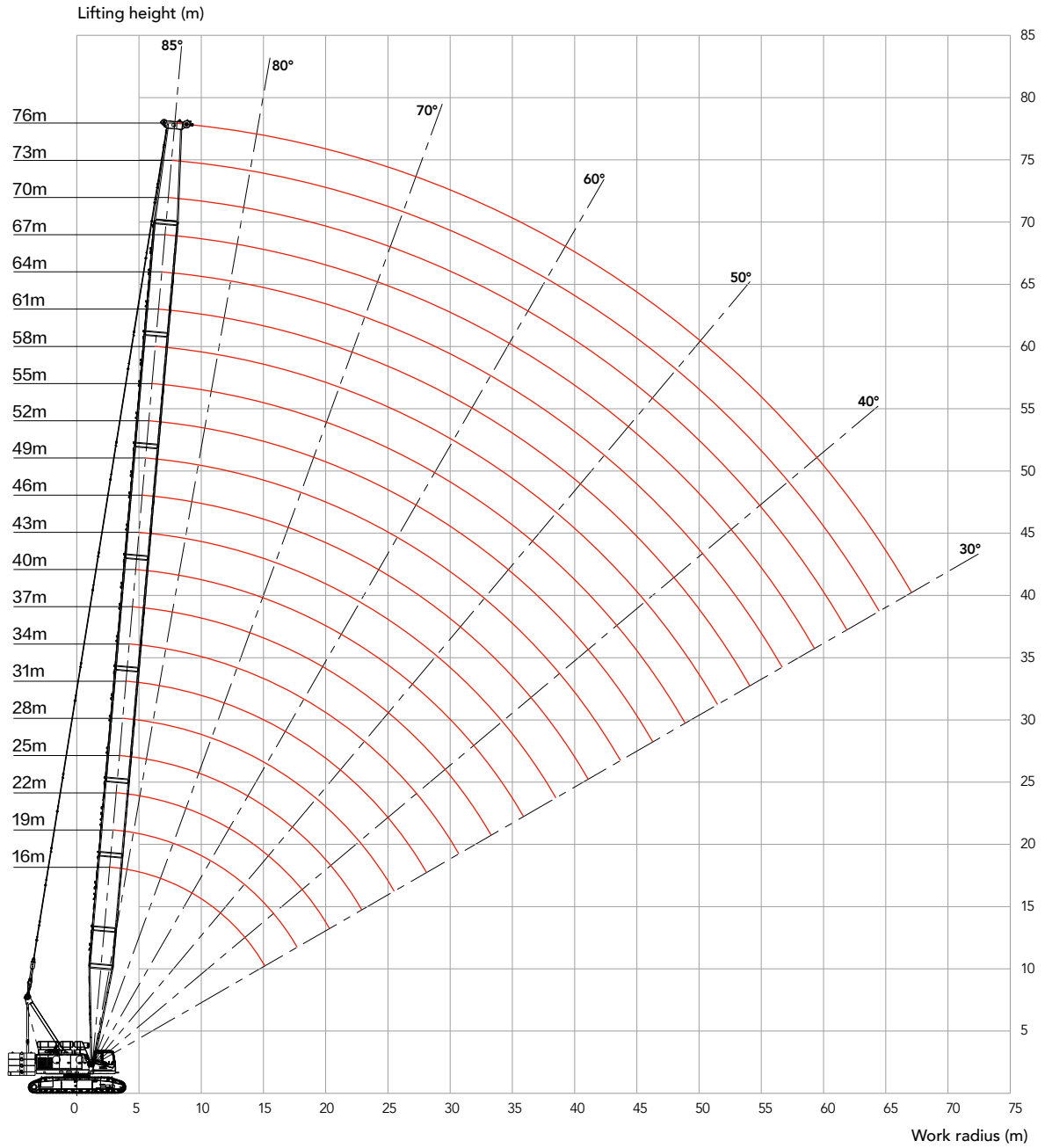



Unit: t

## H Load Chart

Note:

- 1.The rated load in the load chart is calculated complying with EN 13000;
- 2.The working radius is the horizontal distance from the load center to the swing center;
- 3.The actual lifting capacity must subtract the weight of hooks and other riggings from the rated capacity in the load chart.
- 4.The load value is calculated when the object is hung freely,without considering the influence of wind on the load, ground conditions and slope, operation speed and the influence of anyother negative factors over safe operation. Therefore, the operator bears the responsibility of making a judgement and decreasing the load and lowering speed.
- 5.All ratings are calculated when the machine is parking on firm and level ground with less than 1% gradient.
- 6.Parts of line as below are based on rated single line pull of 13.5t.
7. See the Operation Manual for the complete load charts of HCm andHCa configurations.

### Load chart -H( Load on main hook, Boom 16~76m, Without extension jib) 1/6

Boom length(m)	16					19					22					Boom length(m)
Counter weight (t)	55.3+20	41.1+0 / 44.8+0	26.9+0 / 34.3+0	12.7+0 / 13.3+0	0+0	55.3+20	41.1+0 / 44.8+0	26.9+0 / 34.3+0	12.7+0 / 13.3+0	0+0	55.3+20	41.1+0 / 44.8+0	26.9+0 / 34.3+0	12.7+0 / 13.3+0	0+0	Counter weight (t)
Radius(m)																Radius(m)
4.6	135.0															4.6
5	132.0					131.0					120.0					5
6	120.0	105.0	85.0	60.0	40.0	119.0					118.0					6
7	101.4	86.6	69.5	51.3	34.9	100.7	86.0	69.0	50.9	34.7	100.1	83.8	67.7	50.1	33.9	7
8	87.8	69.7	55.9	41.1	27.8	87.2	69.2	55.5	40.8	27.6	86.7	68.8	55.1	40.6	27.5	8
9	77.3	58.2	46.6	34.2	23.0	76.8	57.8	46.3	33.9	22.8	76.4	57.5	46.0	33.7	22.7	9
10	67.7	49.9	39.8	29.2	19.5	67.3	49.6	39.6	28.9	19.4	66.9	49.3	39.4	28.8	19.2	10
12	52.0	38.6	30.8	22.4	14.8	51.6	38.4	30.5	22.2	14.7	51.3	38.2	30.3	22.0	14.5	12
14	42.5	31.4	24.9	18.0	11.8	42.2	31.1	24.7	17.8	11.6	42.0	31.0	24.5	17.7	11.5	14
16						35.5	26.1	20.6	14.7	9.5	35.3	25.9	20.4	14.6	9.4	16
18						30.5	22.3	17.6	12.5	7.9	30.3	22.2	17.4	12.3	7.8	18
20											26.5	19.3	15.1	10.6	6.6	20
Parts of line	12	8	7	6	4	11	7	6	4	3	10	7	6	4	3	Parts of line

### Load chart -H( Load on main hook, Boom 16~76m, Without extension jib) 2/6

Boom length(m)	25					28					31					Boom length(m)
Counter weight (t)	55.3+20	41.1+0 / 44.8+0	26.9+0 / 34.3+0	12.7+0 / 13.3+0	0+0	55.3+20	41.1+0 / 44.8+0	26.9+0 / 34.3+0	12.7+0 / 13.3+0	0+0	55.3+20	41.1+0 / 44.8+0	26.9+0 / 34.3+0	12.7+0 / 13.3+0	0+0	Counter weight (t)
Radius(m)																Radius(m)
6	111.0					102.2					94.5					6
7	99.4	80.8	65.2	48.2	32.6	98.8					93.9					7
8	86.1	68.4	54.8	40.3	27.2	85.6	66.3	53.4	39.3	26.3	83.9	64.3	51.7	38.0	25.4	8
9	75.9	57.2	45.7	33.5	22.5	75.4	56.8	45.4	33.2	22.3	74.5	56.0	44.9	32.9	21.8	9
10	66.5	49.0	39.1	28.5	19.1	66.1	48.7	38.8	28.3	18.9	65.8	48.4	38.6	28.1	18.7	10
12	50.9	37.9	30.1	21.8	14.4	50.6	37.7	29.9	21.7	14.2	50.2	37.5	29.7	21.5	14.1	12
14	41.7	30.7	24.3	17.5	11.3	41.5	30.5	24.1	17.3	11.2	41.3	30.3	24.0	17.2	11.1	14
16	35.0	25.7	20.2	14.4	9.2	34.8	25.5	20.1	14.3	9.1	34.6	25.3	19.9	14.1	8.9	16
18	30.1	22.0	17.2	12.2	7.6	29.9	21.8	17.1	12.0	7.5	29.7	21.6	16.9	11.9	7.4	18
20	26.3	19.1	14.9	10.4	6.4	26.1	19.0	14.8	10.3	6.3	25.9	18.8	14.6	10.1	6.1	20
22	23.3	16.8	13.1	9.0	5.4	23.1	16.7	12.9	8.9	5.3	22.9	16.5	12.8	8.8	5.2	22
24						20.7	14.8	11.4	7.8	4.5	20.5	14.7	11.3	7.6	4.4	24
26							13.3	10.2			18.5	13.1	10.0	6.7	3.7	26
28											16.7	11.9	9.0		3.2	28
Parts of line	9	6	5	4	3	8	5	4	3	2	8	5	4	3	2	Parts of line

## H Load Chart

Load chart -H( Load on main hook, Boom 16~76m, Without extension jib) 3/6

Boom length(m)	34					37					40					Boom length(m)
Counter weight (t)	55.3+20	41.1+0 / 44.8+0	26.9+0 / 34.3+0	12.7+0 / 13.3+0	0+0	55.3+20	41.1+0 / 44.8+0	26.9+0 / 34.3+0	12.7+0 / 13.3+0	0+0	55.3+20	41.1+0 / 44.8+0	26.9+0 / 34.3+0	12.7+0 / 13.3+0	0+0	Counter weight (t)
Radius(m)																Radius(m)
6	88.5															6
7	84.0					75.6					73.3					7
8	81.3	62.4	50.1	36.8	24.5	72.6					71.2					8
9	72.2	54.4	43.6	31.9	21.0	70.2	53.0	42.4	30.9	20.3	68.4	51.6	41.3	30.0	19.6	9
10	65.1	48.1	38.3	27.9	18.3	63.3	47.0	37.5	27.2	17.7	61.6	45.8	36.5	26.4	17.1	10
12	50.9	37.2	29.5	21.3	13.9	50.6	37.0	29.3	21.1	13.8	50.3	36.7	29.1	20.9	13.4	12
14	41.0	30.1	23.7	17.0	10.9	40.6	29.9	23.6	16.8	10.7	39.4	29.7	23.4	16.6	10.6	14
16	34.4	25.1	19.7	13.9	8.8	34.4	24.9	19.5	13.8	8.6	34.0	24.7	19.4	13.6	8.5	16
18	29.5	21.4	16.7	11.7	7.2	29.5	21.3	16.5	11.5	7.0	29.1	21.1	16.4	11.4	6.9	18
20	25.7	18.6	14.4	10.0	6.0	25.7	18.4	14.2	9.8	5.8	25.3	18.2	14.1	9.6	5.7	20
22	22.7	16.3	12.6	8.6	5.0	22.7	16.1	12.4	8.4	4.8	22.4	16.0	12.2	8.3	4.7	22
24	20.3	14.5	11.1	7.4	4.2	20.3	14.3	10.9	7.3	4.0	19.9	14.1	10.8	7.1	3.9	24
26	18.2	12.9	9.8	6.5	3.5	18.2	12.8	9.7	6.4	3.4	17.9	12.6	9.5	6.2	3.2	26
28	16.5	11.7	8.8	5.7	3.0	16.5	11.5	8.6	5.6	2.8	16.2	11.3	8.5	5.4	2.6	28
30	15.1	10.5	7.9	5.0	2.5	15.1	10.4	7.7	4.9	2.4	14.7	10.2	7.6	4.7	2.1	30
32						13.8	9.4	7.0	4.3		13.5	9.3	6.8	4.2		32
34											12.4	8.4	6.1	3.7		34
36											11.4	7.7	5.5	3.2		36
Parts of line	7	5	4	3	2	6	4	4	3	2	6	4	4	3	2	Parts of line

Unit: t

## H Load Chart

Load chart -H( Load on main hook, Boom 16~76m, Without extension jib) 4/6

Boom length(m)	43				46				49				Boom length(m)
Counter weight (t)	55.3+20	41.1+0 / 44.8+0	26.9+0 / 34.3+0	12.7+0 / 13.3+0	55.3+20	41.1+0 / 44.8+0	26.9+0 / 34.3+0	12.7+0 / 13.3+0	55.3+20	41.1+0 / 44.8+0	26.9+0 / 34.3+0	12.7+0 / 13.3+0	Counter weight (t)
Radius(m)													Radius(m)
8	66.2				62.6				57.4				8
9	61.6	50.2	40.1	29.1	58.8				55.3				9
10	60.0	44.6	35.5	25.6	54.9	43.5	34.6	24.9	52.8	42.4	33.7	24.2	10
12	50.0	36.3	28.7	20.5	49.0	35.5	28.0	19.9	47.8	34.6	27.3	19.3	12
14	40.7	29.5	23.2	16.4	40.5	29.3	23.0	16.3	40.3	29.0	22.7	15.8	14
16	33.2	24.5	19.2	13.4	32.5	24.3	19.0	13.3	33.7	24.1	18.8	13.1	16
18	28.9	20.9	16.2	11.2	28.5	20.7	16.0	11.0	27.8	20.5	15.8	10.8	18
20	25.1	18.0	13.9	9.5	24.9	17.9	13.7	9.3	24.7	17.6	13.5	9.1	20
22	22.1	15.8	12.0	8.1	22.0	15.6	11.9	7.9	21.7	15.4	11.7	7.7	22
24	19.7	13.9	10.6	7.0	19.5	13.8	10.4	6.8	19.3	13.6	10.2	6.6	24
26	17.7	12.4	9.3	6.0	17.5	12.2	9.2	5.9	17.3	12.0	9.0	5.7	26
28	16.0	11.1	8.3	5.2	15.8	11.0	8.1	5.1	15.6	10.8	7.9	4.8	28
30	14.5	10.0	7.4	4.6	14.4	9.9	7.2	4.4	14.1	9.7	7.0	4.2	30
32	13.3	9.1	6.6	4.0	13.1	8.9	6.4	3.8	12.9	8.7	6.2	3.5	32
34	12.2	8.2	5.9	3.5	12.0	8.1	5.8	3.3	11.8	7.9	5.6	3.0	34
36	11.2	7.5	5.3	3.0	11.0	7.3	5.2	2.8	10.8	7.1	5.0	2.6	36
38	10.3	6.8	4.8	2.6	10.2	6.7	4.6	2.4	10.0	6.5	4.4	2.1	38
40					9.4	6.1	4.2	2.1	9.2	5.9	4.0		40
42									8.5	5.4	3.5		42
44									7.9	4.9	3.1		44
Parts of line	5	4	3	3	5	4	3	2	5	4	3	2	Parts of line

**H Load Chart****Load chart -H( Load on main hook, Boom 16~76m, Without extension jib) 5/6**

Boom length(m)	52			55			58			Boom length(m)
Counter weight (t) Radius(m)	55.3+20	41.1+0 / 44.8+0	26.9+0 / 34.3+0	55.3+20	41.1+0 / 44.8+0	26.9+0 / 34.3+0	55.3+20	41.1+0 / 44.8+0	26.9+0 / 34.3+0	Counter weight (t) Radius(m)
9	51.8			48.4			43.6			9
10	49.9	41.4	32.8	47.3			42.5			10
12	46.7	33.8	26.6	41.4	33.1	26.0	39.7	32.3	25.3	12
14	39.7	28.4	22.1	39.0	27.7	21.6	38.2	27.1	21.0	14
16	33.5	23.9	18.6	33.3	23.7	18.3	32.9	23.1	17.8	16
18	27.2	20.3	15.6	28.5	20.1	15.4	28.3	19.9	15.2	18
20	24.1	17.5	13.3	23.6	17.3	13.2	24.6	17.1	13.0	20
22	21.6	15.2	11.5	21.1	15.0	11.3	20.5	14.8	11.1	22
24	19.1	13.4	10.0	18.9	13.2	9.9	18.5	13.0	9.7	24
26	17.1	11.9	8.8	16.9	11.7	8.6	16.7	11.5	8.4	26
28	15.4	10.6	7.7	15.2	10.4	7.6	15.0	10.2	7.4	28
30	14.0	9.5	6.9	13.8	9.3	6.7	13.6	9.1	6.4	30
32	12.7	8.5	6.1	12.5	8.4	5.9	12.3	8.2	5.6	32
34	11.6	7.7	5.4	11.4	7.5	5.2	11.2	7.3	5.0	34
36	10.7	7.0	4.8	10.5	6.8	4.6	10.3	6.6	4.3	36
38	9.8	6.3	4.3	9.6	6.1	4.1	9.4	5.9	3.8	38
40	9.0	5.7	3.8	8.8	5.6	3.6	8.6	5.4	3.3	40
42	8.3	5.2	3.4	8.2	5.0	3.2	8.0	4.8	2.9	42
44	7.7	4.7	3.0	7.5	4.6	2.8	7.3	4.4	2.5	44
46	7.1	4.3	2.6	7.0	4.1	2.5	6.8	3.9	2.1	46
48				6.4	3.7	2.1	6.2	3.5		48
50							5.8	3.2		50
Parts of line	4	4	3	4	3	2	4	3	2	Parts of line

Unit: t

## H Load Chart

Load chart -H( Load on main hook, Boom 16~76m, Without extension jib) 6/6

Boom length(m)	61		64		67		70	73	76	Boom length(m)
Counter weight (t)	55.3+20	41.1+0 / 44.8+0	55.3+20	41.1+0 / 44.8+0	55.3+20	41.1+0 / 44.8+0	55.3+20	55.3+20	55.3+20	Counter weight (t)
Radius(m)										Radius(m)
10	38.8		34.2		30.9					10
12	36.4	31.5	33.6		30.1		27.5	24.7	22.1	12
14	33.7	26.5	32.2	25.8	28.6	25.2	26.6	23.5	21.0	14
16	32.3	22.6	30.7	22.1	27.5	21.5	25.3	22.5	19.9	16
18	28.1	19.5	27.7	19.0	27.2	18.6	23.5	21.5	19.0	18
20	24.4	16.9	24.2	16.6	24.0	16.1	22.2	20.3	18.1	20
22	21.4	14.7	21.2	14.5	21.0	14.2	20.8	19.1	17.2	22
24	18.0	12.8	18.8	12.7	18.6	12.3	18.4	18.2	16.1	24
26	16.3	11.3	15.8	11.1	16.6	10.8	16.4	16.2	15.2	26
28	14.8	10.0	14.3	9.9	13.9	9.5	14.7	14.6	14.4	28
30	13.4	8.9	13.0	8.8	12.6	8.4	12.2	13.1	12.9	30
32	12.2	8.0	11.9	7.8	11.5	7.5	11.1	10.8	11.7	32
34	11.1	7.2	10.9	7.0	10.5	6.6	10.1	9.8	10.6	34
36	10.1	6.4	9.9	6.2	9.6	5.9	9.2	8.9	9.6	36
38	9.2	5.8	9.1	5.6	8.7	5.2	8.4	8.1	7.7	38
40	8.5	5.2	8.3	5.0	8.0	4.6	7.7	7.4	7.0	40
42	7.8	4.7	7.6	4.4	7.3	4.1	7.0	6.7	6.3	42
44	7.2	4.2	7.0	3.9	6.7	3.6	6.4	6.1	5.7	44
46	6.6	3.8	6.4	3.5	6.1	3.2	5.8	5.5	5.2	46
48	6.1	3.4	5.9	3.1	5.6	2.8	5.3	5.0	4.7	48
50	5.6	3.0	5.4	2.7	5.1	2.4	4.8	4.5	4.2	50
52	5.2		5.0		4.7		4.4	4.1	3.8	52
54	4.7		4.6		4.3		4.0	3.7	3.4	54
56			4.2		3.9		3.6	3.3	3.0	56
58					3.6		3.3	3.0	2.7	58
60							2.9	2.6		60
62							2.6			62
Parts of line	3	3	3	2	3	2	3	2	2	Parts of line

## Hh Configuration

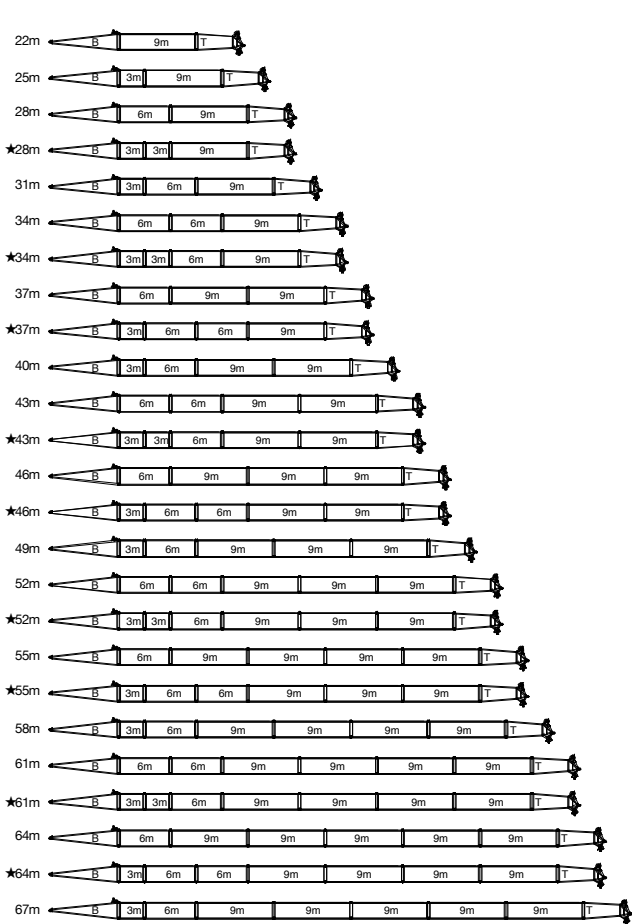

Note: The boom combinations with "★" are recommended for purchasing.

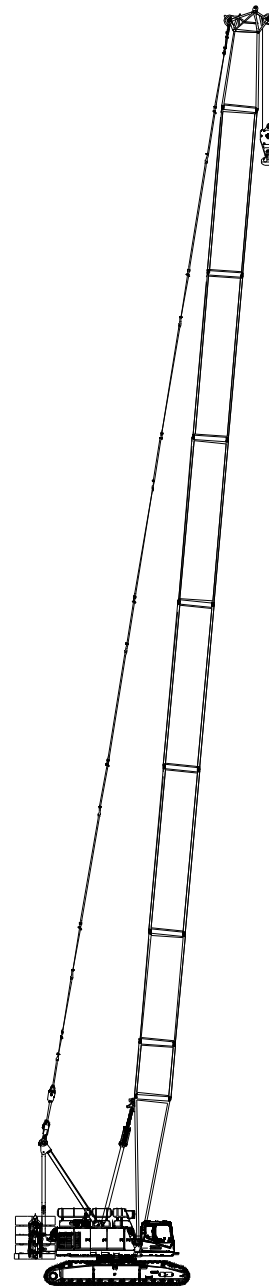
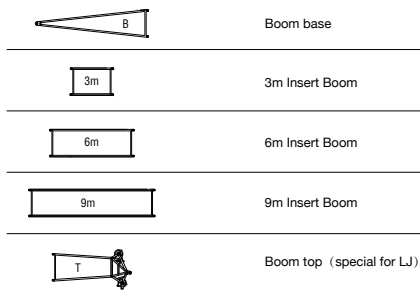

Hh Configuration  
(22m~67m)

## Hh Working Radius

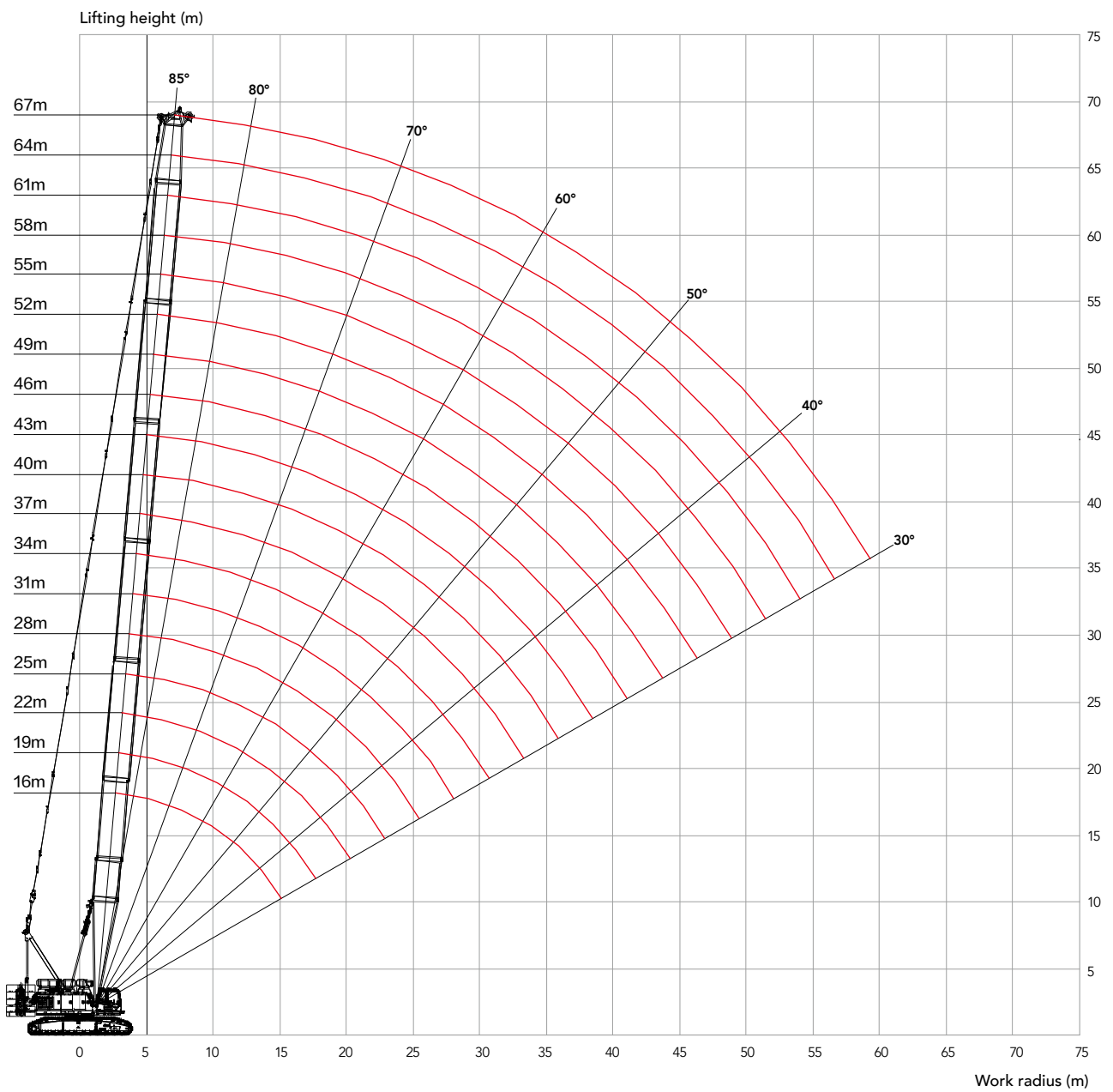

# Hh Load Chart

Load chart -Hh																	
Load on main hook, Boom 22~67m																	
Boom length (m) Radius (m)	22	25	28	31	34	37	40	43	46	49	52	55	58	61	64	67	Boom length (m) Radius (m)
7	72.0	71.8	71.6														7
8	71.3	70.9	70.5	70.2	69.9	69.6	63.4	61.7									8
9	70.2	69.6	69.2	67.0	64.9	63.2	61.3	54.7	53.3	52.1	48.3	47.6	42.5				9
10	62.8	62.2	61.7	60.2	58.4	56.9	55.2	50.7	49.8	46.7	45.6	44.7	40.1	38.2	34.2	30.9	10
12	51.3	50.9	50.6	50.2	48.7	47.5	46.0	44.7	43.6	41.5	41.5	40.6	36.1	35.3	32.8	30.1	12
14	42.0	41.7	41.5	41.3	41.0	40.6	39.4	38.4	37.4	36.4	35.5	34.3	33.1	31.5	30.6	28.6	14
16	35.3	35.0	34.8	34.6	34.4	34.4	34.0	33.2	32.5	31.7	31.0	29.6	28.4	27.2	26.3	25.2	16
18	30.3	30.1	29.9	29.7	29.5	29.5	29.1	28.9	28.5	27.8	27.2	25.7	24.9	23.9	22.9	22.1	18
20	26.5	26.3	26.1	25.9	25.7	25.7	25.3	25.1	24.9	24.7	24.1	22.9	21.9	21.0	20.2	19.5	20
22		23.3	23.1	22.9	22.7	22.7	22.4	22.1	22.0	21.7	21.6	20.4	19.6	18.7	18.1	17.3	22
24			20.7	20.5	20.3	20.3	19.9	19.7	19.5	19.3	19.1	18.2	17.5	16.8	16.2	15.4	24
26				18.5	18.2	18.2	17.9	17.7	17.5	17.3	17.1	16.5	15.8	15.2	14.5	13.9	26
28				16.7	16.5	16.5	16.2	16.0	15.8	15.6	15.4	14.9	14.3	13.7	13.0	12.5	28
30					15.0	15.1	14.7	14.5	14.4	14.1	14.0	13.6	13.0	12.4	11.9	11.3	30
32						13.6	13.5	13.3	13.1	12.9	12.7	12.3	11.8	11.2	10.8	10.3	32
34							12.2	12.2	12.0	11.8	11.6	11.1	10.7	10.3	9.8	9.3	34
36							10.6	10.9	11.0	10.8	10.5	10.2	9.7	9.4	8.9	8.4	36
38								9.6	9.7	9.8	9.4	9.1	8.9	8.5	8.0	7.6	38
40									8.6	8.7	8.5	8.3	8.0	7.6	7.2	6.9	40
42										7.8	7.5	7.5	7.3	7.0	6.5	6.3	42
44										6.7	6.7	6.7	6.5	6.2	6.0	5.6	44
46											5.9	5.9	5.8	5.5	5.3	5.0	46
48												5.1	5.0	5.0	4.7	4.4	48
50													4.4	4.3	4.2	3.8	50
52														3.6	3.5	3.4	52
54															3.1	3.0	54
56																2.5	56
Counter weight (t)	55.3+20																Counter weight (t)
Parts of line	6	6	6	6	6	6	6	5	5	5	4	4	4	3	3	3	Parts of line



## FJ Configuration

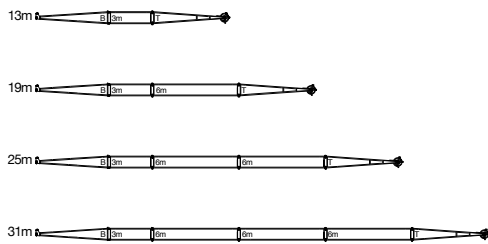

	5m	5m Jib base
	5m	5m Jib top
	6m	6m Jib insert
	3m	3m Jib insert

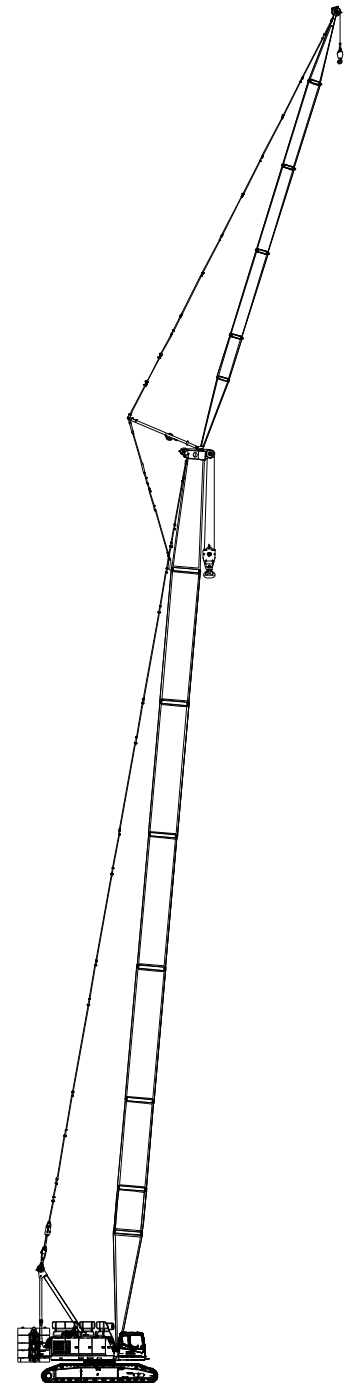

FJ Configuration  
(22m~61m)+(13m~31m)

## FJ Working Radius

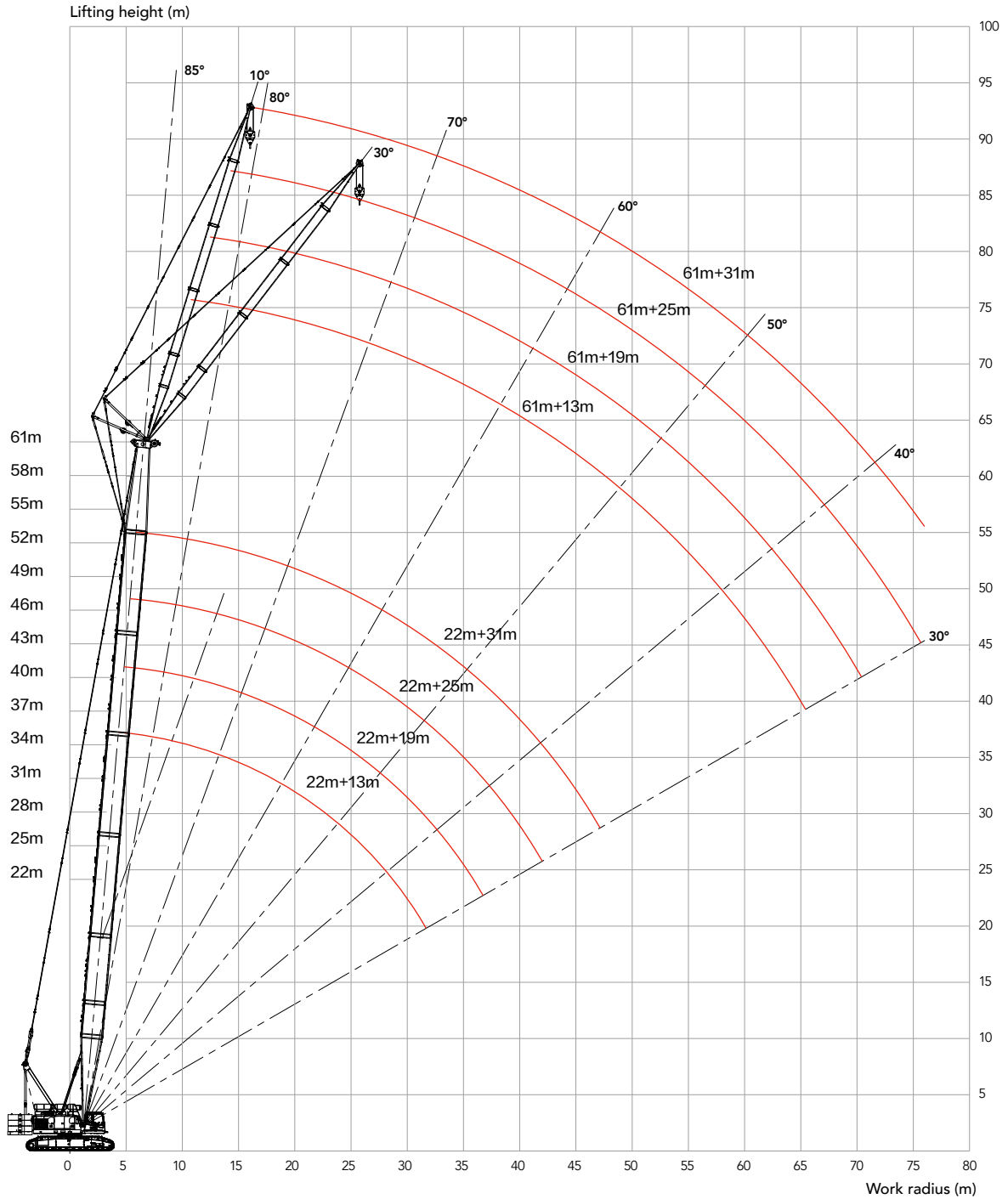

## FJ Load Chart

**Note:**

- 1.The rated load in the load chart is calculated complying with EN 13000.
- 2.The working radius is the horizontal distance from the load center to the swing center.
- 3.The actual lifting capacity must subtract the weight of hooks and other riggings from the rated capacity in the load chart.
- 4.The load value is calculated when the object is hung freely,without considering the influence of wind on the load, ground conditions and slope, operation speed and the influence of anyother negative factors over safe operation. Therefore, the operator bears the responsibility of making a judgement and decreasing the load and lowering speed.
- 5.All ratings are calculated when the machine is parking on firm and level ground with less than 1% gradient.
6. When the jib length is 42.7ft (13m), 1 part of line shall not be permitted.
- 7.Parts of line as below are based on rated single line pull of 13.5t.
8. See the Operation Manual for the complete load charts of FJ, FJm and FJa configurations.

### Load chart –FJ( Load on aux. hook, Boom 21~61m, Without main hook) 1/4

Jib 13m, Boom to jib angle 10°															
Boom length (m) Radius (m)	22	25	28	31	34	37	40	43	46	49	52	55	58	61	Boom length (m) Radius (m)
9	27.0	27.0													9
10	27.0	27.0	27.0	26.8	26.8										10
12	26.9	26.5	26.8	26.8	26.8	26.5	25.8	25.1							12
14	26.2	25.8	26.1	26.3	26.5	26.5	25.8	25.1	24.4	23.6	22.9	22.0			14
16	25.6	24.9	25.3	25.5	25.8	26.0	25.7	25.2	24.4	23.6	22.9	22.0	21.3	20.5	16
18	25.1	24.4	24.6	24.5	24.9	25.1	25.2	24.5	24.1	23.3	22.3	21.3	21.0	20.2	18
20	24.3	23.5	23.3	23.3	23.5	23.7	23.1	22.4	21.8	21.2	20.7	20.1	19.6	19.1	20
22	22.9	22.3	22.1	21.9	21.9	21.7	21.0	20.3	19.8	19.2	18.7	18.2	17.7	17.2	22
24	20.7	20.5	20.3	20.1	19.9	19.8	19.2	18.6	18.1	17.5	17.0	16.6	16.1	15.6	24
26	18.7	18.5	18.3	18.1	17.9	17.9	17.6	17.1	16.6	16.1	15.6	15.2	14.7	14.3	26
28	17.0	16.8	16.6	16.5	16.3	16.2	15.9	15.7	15.3	14.8	14.4	13.9	13.5	13.1	28
30	15.6	15.4	15.2	15.0	14.8	14.8	14.5	14.3	14.1	13.9	13.3	12.9	12.5	12.1	30
32	14.4	14.1	14.0	13.8	13.6	13.5	13.2	13.1	12.9	12.7	12.5	11.9	11.5	11.1	32
34		13.1	12.9	12.7	12.5	12.5	12.2	12.0	11.8	11.6	11.4	11.3	11.0	10.3	34
36			11.9	11.8	11.6	11.5	11.2	11.0	10.8	10.7	10.5	10.3	10.1	9.7	36
38			11.1	10.9	10.7	10.7	10.4	10.2	10.0	9.8	9.6	9.5	9.3	8.9	38
40				10.2	10.0	9.9	9.6	9.4	9.2	9.1	8.9	8.7	8.5	8.2	40
42					9.3	9.2	8.9	8.7	8.6	8.4	8.2	8.0	7.8	7.6	42
44						8.6	8.3	8.1	7.9	7.8	7.6	7.4	7.2	7.0	44
46							7.8	7.6	7.4	7.2	7.0	6.9	6.6	6.4	46
48							7.2	7.0	6.9	6.7	6.5	6.3	6.1	5.9	48
50								6.6	6.4	6.2	6.0	5.8	5.6	5.4	50
52									6.0	5.7	5.5	5.3	5.1	4.9	52
54										5.3	5.1	4.9	4.7	4.5	54
56										4.9	4.7	4.5	4.3	4.1	56
58											4.4	4.2	3.9	3.7	58
60												3.8	3.6	3.4	60
62													3.4	3.2	62
64													3.0	2.8	64
66														2.5	66
Counter weight ( t )	55.3+20														Counter weight ( t )
Parts of line	2	2	2	2	2	2	2	2	2	2	2	2	2	2	Parts of line

## FJ Load Chart

Load chart -FJ( Load on aux. hook, Boom 21~61m, Without main hook) 2/4

Jib 31m, Boom to jib angle 10°															
Boom length (m) Radius (m)	22	25	28	31	34	37	40	43	46	49	52	55	58	61	Boom length (m) Radius (m)
16	7.3	7.3													16
18	7.1	7.1	7.1	7.1	7.0										18
20	6.8	6.8	6.9	6.9	6.8	6.8	6.8	6.8							20
22	6.5	6.5	6.5	6.6	6.6	6.6	6.6	6.5	6.5	6.5	6.4	6.4			22
24	6.3	6.3	6.4	6.4	6.4	6.4	6.4	6.4	6.4	6.3	6.3	6.2	6.2	6.0	24
26	6.1	6.1	6.2	6.2	6.2	6.2	6.2	6.2	6.2	6.2	6.2	6.1	6.0	5.9	26
28	5.9	5.9	5.9	6.0	6.0	6.0	6.0	6.0	6.0	6.0	6.0	5.9	5.9	5.8	28
30	5.7	5.7	5.8	5.8	5.8	5.9	5.9	5.9	5.9	5.9	5.9	5.8	5.7	5.7	30
32	5.5	5.5	5.5	5.6	5.6	5.7	5.7	5.7	5.7	5.7	5.7	5.6	5.6	5.5	32
34	5.3	5.3	5.4	5.5	5.5	5.5	5.5	5.5	5.5	5.5	5.5	5.5	5.5	5.5	34
36	5.1	5.2	5.2	5.3	5.3	5.3	5.4	5.4	5.4	5.4	5.4	5.4	5.4	5.3	36
38	4.9	5.0	5.1	5.2	5.2	5.2	5.2	5.2	5.2	5.2	5.2	5.2	5.2	5.2	38
40	4.7	4.9	4.9	5.0	5.0	5.1	5.1	5.1	5.1	5.1	5.1	5.2	5.1	5.1	40
42	4.5	4.6	4.8	4.9	4.9	4.9	4.9	5.0	5.0	5.0	4.9	5.0	5.0	5.0	42
44	4.3	4.5	4.6	4.7	4.8	4.8	4.9	4.9	4.9	4.9	4.8	4.9	4.9	4.9	44
46	4.2	4.4	4.5	4.6	4.6	4.7	4.7	4.8	4.8	4.8	4.8	4.8	4.8	4.8	46
48	4.0	4.2	4.4	4.5	4.5	4.5	4.6	4.6	4.7	4.7	4.7	4.7	4.7	4.7	48
50		4.0	4.2	4.4	4.4	4.5	4.5	4.5	4.5	4.5	4.6	4.6	4.6	4.6	50
52		3.9	4.1	4.2	4.3	4.4	4.4	4.4	4.5	4.5	4.5	4.5	4.5	4.5	52
54			3.9	4.1	4.2	4.3	4.3	4.3	4.4	4.4	4.3	4.3	4.3	4.3	54
56				3.9	4.1	4.2	4.2	4.2	4.3	4.3	4.2	4.2	4.2	4.2	56
58					4.0	4.1	4.2	4.1	4.2	4.2	4.1	4.1	4.1	4.0	58
60					3.9	3.9	4.1	3.9	4.0	4.1	4.0	4.0	4.0	3.8	60
62							3.9	3.8	3.8	3.9	3.9	3.9	3.8	3.5	62
64							3.6	3.6	3.6	3.7	3.7	3.7	3.5	3.2	64
66									3.3	3.5	3.5	3.4	3.2	3.0	66
68									3.1	3.3	3.3	3.1	2.9	2.7	68
70									2.9	3.1	3.1	2.9	2.6	2.4	70
72										2.9	2.8	2.6	2.4	2.2	72
74												2.4	2.2		74
76												2.2	2.1		76
78												2.1			78
Counter weight(t) Parts of line	55.3+20														Counter weight(t) Parts of line
	1	1	1	1	1	1	1	1	1	1	1	1	1	1	

Unit: t

### FJ Load Chart

Load chart –FJ( Load on aux. hook, Boom 21~61m, Without main hook) 3/4															
Jib 13m, Boom to jib angle 30°															
Boom length (m) Radius (m)	22	25	28	31	34	37	40	43	46	49	52	55	58	61	Boom length (m) Radius (m)
12	23.5	23.1													12
14	22.7	22.3	22.1	21.9	21.8										14
16	21.8	21.5	21.4	21.3	21.2	21.1	21.0	20.9							16
18	20.5	20.2	20.1	20.1	20.0	19.9	19.8	19.7	19.6	19.5	19.4	19.3			18
20	19.6	19.3	19.2	19.1	18.9	18.8	18.7	18.6	18.5	18.4	18.3	18.2	18.1	17.6	20
22	18.7	18.4	18.1	17.9	17.8	17.6	17.5	17.4	17.3	17.2	17.1	17.0	16.9	16.6	22
24	17.9	17.6	17.3	17.1	16.9	16.8	16.7	16.6	16.5	16.4	16.2	16.1	15.9	15.7	24
26	17.2	16.8	16.5	16.3	16.1	16.0	15.8	15.7	15.6	15.5	15.3	15.2	14.8	14.4	26
28	16.5	16.1	15.8	15.6	15.5	15.4	15.2	15.1	15.0	14.9	14.5	14.0	13.6	13.2	28
30	15.7	15.3	15.0	14.9	14.8	14.6	14.4	14.3	14.2	13.8	13.4	13.0	12.6	12.2	30
32	14.5	14.0	14.2	14.0	13.9	13.8	13.6	13.4	13.3	12.8	12.5	12.1	11.7	11.3	32
34		13.1	13.0	12.9	12.7	12.7	12.5	12.3	12.2	12.0	11.6	11.2	10.9	10.5	34
36		12.2	12.1	11.9	11.8	11.7	11.5	11.3	11.2	11.0	10.9	10.7	10.1	9.8	36
38			11.2	11.0	10.9	10.9	10.6	10.4	10.3	10.1	10.0	9.8	9.7	9.1	38
40				10.2	10.1	10.1	9.8	9.7	9.5	9.3	9.2	9.1	8.9	8.7	40
42					9.4	9.4	9.1	8.9	8.8	8.6	8.5	8.3	8.2	8.0	42
44					8.7	8.7	8.5	8.3	8.2	8.0	7.8	7.7	7.5	7.4	44
46						8.1	7.9	7.7	7.6	7.4	7.3	7.1	6.9	6.8	46
48							7.3	7.2	7.0	6.9	6.7	6.6	6.4	6.2	48
50								6.7	6.5	6.4	6.2	6.0	5.9	5.7	50
52									6.1	5.9	5.7	5.6	5.4	5.2	52
54									5.6	5.4	5.3	5.1	4.9	4.7	54
56										5.0	4.8	4.7	4.5	4.3	56
58											4.4	4.3	4.1	3.9	58
60												3.9	3.7	3.6	60
62													3.6	3.4	62
64														3.0	64
66															66
Counter weight( t )	55.3+20														Counter weight( t )
Parts of line	2	2	2	2	2	2	2	2	2	2	2	2	2	2	Parts of line

## FJ Load Chart

Load chart -FJ( Load on aux. hook, Boom 21~61m, Without main hook) 4/4

Jib 31m, Boom to jib angle 30°															
Boom length (m) Radius (m)	22	25	28	31	34	37	40	43	46	49	52	55	58	61	Boom length (m) Radius (m)
24	5.5	5.5													24
26	5.2	5.3	5.3	5.3	5.2										26
28	5.0	5.1	5.1	5.1	5.1	5.3	5.2	5.2							28
30	4.9	4.9	4.9	5.0	4.9	5.1	5.0	5.0	5.0	5.0	5.1	5.1			30
32	4.6	4.7	4.7	4.8	4.8	5.0	4.9	4.9	4.9	4.9	5.0	5.0	5.0	5.0	32
34	4.5	4.6	4.6	4.7	4.6	4.8	4.7	4.7	4.8	4.8	4.8	4.9	4.9	4.9	34
36	4.3	4.4	4.4	4.5	4.5	4.7	4.6	4.6	4.6	4.7	4.7	4.8	4.8	4.8	36
38	4.3	4.3	4.3	4.4	4.3	4.5	4.5	4.5	4.5	4.5	4.5	4.6	4.7	4.7	38
40	4.1	4.2	4.2	4.3	4.2	4.3	4.4	4.4	4.4	4.5	4.5	4.5	4.5	4.6	40
42	4.0	4.1	4.1	4.1	4.1	4.2	4.3	4.3	4.3	4.3	4.4	4.5	4.5	4.5	42
44	4.0	4.0	4.0	4.0	4.0	4.1	4.2	4.2	4.2	4.2	4.3	4.3	4.4	4.4	44
46	3.9	4.0	3.9	4.0	4.0	4.0	4.1	4.1	4.1	4.2	4.2	4.2	4.3	4.3	46
48	3.8	3.9	3.8	3.9	3.9	3.9	4.0	4.0	4.0	4.1	4.2	4.2	4.2	4.2	48
50	3.8	3.8	3.8	3.8	3.9	3.9	3.9	3.9	4.0	4.0	4.1	4.1	4.1	4.1	50
52		3.7	3.7	3.8	3.8	3.8	3.8	3.9	3.9	4.0	4.0	4.0	4.0	4.0	52
54		3.6	3.6	3.7	3.8	3.7	3.7	3.9	3.8	3.9	3.9	4.0	3.9	3.9	54
56			3.5	3.6	3.7	3.7	3.7	3.8	3.7	3.8	3.8	3.9	3.8	3.8	56
58				3.5	3.6	3.6	3.6	3.7	3.7	3.7	3.7	3.7	3.7	3.7	58
60					3.5	3.5	3.5	3.6	3.7	3.6	3.6	3.6	3.6	3.6	60
62						3.4	3.4	3.4	3.6	3.5	3.5	3.5	3.5	3.4	62
64						3.3	3.3	3.3	3.5	3.4	3.4	3.4	3.4	3.2	64
66							3.2	3.2	3.4	3.3	3.3	3.3	3.3	3.1	66
68								3.1	3.3	3.2	3.2	3.1	3.2	3.0	68
70									3.2	3.1	3.1	2.9	3.0	2.8	70
72									3.1	3.0	2.9	2.7	2.8	2.6	72
74										2.9	2.7	2.5	2.5	2.4	74
76											2.5	2.3	2.2	2.1	76
Counter weight( t)	55.3+20														Counter weight( t)
Parts of line	1	1	1	1	1	1	1	1	1	1	1	1	1	1	Parts of line

## LJ Configuration

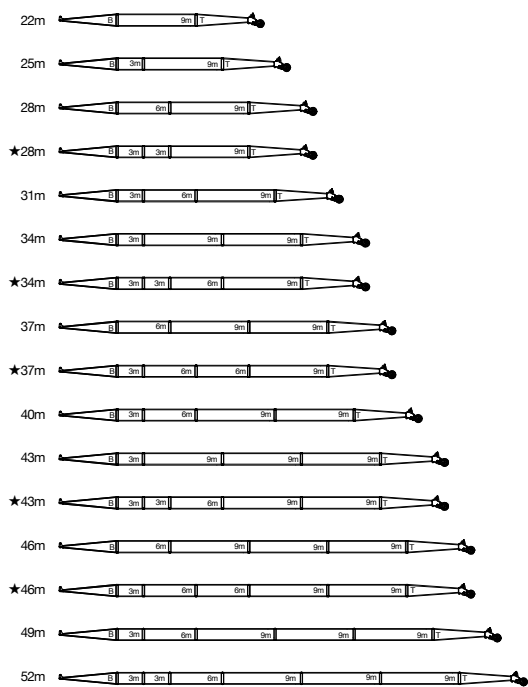

Note: The boom combinations with "★" are recommended for purchasing.

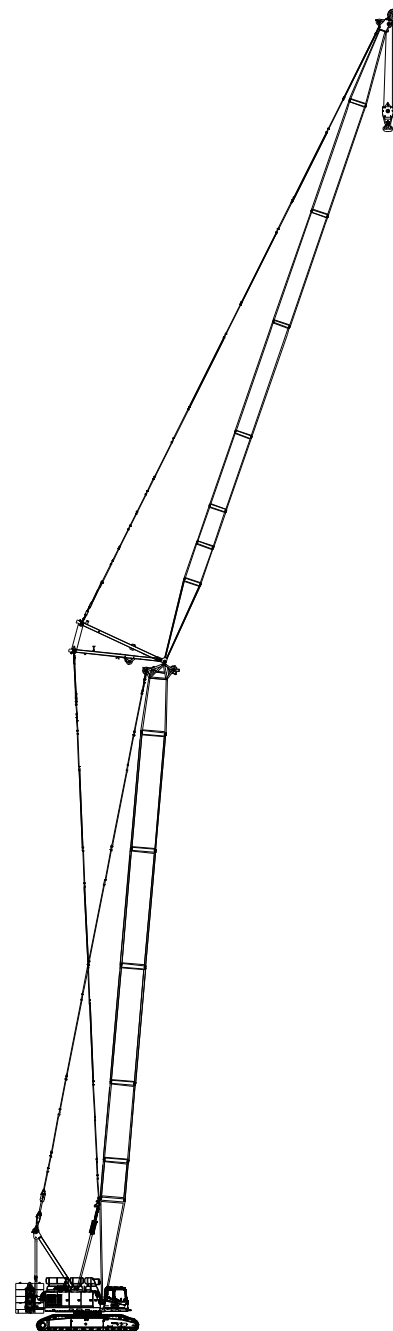
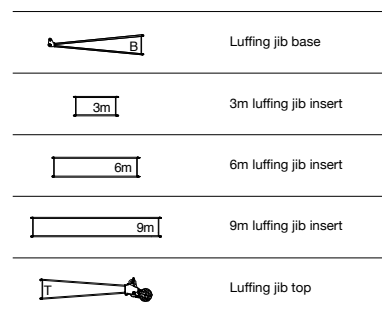

LJ Configuration  
(49m+52m)

### LJ Working Radius

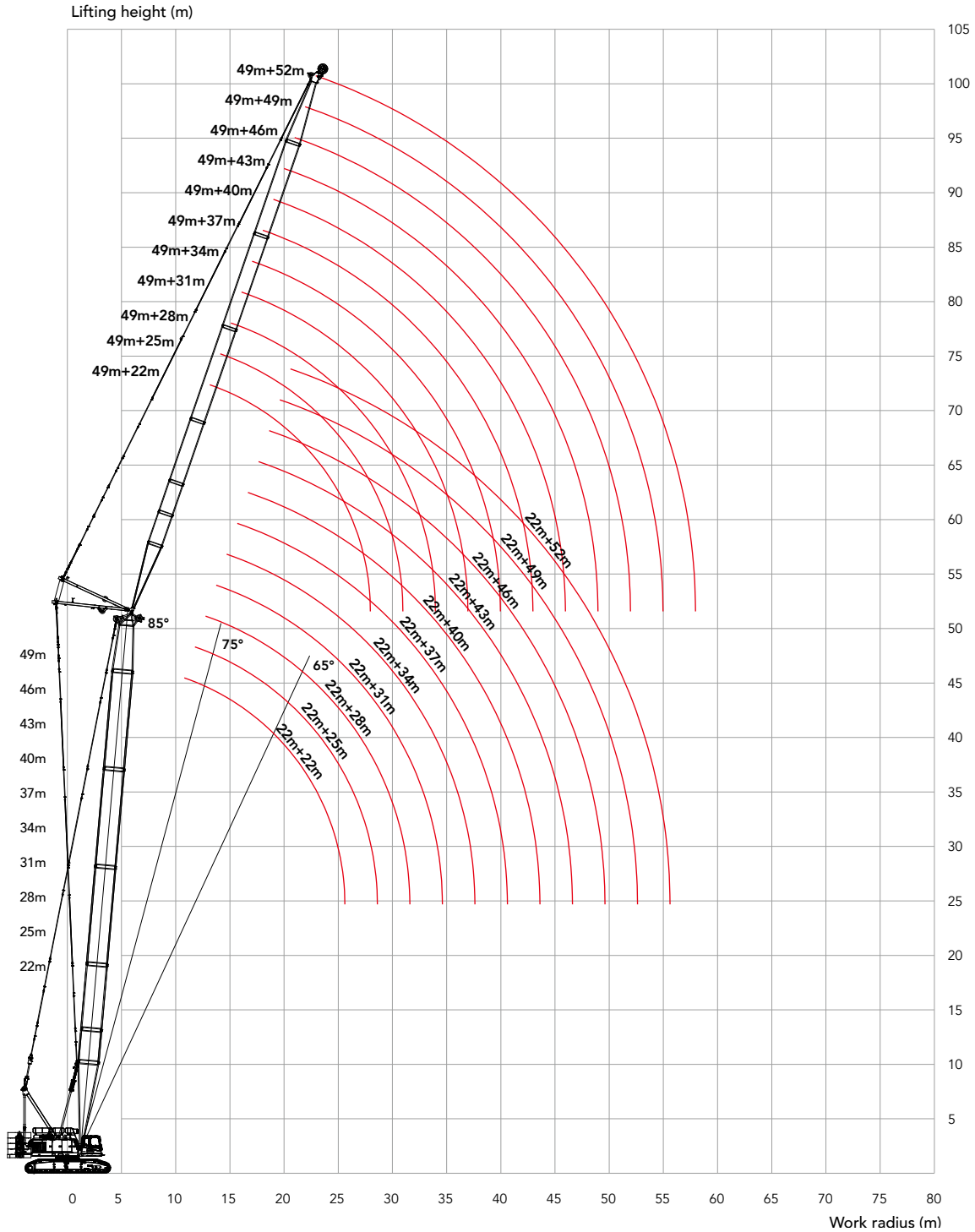



Unit: t

## LJ Load Chart

Note:

- 1.The rated load in the load chart is calculated complying with EN 13000.
- 2.The working radius is the horizontal distance from the load center to the swing center;
- 3.The actual lifting capacity must subtract the weight of hooks and other riggings from the rated capacity in the load chart.
- 4.The load value is calculated when the object is hung freely,without considering the influence of wind on the load, ground conditions and slope, operation speed and the influence of anyother negative factors over safe operation. Therefore, the operator bears the responsibility of making a judgement and decreasing the load and lowering speed.
- 5.All ratings are calculated when the machine is parking on firm and level ground with less than 1% gradient.
- 6.Parts of line as below are based on rated single line pull of 13.5t.
7. See the Operation Manual for the complete load charts of LJ and LJa configurations.

### Load chart –LJ( Load on luffing jib hook, Without extension jib hook) 1/12

Boom 22m, Boom angle 85°												
Boom length (m)	22	25	28	31	34	37	40	43	46	49	52	Boom length (m)
Radius (m)												Radius (m)
10	40.0											10
12	37.6	33.8	29.9	26.7								12
14	34.5	31.2	27.9	24.9	21.8	18.4						14
16	30.1	28.9	26.0	23.3	21.3	17.9	15.1	12.8	11.0			16
18	25.1	25.3	23.9	21.7	20.3	17.4	14.7	12.4	10.6	9.1	7.7	18
20	21.5	21.6	21.8	20.2	18.8	17.0	14.2	12.0	10.2	8.7	7.4	20
22	18.7	18.8	18.9	18.7	17.4	16.1	13.8	11.6	9.9	8.4	7.1	22
24	14.8	16.5	16.6	16.5	16.0	14.9	13.4	11.3	9.5	8.1	6.8	24
26		14.1	14.8	14.7	14.8	13.7	12.6	11.0	9.2	7.8	6.6	26
28			13.2	13.2	13.2	12.7	11.7	10.6	8.9	7.5	6.3	28
30			10.3	11.9	11.9	11.6	10.8	9.8	8.6	7.2	6.0	30
32				10.1	10.8	10.8	9.9	9.1	8.2	6.9	5.8	32
34					9.7	9.8	9.1	8.3	7.6	6.7	5.6	34
36					7.7	8.9	8.4	7.7	6.9	6.2	5.3	36
38						7.5	7.6	7.0	6.4	5.7	5.0	38
40							7.0	6.4	5.8	5.2	4.5	40
42								5.8	5.8	5.3	4.7	42
44									5.3	4.8	4.2	44
46										4.3	3.8	46
48										3.9	3.4	48
50											3.1	50
52												52
Counter weight( t)	55.3+20											Counter weight( t)
Parts of line	3	3	3	2	2	2	2	1	1	1	1	Parts of line

**LJ Load Chart**

Load chart -LJ( Load on luffing jib hook, Without extension jib hook) 2/12

Load chart -LJ( Load on luffing jib hook, Without extension jib hook) 2/12												
Boom 31m, Boom angle 85°												
Boom length (m) Radius (m)	22	25	28	31	34	37	40	43	46	49	52	Boom length (m) Radius (m)
12	37.1	33.3	28.8									12
14	32.1	31.1	27.6	23.9	20.2							14
16	27.6	27.5	26.0	23.2	19.8	16.8	14.3	12.2				16
18	24.3	24.2	24.1	21.8	19.4	16.4	13.9	11.9	10.2	8.7		18
20	21.7	21.6	21.3	20.6	18.9	16.1	13.6	11.6	9.9	8.4	7.2	20
22	19.5	19.4	19.2	19.1	17.6	15.7	13.2	11.2	9.6	8.1	6.9	22
24	17.7	17.6	17.4	17.3	16.4	15.1	12.9	10.9	9.3	7.9	6.7	24
26		16.0	15.9	15.6	15.0	14.1	12.6	10.6	9.0	7.6	6.4	26
28		13.3	14.2	14.0	13.6	13.0	12.1	10.3	8.7	7.3	6.2	28
30			12.4	12.4	12.3	11.9	11.2	10.1	8.4	7.1	5.9	30
32				11.0	11.0	10.9	10.4	9.4	8.2	6.8	5.7	32
34				9.8	9.9	9.9	9.6	8.8	7.9	6.6	5.5	34
36					8.9	9.0	8.8	8.0	7.3	6.4	5.3	36
38						8.0	8.0	7.4	6.7	6.0	5.1	38
40						7.2	7.3	6.8	6.2	5.5	4.8	40
42							6.6	6.2	5.7	5.0	4.3	42
44								5.7	5.2	4.6	3.9	44
46									4.7	4.2	3.5	46
48									4.2	3.7	3.2	48
50										3.3	2.8	50
52											2.5	52
54											2.1	54
Counter weight( t) Parts of line	55.3+20											Counter weight( t) Parts of line
	3	3	3	2	2	2	2	1	1	1	1	

Unit: t

## LJ Load Chart

Load chart –LJ( Load on luffing jib hook, Without extension jib hook) 3/12												
Boom 40m, Boom angle 85°												
Boom length (m) Radius (m)	22	25	28	31	34	37	40	43	46	49	52	Boom length (m) Radius (m)
12	32.0	28.5										12
14	28.8	27.0	24.3	21.1								14
16	25.1	24.7	23.0	20.7	17.8	15.3	13.2					16
18	21.9	21.8	21.5	19.6	17.5	15.0	12.9	11.1	9.6			18
20	19.7	19.4	19.3	18.2	16.8	14.7	12.6	10.8	9.3	8.0	6.8	20
22	17.8	17.5	17.3	16.9	15.7	14.5	12.4	10.6	9.1	7.7	6.6	22
24	16.0	15.9	15.7	15.5	14.6	13.6	12.1	10.3	8.8	7.5	6.4	24
26	14.6	14.4	14.3	14.2	13.5	12.7	11.8	10.1	8.6	7.3	6.2	26
28		13.2	13.0	12.8	12.4	11.8	11.0	9.8	8.3	7.1	6.0	28
30			11.7	11.5	11.3	10.9	10.3	9.6	8.1	6.8	5.8	30
32			10.3	10.4	10.2	10.0	9.6	9.0	7.9	6.6	5.6	32
34				9.2	9.3	9.1	8.8	8.4	7.7	6.4	5.4	34
36					8.4	8.3	8.1	7.8	7.4	6.2	5.2	36
38					7.5	7.6	7.4	7.3	6.9	6.1	5.0	38
40						6.8	6.8	6.7	6.4	5.7	4.8	40
42							6.2	6.2	5.9	5.2	4.5	42
44								5.6	5.4	4.7	4.1	44
46								5.1	5.0	4.3	3.7	46
48									4.4	3.9	3.3	48
50										3.5	3.0	50
52										3.2	2.7	52
54											2.3	54
Counter weight( t) Parts of line	55.3+20											Counter weight( t) Parts of line
	3	3	2	2	2	2	1	1	1	1	1	

## LJ Load Chart

Load chart -LJ( Load on luffing jib hook, Without extension jib hook) 4/12												
Boom 49m, Boom angle 85°												
Boom length (m) Radius (m)	22	25	28	31	34	37	40	43	46	49	52	Boom length (m) Radius (m)
14	24.4	22.3	20.3									14
16	22.7	21.0	19.3	17.5	15.4	13.4						16
18	20.1	19.5	18.2	16.7	15.1	13.2	11.5	10.0				18
20	18.0	17.9	16.9	15.8	14.5	13.0	11.3	9.8	8.5	7.4	6.4	20
22	16.3	16.1	15.7	14.6	13.7	12.6	11.1	9.6	8.3	7.2	6.2	22
24	14.7	14.5	14.4	13.5	12.8	12.0	10.8	9.4	8.1	7.0	6.0	24
26	13.5	13.3	13.1	12.4	11.9	11.2	10.4	9.2	7.9	6.8	5.8	26
28		12.1	11.9	11.5	11.0	10.5	9.8	9.0	7.7	6.6	5.6	28
30		10.9	10.7	10.4	10.1	9.7	9.2	8.6	7.5	6.4	5.4	30
32			9.7	9.5	9.3	9.0	8.6	8.1	7.4	6.2	5.3	32
34				8.6	8.5	8.3	8.0	7.6	7.1	6.1	5.1	34
36					7.7	7.6	7.4	7.1	6.7	5.9	4.9	36
38					7.0	7.0	6.8	6.6	6.3	5.7	4.8	38
40						6.4	6.3	6.1	5.9	5.6	4.6	40
42							5.7	5.6	5.5	5.2	4.5	42
44							5.3	5.2	5.1	4.9	4.2	44
46								4.8	4.7	4.5	3.9	46
48									4.3	4.1	3.5	48
50									4.0	3.7	3.1	50
52										3.3	2.8	52
54											2.5	54
56											2.2	56
Counter weight( t) Parts of line	55.3+20											Counter weight( t) Parts of line
	2	2	2	2	2	1	1	1	1	1	1	

Unit: t

## LJ Load Chart

Load chart –LJ( Load on luffing jib hook, Without extension jib hook) 5/12

Load chart –LJ( Load on luffing jib hook, Without extension jib hook) 5/12												
Boom 22m, Boom angle 75°												
Boom length (m) \ Radius (m)	22	25	28	31	34	37	40	43	46	49	52	Boom length (m) \ Radius (m)
18	30.9											18
20	27.3	27.3	26.0									20
22	24.5	24.4	24.3	21.9								22
24	22.2	22.0	22.1	20.8	18.6	15.4						24
26	20.1	20.0	20.1	19.4	17.9	15.2	12.7	10.7				26
28	16.9	18.2	18.3	18.1	16.6	14.9	12.4	10.4	8.8			28
30		15.7	16.5	16.5	15.5	14.3	12.2	10.2	8.5	7.2	6.0	30
32			14.5	14.7	14.3	13.3	11.9	9.9	8.3	7.0	5.8	32
34			12.2	13.1	13.3	12.3	11.3	9.7	8.1	6.7	5.6	34
36				11.5	12.1	11.4	10.4	9.4	7.9	6.5	5.4	36
38					10.8	10.4	9.6	8.7	7.7	6.4	5.2	38
40					9.1	9.5	8.8	8.1	7.3	6.2	5.1	40
42						8.7	8.1	7.4	6.7	6.0	4.9	42
44							7.4	6.8	6.2	5.5	4.7	44
46							6.7	6.2	5.7	5.0	4.3	46
48								5.6	5.1	4.5	3.9	48
50									4.7	4.1	3.5	50
52										3.6	3.1	52
54										3.3	2.8	54
56											2.4	56
Counter weight( t )	55.3+20											Counter weight( t )
Parts of line	3	3	2	2	2	2	1	1	1	1	1	Parts of line

## LJ Load Chart

Load chart -LJ( Load on luffing jib hook, Without extension jib hook) 6/12

Boom 31m, Boom angle 75°												
Boom length (m) Radius (m)	22	25	28	31	34	37	40	43	46	49	52	Boom length (m) Radius (m)
20	23.2											20
22	20.8	20.5	20.5									22
24	18.8	18.4	18.3	18.4								24
26	17.0	16.8	16.7	16.7	16.5	14.5						26
28	15.6	15.4	15.3	15.3	15.0	14.3	12.0					28
30	14.3	14.3	14.1	14.0	13.8	13.8	11.8	9.9	8.4			30
32		13.1	13.1	12.9	12.8	12.7	11.6	9.7	8.2	6.9	5.8	32
34		12.3	12.1	12.0	11.9	11.8	11.4	9.5	8.0	6.7	5.6	34
36			11.3	11.2	11.0	10.9	10.9	9.4	7.8	6.5	5.4	36
38				10.5	10.4	10.2	10.1	9.2	7.6	6.3	5.3	38
40					9.6	9.5	9.3	9.0	7.4	6.2	5.1	40
42					9.1	8.9	8.8	8.3	7.3	6.0	4.9	42
44						8.4	8.2	7.6	6.9	5.9	4.8	44
46							7.8	7.0	6.4	5.6	4.6	46
48							7.1	6.5	5.9	5.2	4.5	48
50								5.9	5.4	4.8	4.1	50
52									4.9	4.3	3.7	52
54									4.4	3.9	3.3	54
56										3.5	2.9	56
58											2.6	58
60											2.3	60
Counter weight( t )	55.3+20											Counter weight( t )
Parts of line	2	2	2	2	2	2	1	1	1	1	1	Parts of line

Unit: t

## LJ Load Chart

Load chart –LJ( Load on luffing jib hook, Without extension jib hook) 7/12

Load chart –LJ( Load on luffing jib hook, Without extension jib hook) 7/12												
Boom 40m, Boom angle 75°												
Boom length (m) \ Radius (m)	22	25	28	31	34	37	40	43	46	49	52	Boom length (m) \ Radius (m)
22	18.1											22
24	16.3	16.3										24
26	14.9	14.7	14.6	14.5								26
28	13.7	13.5	13.4	13.2	13.1	12.9						28
30	12.6	12.5	12.4	12.1	12.0	11.8	11.2					30
32	11.7	11.5	11.4	11.3	11.1	10.9	10.7	9.3	7.9			32
34		10.6	10.6	10.4	10.2	10.1	9.9	9.2	7.7	6.5		34
36		9.9	9.8	9.7	9.5	9.4	9.2	9.0	7.6	6.4	5.3	36
38			9.1	9.0	8.9	8.7	8.6	8.4	7.4	6.2	5.2	38
40				8.4	8.3	8.2	8.1	7.9	7.3	6.1	5.1	40
42				7.9	7.8	7.6	7.5	7.4	7.2	5.9	4.9	42
44					7.3	7.2	7.0	6.9	6.8	5.8	4.8	44
46						6.8	6.6	6.4	6.3	5.7	4.6	46
48							6.3	6.1	5.9	5.5	4.5	48
50							5.8	5.7	5.5	5.3	4.4	50
52								5.4	5.3	4.8	4.1	52
54									4.9	4.4	3.8	54
56									4.6	4.0	3.4	56
58										3.6	3.0	58
60											2.7	60
62											2.4	62
Counter weight( t )	55.3+20											Counter weight( t )
Parts of line	2	2	2	2	1	1	1	1	1	1	1	Parts of line

**LJ Load Chart**

Load chart -LJ( Load on luffing jib hook, Without extension jib hook) 8/12

Load chart -LJ( Load on luffing jib hook, Without extension jib hook) 8/12												
Boom 49m, Boom angle 75°												
Boom length (m) Radius (m)	22	25	28	31	34	37	40	43	46	49	52	Boom length (m) Radius (m)
24	14.5											24
26	13.0	12.9										26
28	12.0	11.9	11.6	11.5								28
30	11.0	10.8	10.8	10.5	10.4							30
32	10.2	10.0	9.9	9.7	9.5	9.4	9.2					32
34	9.5	9.2	9.1	9.0	8.8	8.6	8.4	8.3				34
36		8.7	8.5	8.4	8.2	8.0	7.8	7.7	7.1	6.0		36
38		8.0	7.9	7.7	7.6	7.5	7.2	7.0	6.9	5.9	5.0	38
40			7.5	7.3	7.1	6.9	6.7	6.6	6.5	5.8	4.9	40
42				6.8	6.6	6.5	6.4	6.2	6.0	5.7	4.7	42
44				6.3	6.2	6.1	5.9	5.7	5.6	5.4	4.6	44
46					5.8	5.7	5.5	5.3	5.2	5.0	4.5	46
48						5.4	5.2	5.0	4.9	4.7	4.4	48
50						5.1	4.8	4.7	4.6	4.4	4.2	50
52							4.6	4.4	4.3	4.2	3.9	52
54								4.2	4.0	3.9	3.8	54
56								3.9	3.8	3.6	3.5	56
58									3.6	3.4	3.2	58
60										3.2	3.0	60
62											2.8	62
64											2.4	64
Counter weight( t )	55.3+20											Counter weight( t )
Parts of line	2	1	1	1	1	1	1	1	1	1	1	Parts of line



Unit: t

## LJ Load Chart

Load chart –LJ( Load on luffing jib hook, Without extension jib hook) 9/12

Boom 22m, Boom angle 65°												
Boom length (m) Radius (m)	22	25	28	31	34	37	40	43	46	49	52	Boom length (m) Radius (m)
24	22.4											24
26	20.3	20.2										26
28	18.6	18.4	18.3									28
30	17.1	16.9	16.8	16.7								30
32	15.8	15.7	15.6	15.4	15.3							32
34		14.5	14.4	14.3	14.2	13.1						34
36			13.5	13.3	13.2	13.0	10.7	8.9				36
38			12.6	12.4	12.3	12.2	10.6	8.8	7.3			38
40				11.7	11.6	11.5	10.6	8.7	7.1	5.9		40
42					10.9	10.8	9.9	8.5	7.0	5.8	4.8	42
44					9.8	10.0	9.1	8.2	6.9	5.7	4.6	44
46						9.2	8.4	7.6	6.8	5.5	4.5	46
48							7.7	7.0	6.4	5.4	4.4	48
50								6.4	5.8	5.1		50
52								5.9	5.3			52
Counter weight( t )	55.3+20											Counter weight( t )
Parts of line	2	2	2	2	2	1	1	1	1	1	1	Parts of line

Load chart –LJ( Load on luffing jib hook, Without extension jib hook) 10/12

Boom 31m, Boom angle 65°												
Boom length (m) Radius (m)	22	25	28	31	34	37	40	43	46	49	52	Boom length (m) Radius (m)
28	15.7											28
30	14.4	14.3										30
32	13.4	13.3	13.1									32
34	12.4	12.2	12.1	11.9								34
36	11.5	11.4	11.3	11.1	10.9							36
38		10.7	10.5	10.4	10.2	10.2						38
40			9.8	9.8	9.6	9.4	9.3	8.4				40
42			9.2	9.1	9.0	8.9	8.7	8.3	6.9			42
44				8.6	8.5	8.4	8.1	8.0	6.8	5.6		44
46					7.9	7.9	7.7	7.5	6.7	5.5	4.5	46
48						7.4	7.2	7.1	6.6	5.4	4.4	48
50							7.0	6.8	6.7	6.5	5.3	50
52								6.4	6.3	6.2	5.2	52
54									5.9	5.8	5.1	54
56									5.6	5.4	4.8	56
58										5.0	4.4	58
60											4.0	60
Counter weight( t )	55.3+20											Counter weight( t )
Parts of line	2	2	1	1	1	1	1	1	1	1	1	Parts of line

**LJ Load Chart****Load chart -LJ( Load on luffing jib hook, Without extension jib hook) 11/12**

Boom 40m, Boom angle 65°												
Boom length (m) Radius (m)	22	25	28	31	34	37	40	43	46	49	52	Boom length (m) Radius (m)
32	11.4											32
34	10.5	10.4										34
36	9.7	9.7	9.5									36
38	9.1	8.9	8.9	8.6								38
40	8.5	8.4	8.2	8.0	7.9							40
42		7.8	7.7	7.6	7.4	7.2	7.0					42
44			7.2	7.1	6.9	6.8	6.6	6.4				44
46				6.7	6.5	6.3	6.2	6.0	5.9			46
48				6.3	6.1	6.0	5.8	5.6	5.5	5.3		48
50					5.8	5.7	5.4	5.3	5.1	5.0	4.3	50
52						5.3	5.1	5.0	4.8	4.6	4.2	52
54						4.9	4.8	4.6	4.5	4.3	4.1	54
56							4.6	4.4	4.2	4.1	3.9	56
58								4.2	4.0	3.9		58
60								3.9	3.8			60
Counter weight( t ) Parts of line	55.3+20										Counter weight( t ) Parts of line	
	1	1	1	1	1	1	1	1	1	1	1	

**Load chart -LJ( Load on luffing jib hook, Without extension jib hook) 12/12**

Boom 49m, Boom angle 65°											
Boom length (m) Radius (m)	22	25	28	31	34	37	40	43	46		Boom length (m) Radius (m)
36	8.0										36
38	7.6	7.4									38
40	7.0	6.8	6.7								40
42	6.6	6.4	6.3	6.0							42
44		6.0	5.9	5.6	5.5	5.3					44
46		5.6	5.5	5.4	5.1	4.9	4.7				46
48			5.2	5.0	4.9	4.6	4.4	4.2			48
50				4.7	4.5	4.3	4.1	3.9	3.8		50
52				4.5	4.3	4.1	3.8	3.7	3.5		52
54					3.9	3.7	3.6	3.4	3.3		54
56						3.5	3.4	3.2			56
58						3.3	3.2				58
Counter weight( t ) Parts of line	55.3+20										Counter weight( t ) Parts of line
	1	1	1	1	1	1	1	1	1	1	





## Zhejiang Sany Equipment Co.,LTD

SANY Crawler Crane Industrial Park, No. 2188 Daishan Road, Wuxing District, Huzhou City,  
Zhejiang Province, P. R. China Zip 313028  
Consulting [sanycrane@sanygroup.com](mailto:sanycrane@sanygroup.com) (Crane BU) / [crd@sany.com.cn](mailto:crd@sany.com.cn) (IHQ)  
After-sales Service 0086-400 6098 318

**Reminder:**

Any change in the technical parameters and configuration due to product modification or upgrade may occur without prior notice.  
The machine in the picture may include additional equipment. This brochure is for reference only, and goods in kind shall prevail.  
Copyright at SANY. No part of this brochure may be copied or used for any purpose without written approval from SANY.

© Edited in April 2023

