



# SCC1000A-7

## Crawler Crane

### 100 Tons Lifting Capacity

Quality Changes the World



**Max. lifting moment: 425t · m**  
**Max. boom length: 64m**  
**Max. fixed jib combination: 52m+18m**

The parameters, pictures and standard/optional equipment are only for reference in this brochure, the actual machine is based on the effective price list and contract.

■ [www.sanyglobal.com](http://www.sanyglobal.com)



## Crawler Crane Series SCC1000A-7

P03

Main  
Characteristics

- Product Specification
- Safety Device

P09

Technical  
Parameters

- Major Performance & Specifications
- Outline Dimension
- Transport Dimension
- Transport Plan

P17

Cofigurations

- H Configuration
- FJ Configuration



**SCC1000A-7**  
**SANY CRAWLER CRANE**  
**100 TONS LIFTING CAPACITY**

QUALITY CHANGES THE WORLD

## Main Characteristics

- Page 04 Product Specification
- Page 06 Safety Device



## Product Specification



### Engine

- WEICHAI WP7 Diesel Engine
- Type: 6-cylinder vertical in-line, direct injection, turbo-charger, watercooled, intercooler. Compliant with Chinese Non-road Tier III emission standard;
- Displacement: 7.47L;
- Rated power: 199kW/2300rpm;
- Operation power: 199kW/1800rpm;
- Max. output torque: 1200N·m/(1200~1500)rpm;
- Starter device: 24V-5.0kW;
- Battery: two 12V large battery in serial connection;
- Fuel tank: 400L.

### Electrical Control System

- Self-developed SYIC-II integrated control system is adopted with higher integration, precise operation and reliable quality;
- Control system consists of power system, engine system, main control system, LML system, auxiliary system and safety monitoring system. CAN BUS is used for data communication between controller, monitor and the engine;
- Monitor: the working parameters and status are shown on the monitor, such as the engine speed, fuel volume, engine oil pressure, servo pressure, engine working hours, lifting conditions and boom angle;
- The Sky Eye system and the function to get on/off the trailer by remote control are offered optionally.

### Hydraulic System

- Main pumps: two open variable displacement piston pumps are adopted to provide oil supply for main actuators of main machine;
- Gear pump: dual-gear pump for swing, radiator and control circuit;
- Control: main pump adopts electrically-controlled positive flow control; winch motor adopts piston motor of variable displacement. The operating components are two cross-shaped hydraulic control handles and one dual-travel-pedal control valve, to control various actuators proportionally;
- Max. pressure of system: 33MPa;
- Main/aux. load hoist, luffing and travel system: 33MPa;
- Swing system: 24MPa;
- Control system: 5MPa;
- Hydraulic Tank Capacity:460L.



## Product Specification

### Main and Aux. Load Hoist Mechanism

- Main and aux. Load hoist winches are driven separately by motor via gearbox. Operating winch handle can control the winch to rotate to two directions, which are lifting and lowering of hook. Excellent inching function is equipped on the machine;
- Drums with fold-line grooves can ensure the wire rope reeved in order in multilayers;
- Free fall for main/aux. load hoist is offered as optional.

Main/Aux. Load Hoisting Mechanism	Drum diameter	630mm
	Single rope speed	0~130m/min
	Wire rope diameter	26mm
	Wire rope length of main/aux. hoist	240m/180m
	Rated single line pull	12.3t

### Boom Hoist Mechanism

- Boom hoist winches are driven separately by motor via gearbox. Operating winch handle can control the winch to rotate to two directions, which are lifting and lowering of boom;
- Drums with fold-line grooves can ensure the wire rope reeved in order in multilayers.

Boom hoist mechanism	Drum diameter	420mm
	Rope speed on the outermost work layer	0~70m/min
	Wire rope diameter	20mm
	Wire rope length of boom hoist	140m

### Swing Mechanism

- Swing brake adopts wet, spring loaded, normally-closed brake, and braking through spring force;
- The swing system is fitted with integrated cushion valve and free slipping function, to ensure steady start and control;
- Swing drive: internal engaged swing drive with 360° swing range, and the max. swing speed is 1.7rpm;
- Swing lock: mechanical lock can ensure the upperworks locked securely after work or during transport;
- Swing ring: single row ball bearing.

### Cab and Control

- Novel operator's cab with fashionable profile, nice interior and large of window glass. There are low and high-beam lights, back-view mirror, A/C, radio and other functions. The layout of seat, handles, control buttons are designed with ergonomic principles to make operation more comfortable;
- Cab layout: Large integrated touch screen, man-machine interaction interface are more perfect;
- Armrest box: on the left and right armrest box are control handles, electrical switches, emergent stop and ignition switch. The armrest box can be adjusted along with the seat;
- Seat: multi-way and multi-level floating adjustable seat with unload switch;
- A/C: cool and heat air; optimized air channels and vents;
- Multiple cameras can present on the monitor at the same time to realize backing video, real-time monitoring of wire rope on each winch, conditions behind the counterweight and surrounding the machine.

### Counterweight

- Counterweight tray and blocks are piled up for easier assembly and transport;
- Rear counterweight: total weight of 33.5t, including counterweight tray 8.7t×1, left counterweight block I 4t×1, right counterweight block I 4t×1, left counterweight block II 4.2t×2, right counterweight block II 4.2t×2;
- Carbody counterweight: 5.5t×2 at the front and rear of carbody.

### Upperworks

- High-strength steel weld framework, with no torsion or deformation. The parts are laid out in the way that is easier for maintenance and service.

## Product Specification



### Lowerworks

- Independent travel driving units are adopted for each side of the crawler, to realize straight walking and turning driven by travel motor through gearbox and drive wheel.

### Crawler Extension and Retraction

- The crawlers can extend and retract via cylinders. During Work Mode, the crawlers must be extended, and retracted during transport with crawlers on.

### Crawler Tensioning

- The jack is used to push the guide wheel and insert the shim to adjust crawler tension.

### Track Pad

- High-strength alloy cast steel track pad can prolong the service life. They are 850mm wide, and the total amount is 53pcs x 2.

### Outrigger

- Outrigger cylinder is offered as standard to facilitate the track frame disassembly during jobsite transfer.

### Operating Equipment

- All chords are high-strength steel tubes, and the boom/jib top sheaves are made of high-strength anti-wearing Nylon material protecting wire rope. The hooks are installed with milled welded steel sheave. High-strength pendant bars for luffing makes assembly/disassembly and transport easier.

### Boom

- Lattice structure. The chord adopts high-strength structural tube and each section is connected through pins;
- Basic boom: 6.5m boom top + 6.5m boom base;
- Boom insert: 3m x 1, 6m x 2, 9m x 4;
- Boom length: 13m~64m.

### Fixed Jib

- Lattice structure. The chord adopts high-strength structural tube and each section is connected through pins;
- Basic boom: 4.5m boom top+4.5m boom base;
- Boom insert: 4.5m x 2;
- Boom length: 9m~18m;
- Longest boom + jib: 52m+18m.

### Extension Jib

- The extension jib is a welded structure connected to the boom tip by pins, used for auxiliary hook;
- Extension jib length: 1.2m.

### Hook Block

- 100t hook block, five sheaves;
- 70t hook block, three sheaves;
- 25t hook block, one sheave;
- 13.5t ball hook.

### Hook Limitation Height

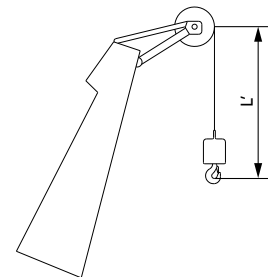
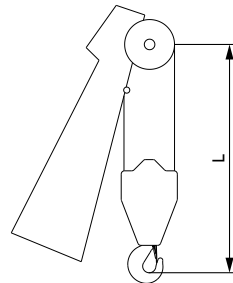

Hook	L
100t	3.5m
70t	3.3m
25t	3.2m

Hook	L'
13.5t	3.1m



## Safety Device

### Assembly Mode/Work Mode Switch

- In Assembly Mode, the over-hoist protection, boom limit, LML are all off work to facilitate crane assembly;
- In Work Mode, all safety devices activate to protect the operation.

### Emergent Stop

- In emergent situation, this button is pressed down to cut off the power supply of whole machine and all actions stop.

### Load Moment Limiter (LML)

- It is an independent computerized safety control system. LML can automatically detect the load weight, work radius and boom angle, and present on the display the rated load, actual load, work radius and boom angle. In normal operation, the LML can make a judgment and cut off automatically if the crane moves towards dangerous direction. It can also perform as a black box to record the lifting information;
- Composition: indicator, boom angle sensor and force sensor.

### Over-hoist Protection of the Main/Auxiliary Hooks

- Over-hoist protection device comprises of limit switch and weight on boom top, which prevents the hook lift up too much. When the hook lifts up to the limit height, the limit switch activates, buzzer on the left control panel sends alarm, and failure indicator light starts to flash, the hook hoisting action is cut off automatically.

### Over-release Protection Device of the Main/Auxiliary Winch

- It is comprised of activator in the drum and proximity switch to prevent over release of wire rope. When the rope is paid out close to the last three wraps, the limit switch acts, and the system sends alarm through buzzer and show the alarm on the instrument panel, automatically cutting off the winch action.

### Function Lock

- If the function lock level is not in work position, all the other handles won't work, which prevents any mis-operation caused by accidental collision.

### Drum Lock

- Hydraulically controlled lock is installed for boom hoist drum, which needs to unlock by switch before operation, in order to prevent mis-operation of handles and ensure safety during non-work time.

### Swing Lock

- Swing Lock can lock the machine at four positions, front and back, left and right.

### Boom Limit Device

- When the boom elevation angle reaches the max. Angle the buzzer sounds and boom action cut off. This protection is two-stage control ensured by both LML system and travel switch.

### Back-stop Device

- Its major components are nesting tubes and spring, in order to buffer the boom backlash and prevent further tipping back.

### Boom Angle Indicator

- Pendulum angle indicator is fixed on the side of boom base close to the cab, so as to provide convenience to the operator.

### Hook Latch

- The lifting hook is installed with a baffle plate to prevent wire rope from falling off.

## Safety Device



### Monitoring System

- Remote Monitoring system is a standardized offering to provide functions like GPS locating, GPRS data transfer, machine status inquiry and statistics, operating data monitoring and analysis, remote diagnosis of failures.

### Tri-color Load Indicator

- The load indication light has three colors, green, yellow and red, and the real time load status is presented on the display. When the actual load is smaller than 90% of rated load, the green light is on; when the actual load is larger than 90% and smaller than 100%, the yellow light is on, the alarm light flashes and sends out intermittent sirens; when the actual load reaches 100% of rated load, the red light on, the alarm light flashes and sends out continuous sirens. When the actual load reaches 102% of rated load, the system will automatically cut off the crane's dangerous operation.

### Audio-Visual Alarm

- When the engine is working, the light flashes; when the machine is traveling or swinging, it sends out siren.

### Swing Indicator Light

- The swing indicator light flashes during traveling or swing.

### Illuminating Light

- The machine is equipped with, short-beam light in front of machine, front angle adjustable far-beam, lamps in operator's cab, lighting devices for night operation, so as to increase the visibility during work.

### Rearview Mirror

- It is installed on the left of the operator's cab for monitoring the rear part of the machine.

### Pharos

- Pharos is mounted on the top of boom/jib to indicating the height.

### Anemometer

- It is mounted on the top of boom/jib, and displayed on the monitor in the cab.

### Electronic Level Gauge

- It displays the tipping angle of crane on the monitor in real time, protecting the machine from dangerous situation.

### Seat Interlock

- If the operator leaves the seat, all control handles will be locked immediately to prevent any mis-operation due to accidental collision.

### Engine Power Limit Load Adjustment and Stalling Protection

- The controller monitors the engine power to prevent engine getting stuck and stalling.

### Engine Status Monitoring

- The engine status will be presented, such as engine coolant temperature, fuel volume, total work hours, engine oil pressure, engine speed, battery charging, voltage.





**SCC1000A-7**  
**SANY CRAWLER CRANE**  
**100 TONS LIFTING CAPACITY**

QUALITY CHANGES THE WORLD

## Technical Parameters

- Page 10 Major Performance & Specifications
- Page 11 Outline Dimension
- Page 12 Transport Dimension
- Page 16 Transport Plan

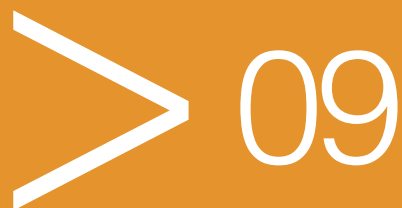

## Major Performance & Specifications

Major Performance & Specifications of SCC1000A-7			
Performance Indicators		Unit	Parameter
Configuration	Max. rated lifting capacity	t	100
	Boom length	m	13~64
	Boom luffing angle	°	0~80
FJ	Jib length	m	9~18
	Longest boom + longest jib	m	52+18
	Jib angle	°	15, 30
Speed	Rope speed of main/aux. winch	m/min	0~135
	Rope speed of boom hoist winch	m/min	0~70
	Swing speed	rpm	0~1.7
	Travel speed	km/h	0~1.6
Wire rope	Main hoist wire rope: diameter × length	φ mm×m	26×240
	Aux. hoist wire rope: diameter × length	φ mm×m	26×180
	Rated single line pull of main/aux. load hoist wire rope	t	12.3
Engine	Model/Displacement	/L	WEICHAH WP7/7.47
	Rated power/Revolution speed	kW/ rpm	199/2300
Transport	Weight of machine with basic boom	t	91.8
	Rear counterweight	t	33.5
	Carbody counterweight	t	5.5×2
	Transport weight of basic machine (with crawler frames and boom base)	t	44.5
	Transport weight of basic machine (without crawler frame)	t	25.5
	Machine transport dimension (with crawlers and boom base) L×W×H	mm	13300×3490×3460
	Machine transport dimension (without crawlers and boom base) L×W×H	mm	8200×3000×3050
Other specifications	Average ground pressure (basic boom)	MPa	0.089
	Gradeability	%	30

Unit: mm

## Outline Dimension

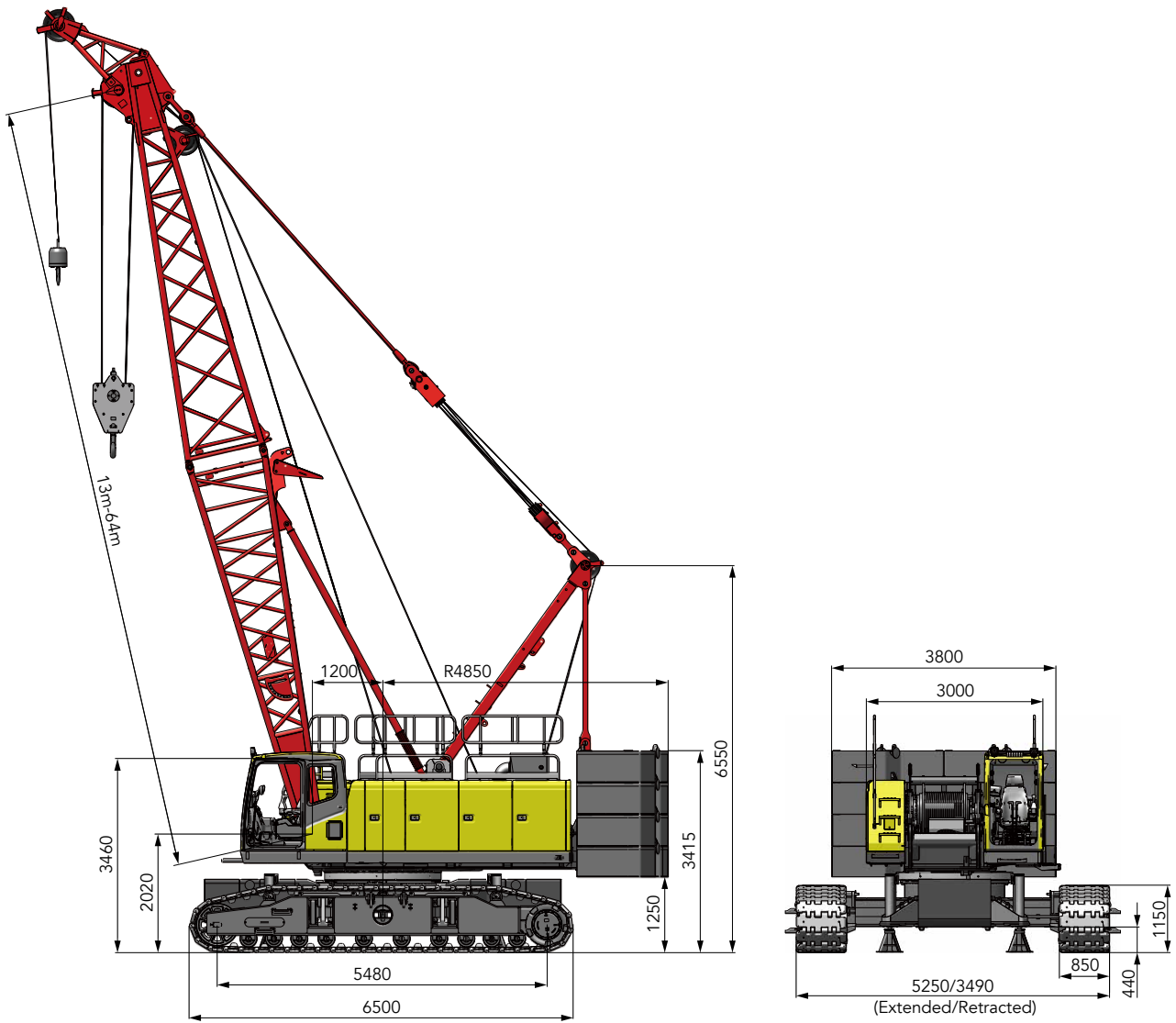

## Transport Dimension

Note:

- ① . The transport dimensions of each part in the table are schematic, not proportional to the real parts. The dimensions are designed value without package considered.
- ② . The weight is designed value that the actual manufactured part may deviate a little.
- ③ . The design value of the parts may differ due to product upgrade, the latest values shall prevail.

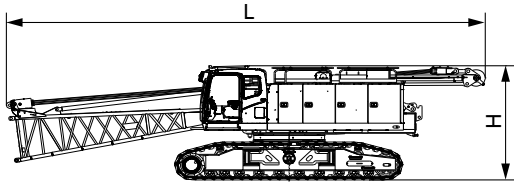

### Basic Machine 1 (with boom base and crawlers) ×1

Length(L)	13.30m
Width(W)	3.49m
Height(H)	3.46m
Weight	44.5t

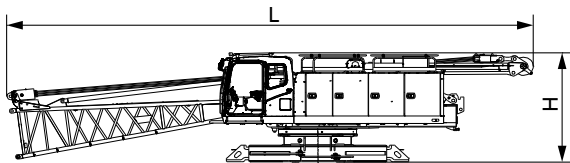

### Basic Machine 2 (with boom base) ×1

Length (L)	13.30m
Width (W)	3.00m
Height (H)	3.06m
Weight	25.5t

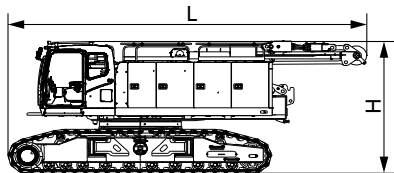

### Basic Machine 3 (with crawlers) ×1

Length (L)	8.73m
Width (W)	3.49m
Height (H)	3.46m
Weight	43.0t

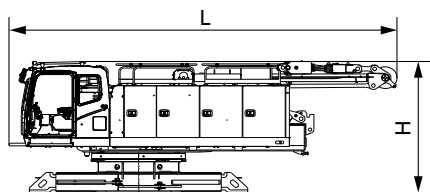

### Basic Machine 4 ×1

Length(L)	8.20m
Width(W)	3.00m
Height(H)	3.06m
Weight	24.0t

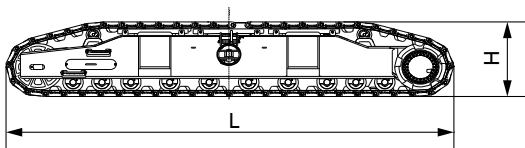

### Crawlers ×2

Length(L)	6.50m
Width(W)	1.03m
Height(H)	1.14m
Weight	9.5t

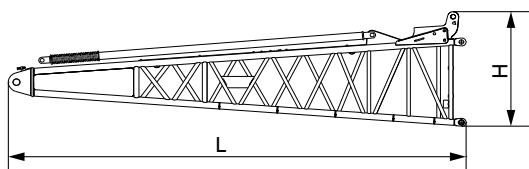

### Boom Base ×1

Length(L)	6.69m
Width(W)	1.78m
Height(H)	1.83m
Weight	1.52t

## Transport Dimension

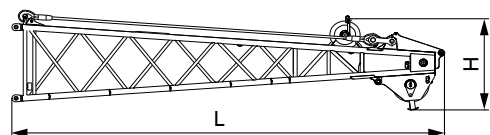

Boom Top	×1
Length(L)	7.13m
Width(W)	1.51m
Height(H)	1.64m
Weight	1.36t

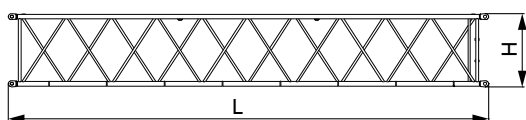

9m Boom Insert	×4
Length (L)	9.14m
Width (W)	1.51m
Height (H)	1.53m
Weight	1.08t

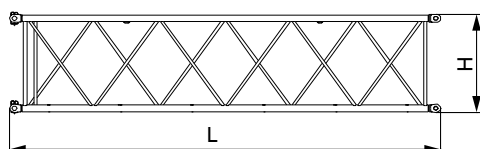

6m Boom Insert	×2
Length (L)	6.14m
Width (W)	1.51m
Height (H)	1.53m
Weight	0.82t

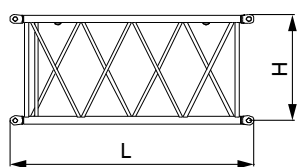

3m Boom Insert	×1
Length(L)	3.14m
Width(W)	1.51m
Height(H)	1.53m
Weight	0.61t

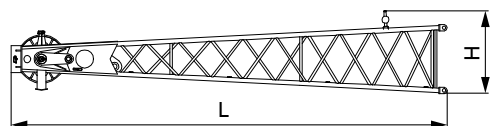

Fixed Jib Top	×1
Length(L)	4.93m
Width(W)	0.87m
Height(H)	0.92m
Weight	0.31t

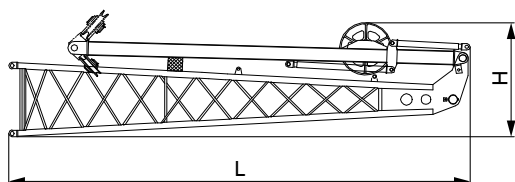

Fixed Jib Base and Strut	×1
Length(L)	4.75m
Width(W)	0.87m
Height(H)	1.18m
Weight	0.75t

## Transport Dimension

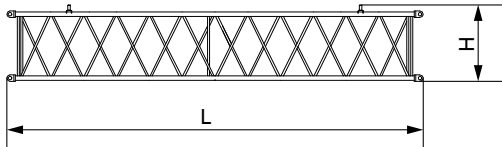

### 4.5m Fixed Jib Insert

×2

Length(L)	4.57m
Width(W)	0.87m
Height(H)	0.83m
Weight	0.24t

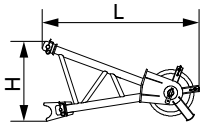

### Extension Jib

×1

Length (L)	1.83m
Width (W)	0.89m
Height (H)	0.95m
Weight	0.19t

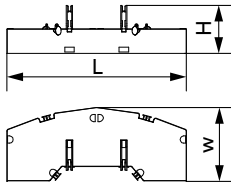

### Counterweight Tray

×1

Length (L)	3.80m
Width (W)	1.56m
Height (H)	1.01m
Weight	8.7t

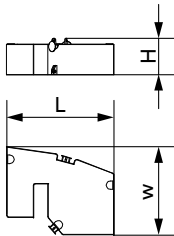

### Left Counterweight Block I

×1

Length(L)	1.90m
Width(W)	1.56m
Height(H)	0.64m
Weight	4.0t

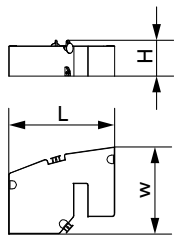

### Right Counterweight Block I

×1

Length(L)	1.90m
Width(W)	1.56m
Height(H)	0.64m
Weight	4.0t

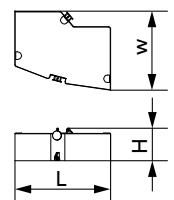

### Left Counterweight Block II

×2

Length(L)	1.90m
Width(W)	1.56m
Height(H)	0.64m
Weight	4.2t

## Transport Dimension

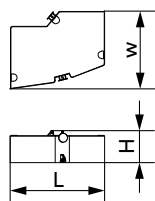

### Right Counterweight Block II ×2

Length(L)	1.90m
Width(W)	1.56m
Height(H)	0.64m
Weight	4.2t

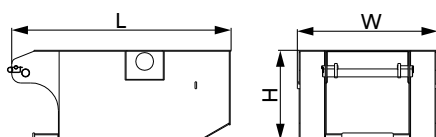

### Carbody Counterweight ×2

Length (L)	1.96m
Width (W)	1.45m
Height (H)	0.70m
Weight	5.5t

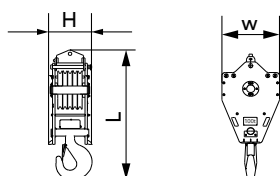

### 100t Hook ×1

Length (L)	2.09m
Width (W)	0.85m
Height (H)	0.65m
Weight	1.36t

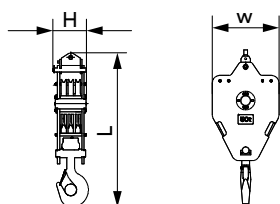

### 70t Hook ×1

Length(L)	1.95m
Width(W)	0.90m
Height(H)	0.45m
Weight	1.04t

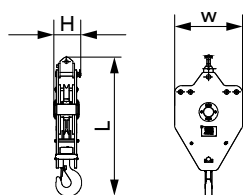

### 25t Hook ×1

Length(L)	1.80m
Width(W)	0.86m
Height(H)	0.33m
Weight	0.53t

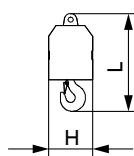

### 13.5t Ball Hook ×1

Length(L)	0.95m
Width(W)	0.37m
Height(H)	0.37m
Weight	0.34t

## Transport Plan

### With crawlers

Trailer 1	
Part(s)	<ul style="list-style-type: none"> <li>Basic machine</li> </ul>
Weight	<ul style="list-style-type: none"> <li>44.5t (without the optional outrigger)</li> </ul>

Note: The machine can be transported without crawlers and boom base. Without crawlers, the basic machine meets 3m transport width.

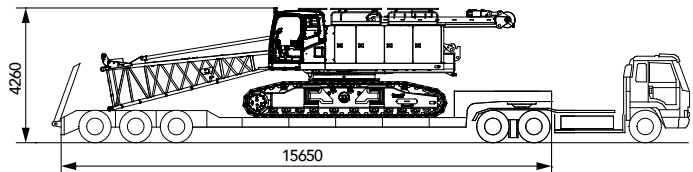

Trailer 2	
Part(s)	<ul style="list-style-type: none"> <li>9m boom insert × 2</li> <li>6m boom insert × 2</li> <li>Extension jib × 1</li> <li>4.5m fixed jib insert × 2</li> <li>Left counterweight block II × 2</li> <li>Right counterweight block II × 2</li> <li>100t hook × 1</li> <li>70t hook × 1</li> <li>25t hook × 1</li> <li>13.5t hook × 1</li> </ul>
Weight	<ul style="list-style-type: none"> <li>24.8t</li> </ul>

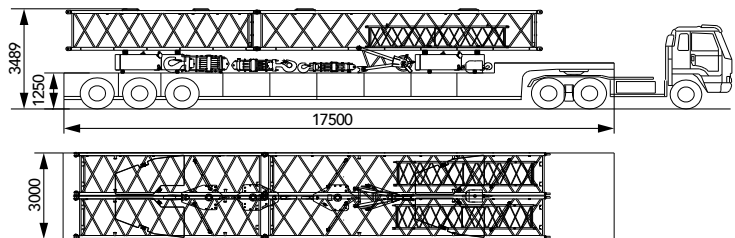

Trailer 3	
Part(s)	<ul style="list-style-type: none"> <li>9m boom insert × 2</li> <li>3m boom insert × 1</li> <li>Boom top × 1</li> <li>Fixed jib base × 1</li> <li>Fixed jib top × 1</li> <li>Counterweight tray × 1</li> <li>Left counterweight block I × 1</li> <li>Right counterweight block I × 1</li> <li>Carbody counterweight block × 2</li> </ul>
Weight	<ul style="list-style-type: none"> <li>32.8t</li> </ul>

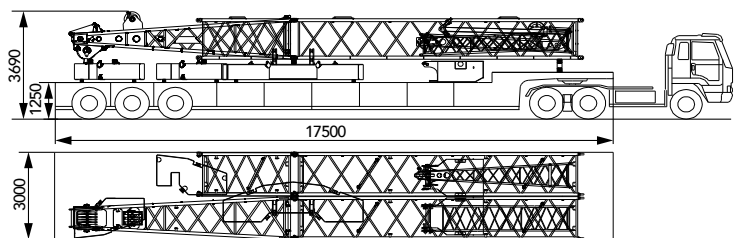

Note: The transport plan above is for reference only. The transport mode shall be subject to the actual boom sections, transport regulations, and other conditions.





**SCC1000A-7**  
**SANY CRAWLER CRANE**  
**100 TONS LIFTING CAPACITY**

QUALITY CHANGES THE WORLD

## Coffiguration

- Page 20 H Configuration
- Page 24 FJ Configuration

> 17

**Combination**

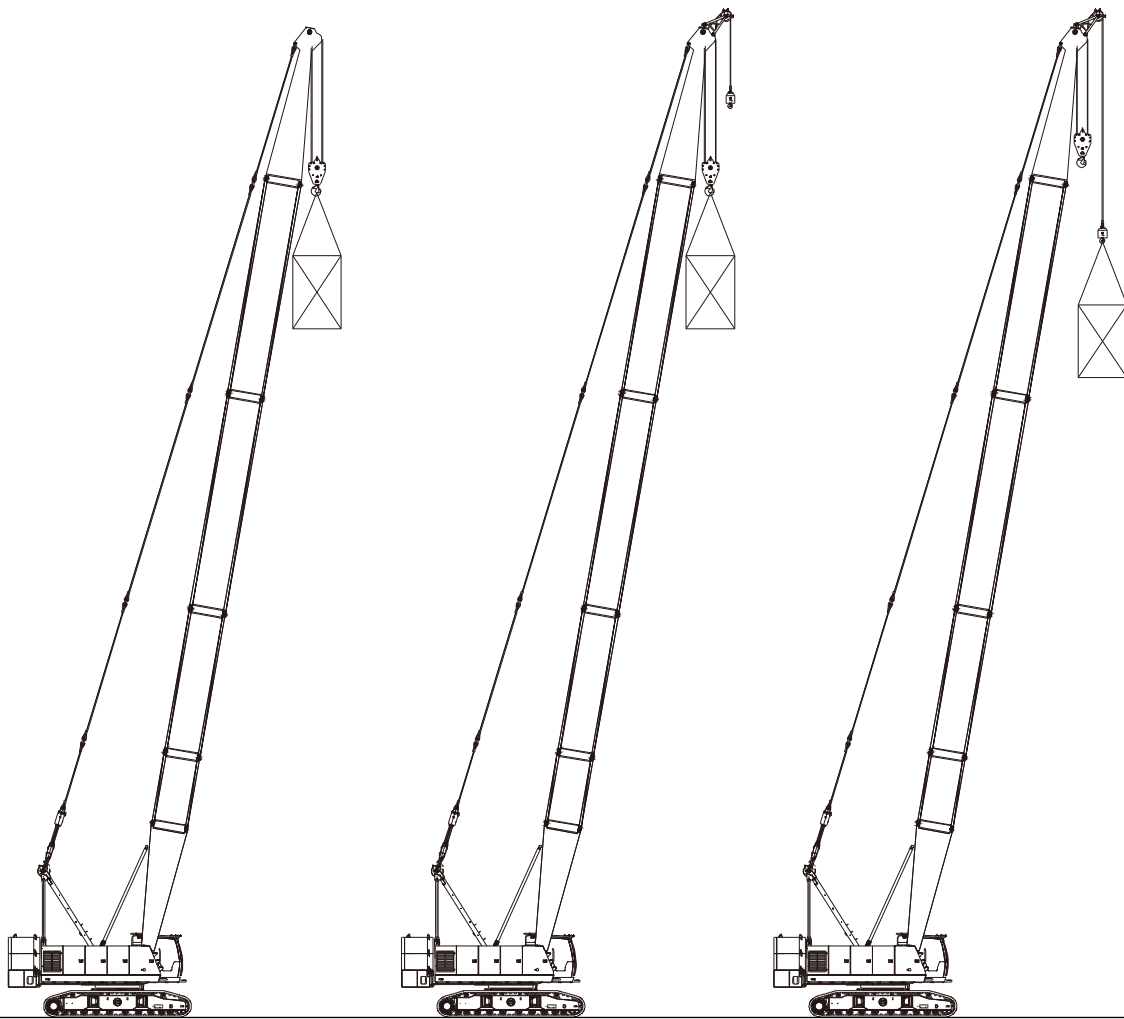

**H Configuration**

**HCm Configuration**  
(double hooks, load on main hook)

**HCa Configuration**  
(double hooks, load on aux. hook)

Configuration	Boom Combination	Boom Length
H	Boom	13m~64m
HCm	Boom + Extension jib (double hooks, load on main hook)	13m~61m
HCa	Boom + Extension jib (double hooks, load on aux. hook)	13m~61m

The schematics above are reference for loading only.

**Combination**

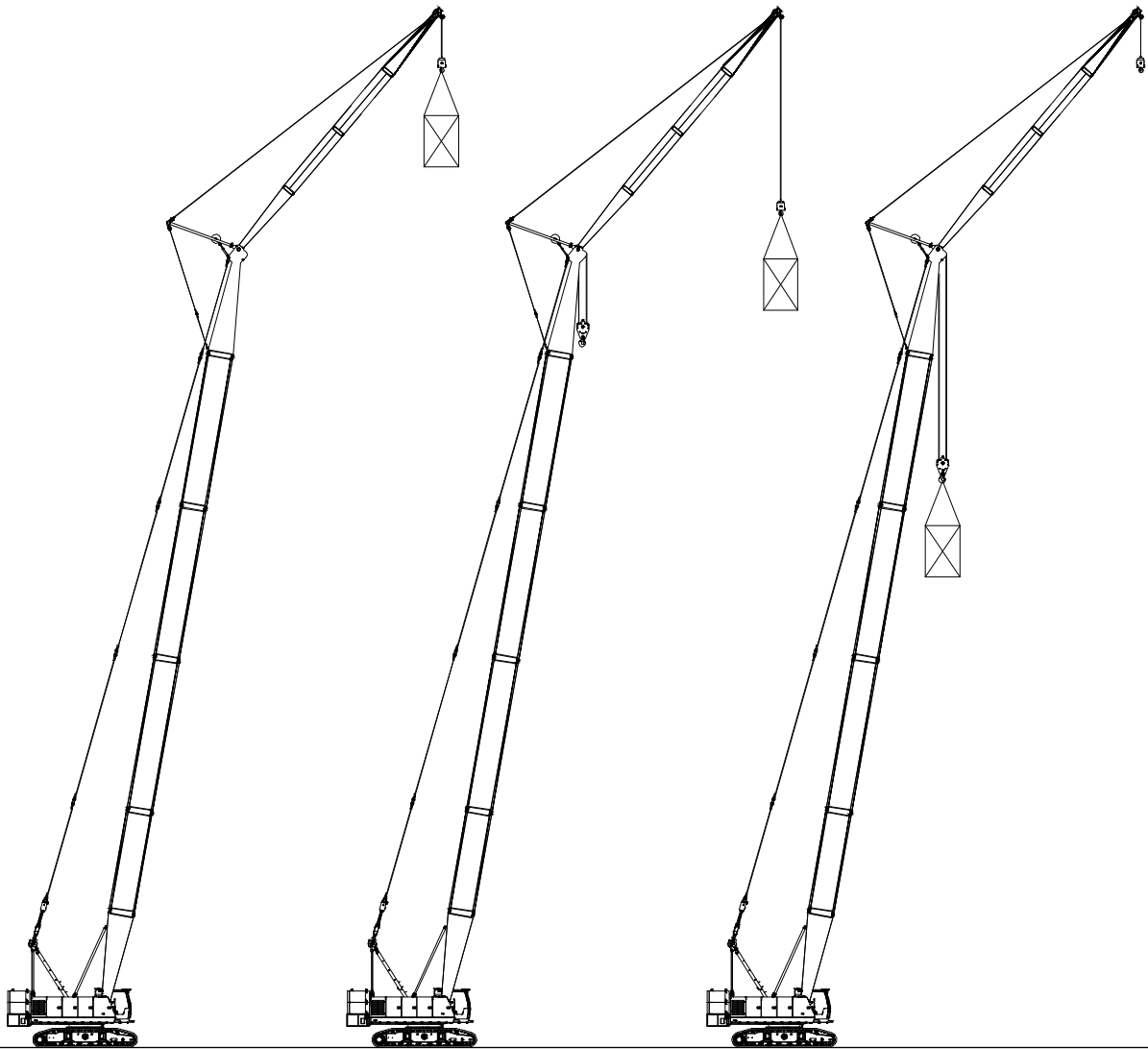

**FJ Configuration**  
(single hook)

**FJa Configuration**  
(double hooks, load on aux. hook)

**FJm Configuration**  
(double hooks, load on main hook)

Configuration	Boom Combination	Boom Length
FJ	Boom + Fixed Jib (single hook)	(31m~52m)+(9m~18m)
FJm	Boom + Fixed Jib (double hooks, load on main hook)	
FJa	Boom + Fixed Jib (double hooks, load on aux. hook)	

The schematics above are reference for loading only.

## Boom Combination in H

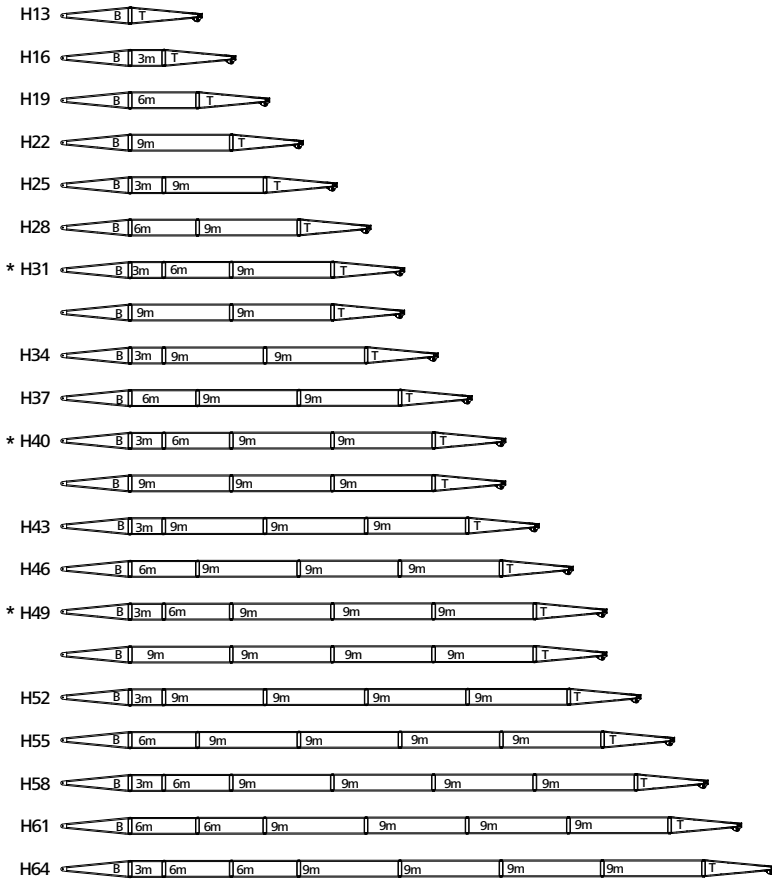

Note: The combinations with "\*" are recommended.

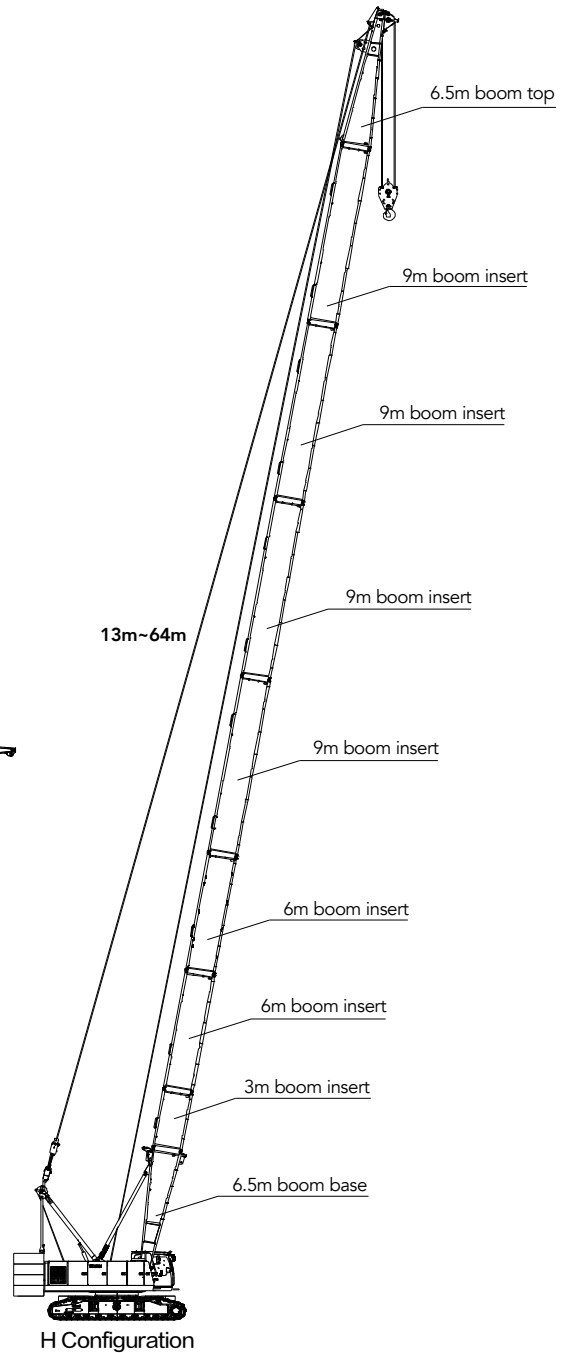
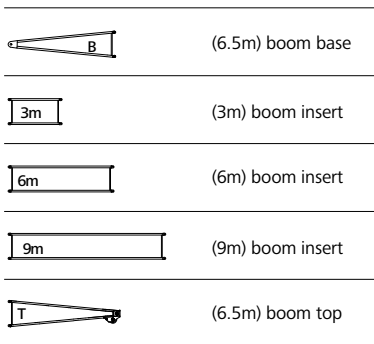

## Working Radius in H Configuration

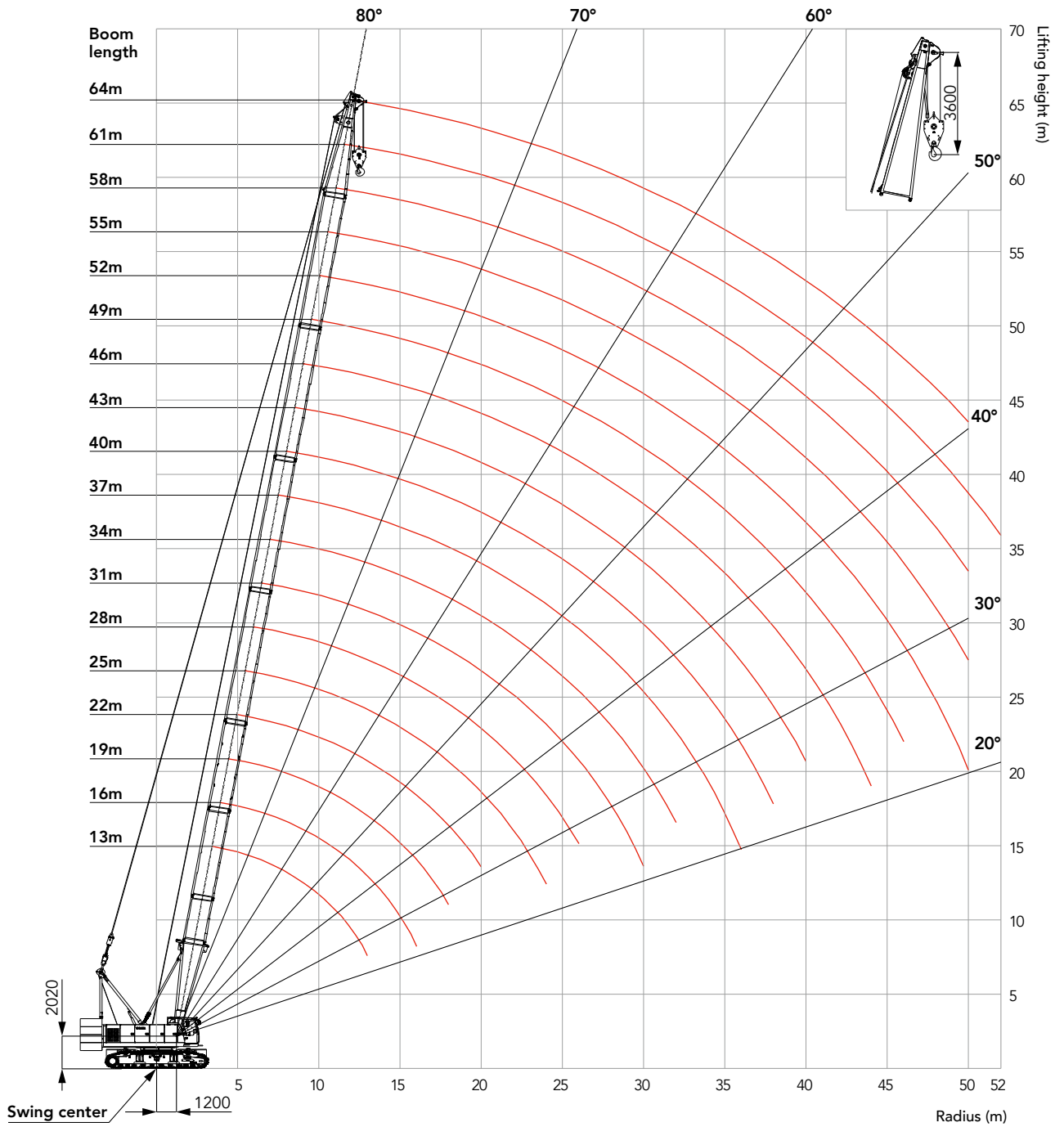

## Load Chart of H Configuration

Notes: Rated capacity of crawler crane:

- ① . The rated load in the table is calculated in accordance with GB/T 3811..
- ② . The rated capacity in the load charts is calculated when the crane is parking on firm and level ground and lifting the load slowly and steadily.
- ③ . The rated capacity values in the load charts are only valid when wind speed is lower than 9.8 m/s.
- ④ . The rated capacity in the load charts includes the weight of lifting hook, etc.; therefore, the actual rated capacity is the value after deducting the weight of lifting tools (such as lifting hook), from the rated load in the load charts.
- ⑤ . The crawlers must be extended during lifting.
- ⑥ . The values in the load charts are valid for 360° slewing.
- ⑦ . Values shaded in dark gray are determined by strength.
- ⑧ . See Operation Manual for load charts of HCm and HCa configurations.

Load chart - H (Rear counterweight 33.5t, Carbody counterweight 11t) 1/2

R(m)	BL(m)	13	16	19	22	25	28	31	34	37	BL(m)	R(m)
3.8		100										3.8
4		95										4
4.5		90	88	86								4.5
5		85	82.5	82	81							5
5.5		74.5	74	73.5	72	68.5						5.5
6		68	67.5	67	65	62	60.5	58.5				6
6.5		62	61.5	61	58.5	56.5	55.2	53.5	51.8			6.5
7		56.5	56.2	55.8	54	52.3	50.7	49.2	47.7	46.4		7
7.5		51	50.7	50.6	49.8	48.2	46.9	45.6	44.3	43.1		7.5
8		46.5	46.2	46.1	45.9	44.8	43.6	42.4	41.2	40.2		8
9		39.4	39.2	39	38.9	38.7	38.1	37.2	36.2	35.4		9
10		34.2	33.9	33.8	33.7	33.5	33.3	33.1	32.2	31.5		10
11		30.2	29.9	29.8	29.7	29.4	29.3	29.2	29	28.4		11
12		26.9	26.7	26.6	26.5	26.2	26.1	26	25.8	25.7		12
13		24.3	24.1	24	23.8	23.6	23.5	23.4	23.2	23.1		13
14			21.9	21.8	21.7	21.4	21.3	21.2	21	20.9		14
15			20	19.9	19.8	19.6	19.5	19.4	19.2	19.1		15
16				18.4	18.3	18	17.9	17.8	17.6	17.5		16
18				15.8	15.7	15.5	15.4	15.3	15	14.9		18
20					13.7	13.5	13.4	13.3	13.1	13		20
22						11.9	11.8	11.7	11.5	11.4		22
24						10.6	10.5	10.4	10.2	10.1		24
26							9.5	9.4	9.1	9		26
28								8.5	8.2	8.1		28
30									7.4	7.3		30
32									6.8	6.7		32
34										6.1		34
36												36
38												38
40												40
42												42
44												44
46												46
48												48
50												50
52												52
54												54

Note: Gray shaded values are determined by strength, and others by stability.

Unit: t

## Load Chart of H Configuration

Load chart - H (Rear counterweight 33.5t, Carbody counterweight 11t) 2/2										
R(m) \ BL(m)	40	43	46	49	52	55	58	61	64	BL(m) \ R(m)
3.8										3.8
4										4
4.5										4.5
5										5
5.5										5.5
6										6
6.5										6.5
7										7
7.5	40.6									7.5
8	39.2	35.3								8
9	34.5	33.6	30.2	26.8						9
10	30.8	30	29.2	26	23	20.5				10
11	27.8	27	26.5	25.5	22.2	19.5	17.8	15.5		11
12	25.2	24.6	24.1	23.6	21.5	19.2	17.2	15.2		12
13	22.9	22.5	22	21.6	21	18.9	16.8	15	13.2	13
14	20.8	20.5	20.3	19.9	19.3	18.3	16.2	14.5	12.6	14
15	18.9	18.7	18.6	18.4	17.9	17.5	15.7	14	12.2	15
16	17.4	17.1	17	16.9	16.6	16.2	15.1	13.5	11.6	16
18	14.8	14.6	14.5	14.4	14.2	14.1	13.7	12.6	10.8	18
20	12.9	12.6	12.5	12.4	12.2	12.1	11.9	11.7	10	20
22	11.3	11	11	10.8	10.6	10.5	10.3	10.2	9.3	22
24	10	9.8	9.7	9.6	9.3	9.2	9	8.9	8.2	24
26	8.9	8.7	8.6	8.5	8.2	8.1	7.9	7.8	7	26
28	8	7.8	7.7	7.6	7.3	7.2	7	6.9	6.7	28
30	7.2	7	6.9	6.8	6.5	6.5	6.2	6.1	5.9	30
32	6.6	6.3	6.2	6.1	5.9	5.8	5.5	5.4	5.2	32
34	6	5.7	5.6	5.5	5.3	5.2	4.9	4.8	4.6	34
36	5.4	5.2	5.1	5	4.8	4.7	4.4	4.3	4.1	36
38	5	4.7	4.6	4.5	4.3	4.2	3.9	3.9	3.6	38
40		4.3	4.2	4.1	3.9	3.8	3.5	3.4	3.2	40
42			3.8	3.7	3.5	3.4	3.2	3.1	2.8	42
44				3.4	3.2	3.1	2.8	2.7	2.5	44
46				3.1	2.8	2.8	2.5	2.4	2.2	46
48					2.6	2.5	2.2	2.1	1.9	48
50						2.2	2	1.9	1.6	50
52							1.7	1.6	1.4	52
54							1.5	1.4	1.2	54

Note: Gray shaded values are determined by strength, and others by stability.

## Boom Combination in FJ

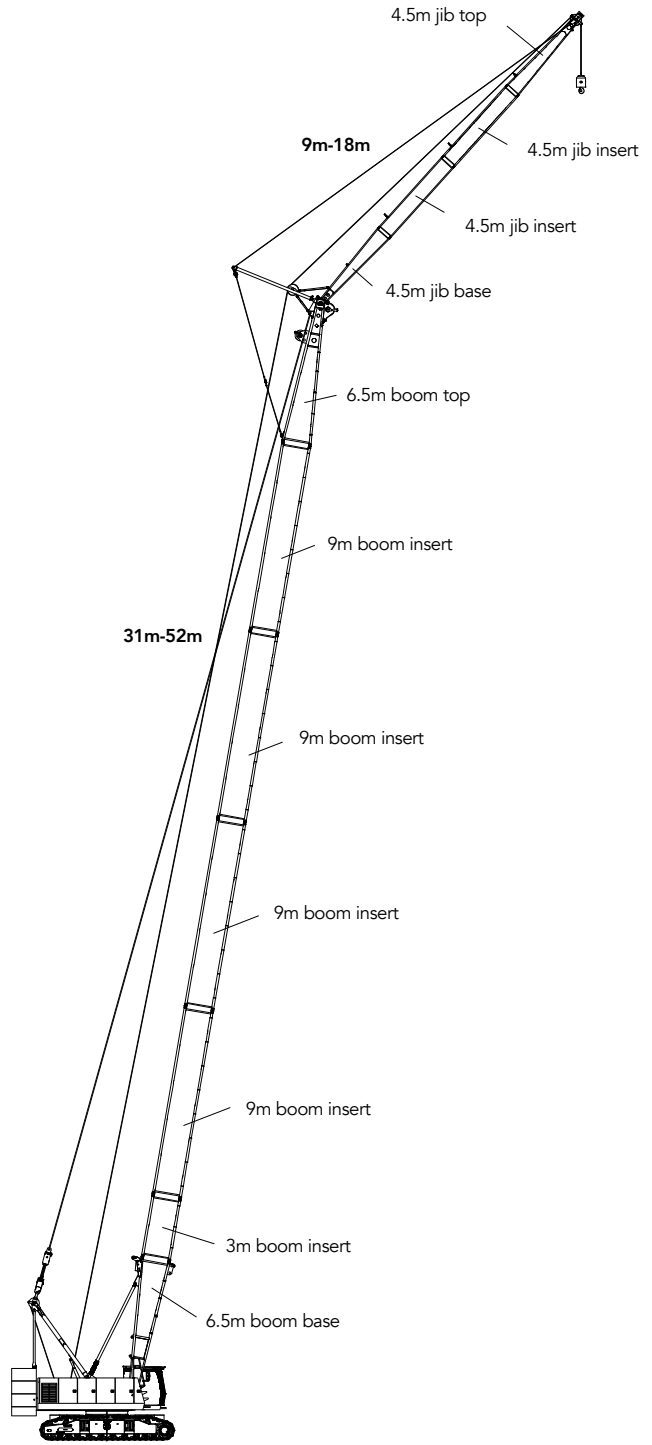
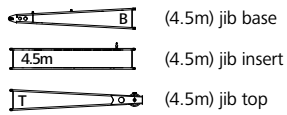
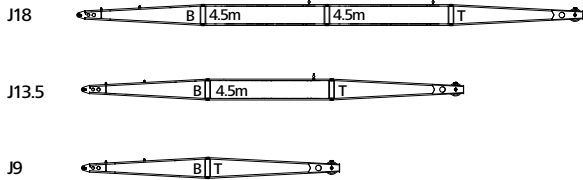

FJ Configuration



## Working Radius in FJ Configuration

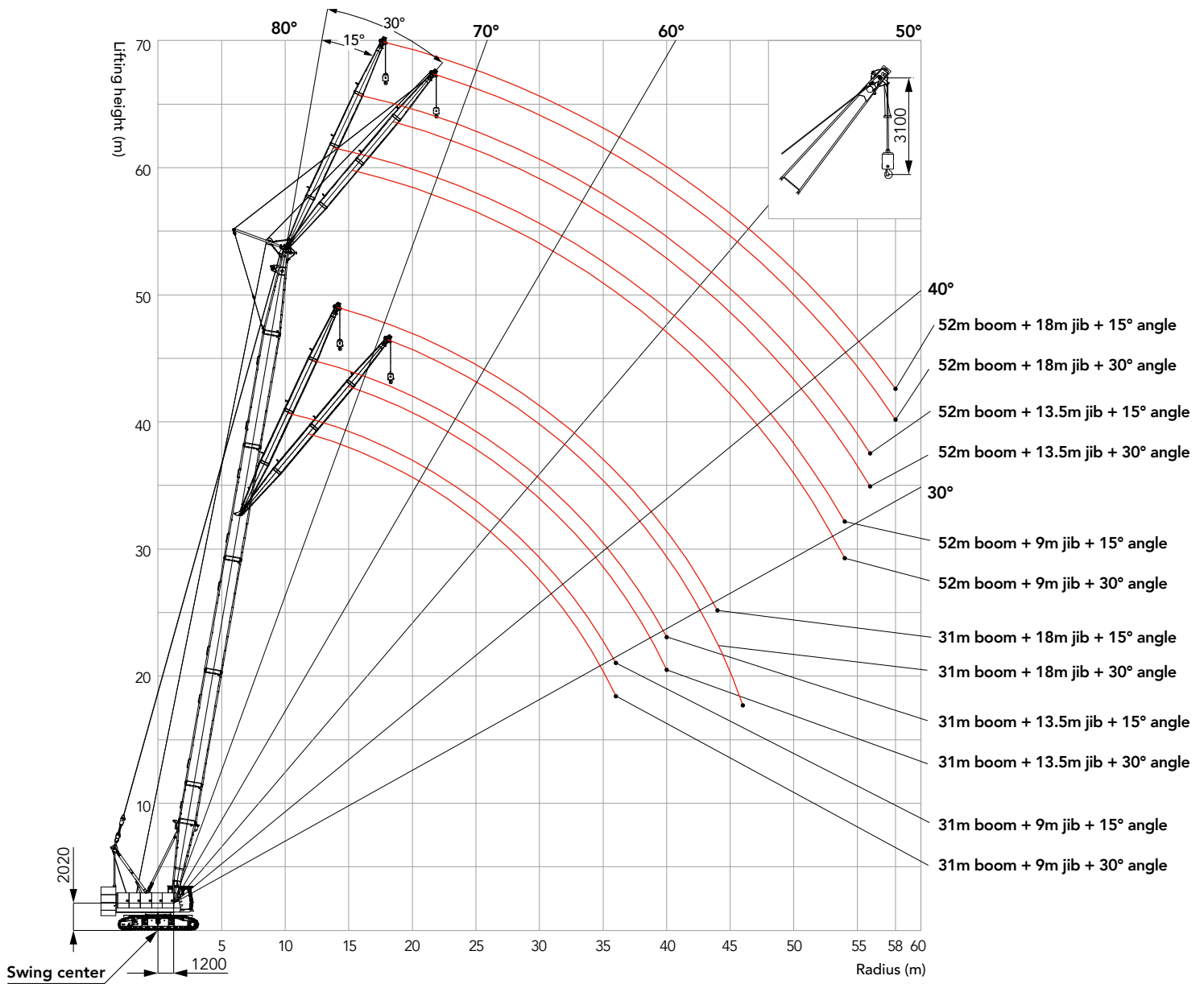

## Load Chart of FJ Configuration

Notes: Rated capacity of crawler crane:

- ① . The rated load in the table is calculated in accordance with GB/T 3811.
- ② . The rated capacity in the load charts is calculated when the crane is parking on firm and level ground and lifting the load slowly and steadily.
- ③ . The rated capacity values in the load charts are only valid when wind speed is lower than 9.8 m/s.
- ④ . The rated capacity in the load charts includes the weight of lifting hook, etc.; therefore, the actual rated capacity is the value after deducting the weight of lifting tools (such as lifting hook), from the rated load in the load charts.
- ⑤ . The crawlers must be extended during lifting.
- ⑥ . The values in the load charts are valid for 360° slewing.
- ⑦ . See Operation Manual for load charts of FJm and FJa configurations.

FJ Configuration 1/3											
Angle boom to jib 30°, Rear counterweight 33.5t, Carbody counterweight 11t, Jib 9m											
R(m)	BL(m)	31	34	37	40	43	46	49	52	BL(m)	R(m)
12		11									12
13		11	11	11							13
14		11	11	11	11	11					14
15		11	11	11	11	11	11	11			15
16		11	11	11	11	11	11	11	11		16
18		11	11	11	11	11	11	11	11		18
20		11	11	11	11	11	11	11	11		20
22		11	11	11	11	11	11	11	11		22
24		10.7	10.5	10.5	10.4	10.2	10.1	10	9.8		24
26		9.6	9.4	9.3	9.2	9.1	9	8.9	8.7		26
28		8.7	8.5	8.4	8.3	8.1	8	7.9	7.7		28
30		7.9	7.7	7.6	7.5	7.3	7.2	7.1	6.9		30
32		7.2	7	6.9	6.8	6.6	6.5	6.4	6.2		32
34		6.5	6.3	6.3	6.2	6	5.9	5.8	5.6		34
36		6	5.8	5.7	5.6	5.4	5.3	5.2	5		36
38			5.3	5.2	5.1	4.9	4.8	4.7	4.5		38
40				4.8	4.7	4.5	4.4	4.3	4.1		40
42				4.4	4.3	4.1	4	3.9	3.7		42
44					3.9	3.7	3.6	3.5	3.3		44
46						3.4	3.3	3.2	3		46
48							3	2.9	2.7		48
50							2.7	2.6	2.4		50
52								2.4	2.2		52
54									1.9		54

Note: The values shaded in dark gray are determined by single line pull or boom strength.

Unit: t

## Load Chart of FJ Configuration

FJ Configuration 2/3									
Angle boom to jib 30°, Rear counterweight 33.5t, Carbody counterweight 11t, Jib 13.5m									
R(m) \ BL(m)	31	34	37	40	43	46	49	52	BL(m) \ R(m)
15	10.9								15
16	10.5	10.7	10.9	11					16
18	10	10.1	10.3	10.5	10.6	10.7	10.6	9.4	18
20	9.4	9.6	9.8	10	10.1	10.3	9.8	9.2	20
22	9	9.2	9.4	9.6	9.7	9.9	9.6	8.9	22
24	8.6	8.8	9	9.2	9.3	9.5	9.4	8.7	24
26	8.2	8.5	8.6	8.8	9	9.2	9.1	8	26
28	7.9	8.1	8.3	8.5	8.3	8.2	8.2	7.8	28
30	7.7	7.8	7.7	7.7	7.5	7.4	7.3	7.1	30
32	7.3	7.1	7	6.9	6.8	6.7	6.6	6.4	32
34	6.7	6.5	6.4	6.3	6.1	6	6	5.8	34
36	6.1	5.9	5.8	5.7	5.6	5.5	5.4	5.2	36
38	5.6	5.4	5.3	5.2	5.1	5	4.9	4.7	38
40	5.1	5	4.9	4.8	4.6	4.5	4.4	4.3	40
42		4.6	4.5	4.4	4.2	4.1	4	3.8	42
44		4.2	4.1	4	3.8	3.8	3.7	3.5	44
46			3.8	3.7	3.5	3.4	3.3	3.1	46
48				3.4	3.2	3.1	3	2.8	48
50					2.9	2.8	2.7	2.5	50
52					2.6	2.6	2.5	2.3	52
54						2.3	2.2	2	54
56							2	1.8	56
58								1.6	58

Note: The values shaded in dark gray are determined by single line pull or boom strength.

## Load Chart of FJ Configuration

FJ Configuration 3/3											
Angle boom to jib 30°, Rear counterweight 33.5t, Carbody counterweight 11t, Jib 18m											
R(m)	BL(m)	31	34	37	40	43	46	49	52	BL(m)	R(m)
18		7.8	7.9								18
20		7.4	7.5	7.6	7.7	7.8	7.8				20
22		7	7.1	7.2	7.4	7.5	7.6	7.5	7.5		22
24		6.6	6.8	6.9	7	7.2	7.3	7.4	7		24
26		6.4	6.5	6.6	6.8	6.9	7	7.1	6.8		26
28		6.1	6.2	6.4	6.5	6.6	6.7	6.8	6.7		28
30		5.8	6	6.1	6.3	6.4	6.5	6.6	6.5		30
32		5.6	5.8	5.9	6	6.2	6.3	6.4	6.3		32
34		5.4	5.6	5.7	5.8	6	6.1	6.1	6		34
36		5.3	5.4	5.5	5.7	5.7	5.6	5.5	5.3		36
38		5.1	5.2	5.4	5.3	5.2	5.1	5	4.8		38
40		5	5	5	4.9	4.7	4.6	4.5	4.4		40
42		4.8	4.6	4.6	4.5	4.3	4.2	4.1	4		42
44		4.4	4.3	4.2	4.1	3.9	3.8	3.8	3.6		44
46		4.1	3.9	3.8	3.8	3.6	3.5	3.4	3.2		46
48			3.6	3.5	3.4	3.3	3.2	3.1	2.9		48
50				3.2	3.1	3	2.9	2.8	2.6		50
52					2.9	2.7	2.6	2.5	2.4		52
54					2.6	2.4	2.4	2.3	2.1		54
56						2.2	2.1	2.1	1.9		56
58							1.9	1.8	1.7		58
60								1.6	1.4		60
62									1.2		62

Note: The values shaded in dark gray are determined by single line pull or boom strength.

Unit: t

## Load Chart of FJ Configuration

FJ Configuration 1/3											
Angle boom to jib 15°, Rear counterweight 33.5t, Carbody counterweight 11t, Jib 9m											
R(m)	BL(m)	31	34	37	40	43	46	49	52	BL(m)	R(m)
10		11									10
11		11	11	11							11
12		11	11	11	11	11					12
13		11	11	11	11	11	11	11			13
14		11	11	11	11	11	11	11	11		14
15		11	11	11	11	11	11	11	11		15
16		11	11	11	11	11	11	11	11		16
18		11	11	11	11	11	11	11	11		18
20		11	11	11	11	11	11	11	11		20
22		11	11	11	11	11	11	11	10.9		22
24		10.6	10.4	10.3	10.2	10	9.9	9.8	9.6		24
26		9.5	9.3	9.2	9.1	8.9	8.8	8.7	8.5		26
28		8.6	8.4	8.3	8.2	7.9	7.8	7.7	7.5		28
30		7.8	7.6	7.5	7.4	7.1	7.1	6.9	6.7		30
32		7.1	6.9	6.8	6.7	6.5	6.4	6.3	6		32
34		6.5	6.3	6.2	6.1	5.9	5.8	5.6	5.4		34
36		5.9	5.7	5.6	5.5	5.3	5.2	5.1	4.9		36
38			5.3	5.2	5.1	4.8	4.7	4.6	4.4		38
40				4.7	4.6	4.4	4.3	4.2	4		40
42				4.3	4.2	4	3.9	3.8	3.6		42
44					3.9	3.7	3.6	3.5	3.3		44
46						3.4	3.3	3.2	2.9		46
48							3	2.9	2.6		48
50								2.6	2.4		50
52								2.3	2.1		52
54									1.9		54

Note: The values shaded in dark gray are determined by single line pull or boom strength.

## Load Chart of FJ Configuration

FJ Configuration 2/3											
Angle boom to jib 15°, Rear counterweight 33.5t, Carbody counterweight 11t, Jib 13.5m											
R(m)	BL(m)	31	34	37	40	43	46	49	52	BL(m)	R(m)
12		11									12
13		11	11	11	11						13
14		11	11	11	11	11	11				14
15		11	11	11	11	11	11	11	10.4		15
16		11	11	11	11	11	11	11	10.3		16
18		11	11	11	11	11	11	10.7	9.5		18
20		11	11	11	11	11	11	9.9	9.2		20
22		11	11	11	11	11	10.3	9.6	8.9		22
24		10.7	10.5	10.4	10.3	10.1	10	9.4	8.2		24
26		9.6	9.4	9.3	9.2	9	8.9	8.8	8		26
28		8.6	8.5	8.4	8.2	8.1	8	7.9	7.7		28
30		7.8	7.7	7.6	7.4	7.2	7.2	7	6.8		30
32		7.2	7	6.9	6.7	6.5	6.5	6.3	6.1		32
34		6.5	6.3	6.2	6.1	5.9	5.8	5.7	5.5		34
36		6	5.8	5.7	5.6	5.4	5.3	5.2	5		36
38		5.5	5.3	5.2	5.1	4.9	4.8	4.7	4.5		38
40		5.1	4.9	4.8	4.7	4.5	4.4	4.3	4.1		40
42			4.5	4.4	4.3	4.1	4	3.9	3.7		42
44				4.1	3.9	3.7	3.6	3.5	3.3		44
46				3.7	3.6	3.4	3.3	3.2	3		46
48					3.3	3.1	3	2.9	2.7		48
50						2.8	2.8	2.6	2.4		50
52							2.5	2.4	2.2		52
54							2.3	2.2	2		54
56								1.9	1.7		56

Note: The values shaded in dark gray are determined by single line pull or boom strength.

Unit: t

## Load Chart of FJ Configuration

FJ Configuration 3/3										
Angle boom to jib 15°, Rear counterweight 33.5t, Carbody counterweight 11t, Jib 18m										
R(m) \ BL(m)	31	34	37	40	43	46	49	52	BL(m) \ R(m)	
14	11	11								14
15	11	11	11	11						15
16	11	11	11	11	10.3	9.7				16
18	11	11	10.8	10.2	10.1	9.4	8.8	8.1		18
20	10.3	10.2	10.1	9.9	9.3	9.2	8.5	7.9		20
22	10.1	9.9	9.8	9.7	9	8.4	8.3	7.6		22
24	9.3	9.7	9.1	9	8.8	8.2	7.6	7.4		24
26	9.1	9	8.9	8.8	8.6	8	7.4	6.7		26
28	8.4	8.5	8.4	8.3	8	7.9	7.2	6.6		28
30	7.9	7.7	7.6	7.5	7.3	7.2	7.1	6.4		30
32	7.2	7	6.9	6.8	6.6	6.5	6.4	6.2		32
34	6.6	6.4	6.3	6.2	6	5.9	5.8	5.6		34
36	6	5.8	5.7	5.6	5.4	5.3	5.2	5.1		36
38	5.5	5.3	5.3	5.1	5	4.9	4.8	4.6		38
40	5.1	4.9	4.8	4.7	4.5	4.4	4.3	4.1		40
42	4.7	4.5	4.4	4.3	4.1	4	3.9	3.7		42
44	4.4	4.2	4.1	4	3.8	3.7	3.6	3.4		44
46		3.8	3.8	3.6	3.4	3.4	3.2	3		46
48		3.5	3.5	3.3	3.2	3.1	2.9	2.7		48
50			3.2	3.1	2.9	2.8	2.7	2.5		50
52				2.8	2.6	2.5	2.4	2.2		52
54					2.4	2.3	2.2	2		54
56					2.2	2.1	2	1.8		56
58						1.9	1.8	1.6		58
60							1.6	1.4		60
62								1.2		62

Note: The values shaded in dark gray are determined by single line pull or boom strength.



## Zhejiang Sany Equipment Co.,LTD

SANY Crawler Crane Industrial Park, No. 2188 Daishan Road, Wuxing District, Huzhou City,  
Zhejiang Province, P. R. China Zip 313028  
Consulting [sanycrane@sanygroup.com](mailto:sanycrane@sanygroup.com) (Crane BU) / [crd@sany.com.cn](mailto:crd@sany.com.cn) (IHQ)  
After-sales Service 0086-400 6098 318

**Reminder:**

Any change in the technical parameters and configuration due to product modification or upgrade may occur without prior notice.  
The machine in the picture may include additional equipment. This brochure is for reference only, and goods in kind shall prevail.  
Copyright at SANY. No part of this brochure may be copied or used for any purpose without written approval from SANY.

© Edited in October 2022

