

SPECIFICATION



 250t

 75m

 111m

SAC2500E

SANY ALL TERRAIN CRANE

QUALITY CHANGES THE WORLD

www.sanyglobal.com

It is one of the core business units in SANY Group, specializing in the development and manufacturing of high-end wheel cranes, crawler cranes and tower cranes, including the complete range of wheel cranes from 8 to 2400t, crawler cranes from 25 to 4500t and tower cranes from 6 to 185t.

三一集团旗下核心事业部，从事高端轮式起重机、履带起重机、塔式起重机系列产品的研发制造。覆盖8-2400吨全吨位轮式起重机，25-4500吨全吨位履带起重机，6-185吨塔式起重机。



SANY CRANE



SAC2500E

SANY ALL TERRAIN CRANE
250T LIFTING CAPACITY

SAC2500E is an all-terrain crane with 250t lifting capacity, 7 section 75m boom, and features dual engine power system, wireless remote control of all motions, standard anti-electromagnetic interference module, and the brand-new iCab, with driving and operation comfort fully upgraded.

一款最大起重量250吨、7节臂、全伸主臂75米的全地面起重机，配备双发动力系统。整车动作可无线遥控，标配抗电磁干扰模块，配备全新两室——iCab，驾驶、操作舒适度全面升级。



75m boom

Boom full extension 75m

75m主臂

主臂全伸最长75m

Wireless remote control

Wireless remote control available for all actions

无线遥控

整车动作全部实现无线遥控



Anti-electromagnetic interference

An anti-electromagnetic interference module adopted, enabling well functioning under strong electric and magnetic conditions (excluding wireless operations)

抗电磁干扰

通过抗电磁干扰模块可以实现在强电强磁下的正常工作（不含无线操作）

All new iCab design

Ergonomic concept of safety and comfort

全新两室

操作安全、舒适、人机工程全面升级



i-Cab -Driver's cab

新两室 - 驾驶室

Multi-function seat with air suspension, making driving more comfortable.

Double seats and foldable berth for the co-driver.

12.1-inch automotive grade dash screen integrated with back-up image and multi-media.

Electric rearview mirror with electric heating, ensuring good field of view in foul weather.

Adjustable high-brightness LED headlamps/fog lamps, providing clear vision at night.

Full-automatic HVAC, able to automatically adjust indoor temperature as demanded.

驾驶位配备气浮多功能座椅, 驾驶更舒适。

副驾驶位设置双座椅可折叠式卧铺。

12.1英寸车规级中控屏, 集成倒车影像、影音娱乐功能。

电动、电加热后视镜, 不惧怕恶劣冰雪天气。

高亮度可调节 LED 大灯 / 雾灯, 夜间视野清晰。

全自动冷暖空调, 自动根据需求调整室内温度。

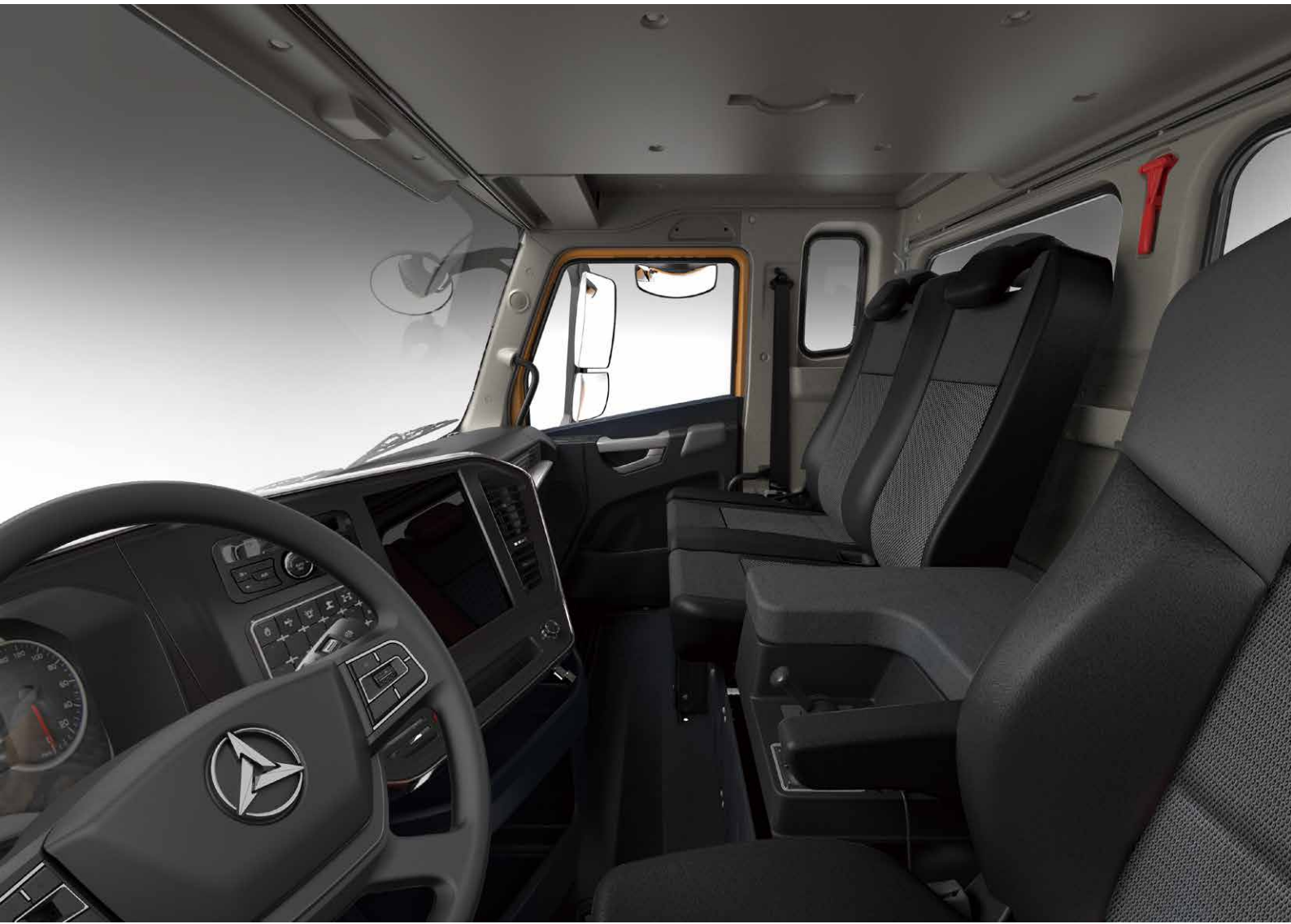



i-Cab - Operator's cab

新两室 - 操纵室

Seat widened by 480mm, and leg room increased by 30%.

Cab tiltable by 0-20°, relieving cervical fatigue during large-angle and long-boom operations.

Electric adjustable seat with maximum inclination of 140°, allowing the operator to lie flat and rest after work.

Electric seat linked with armrest, enabling multi-dimensional adjustment for enhanced comfort.

Electronic control joysticks, making operation easier.

Ergonomically positioned control panels, easy to reach and operate.

70° openable front window convenient for ventilation and escape, in compliance with CE standards.

Curved-track sliding door, more convenient for getting on/off the cab and opening/closing the door.

Full-automatic HVAC, automatically adjusting indoor temperature as demanded.

Double 10.1-inch display screens.

座椅加宽至 480mm，腿部活动空间较上一代增加 30%。

操纵室可实现 0-20° 上仰变位，大角度、长臂段作业时可减缓颈椎疲劳。

电动座椅后背，最大后仰 140°，操作手可平躺休息。

电动座椅 + 扶手箱联动，多维度调节，更加舒适。

电控操纵手柄，操作毫不费力。

配备功能面板及左右扶手箱动作按键面板，触手可及，方便操控。

70° 可开启式前窗，方便通风及逃生，操作室满足 CE 要求。

变轨滑移门，上下车、开关门更方便。

全自动冷暖空调，自动根据需求调整室内温度。

10.1 寸双屏显示。



Anti-electromagnetic Interference

抗电磁干扰

Anti-electromagnetic interference module, allowing the crane to work normally in strong electric field or strong magnetic field ($\leq 20\text{V/m}$ and $>500\text{m}$ away from interference source), including cluster construction of high-power equipment, and the vicinity of multiple interference sources including high-voltage lines, broadcasting base stations, power plants, aluminum plants, radar stations, military bases or mobile communication stations.

配备抗电磁干扰模块,实现在场强不大于 20V/m 、距干扰源 500 米范围外的强电场、强磁场,如大功率设备集群化施工,紧邻高压线、广播基站、电厂、铝厂、雷达基站、军事基地或移动设备等通信基站附近多个干扰源的环境中正常工作。



Wireless Remote Control System

无线遥控系统

Main functions

Outrigger control - single-piece / single-side outrigger beam and jack telescoping in/out, and one-button leveling.

Crane operation boom telescoping, luffing, slewing, hoisting.

Auxiliary action control - counterweight lifting/lowering, jib pushing/pulling, side step extension/retraction, cab tilting, etc.

主要功能

支腿控制——单个和单边支腿水平伸缩、垂直起落,并支持一键调平。

上车作业实现伸缩臂、起落幅、回转、卷扬收放绳。

辅助动作操作——配重起落、副臂推拉、踏板伸缩、操作室变位等辅助操作。

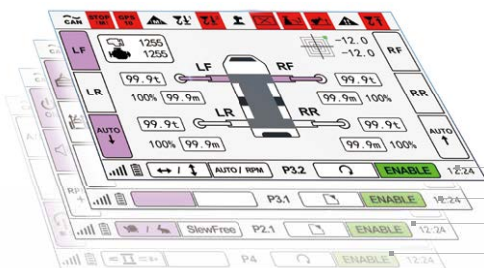

- Outrigger status 支腿界面
- Counterweight lifting/lowering, step extension/retraction 配重起落、踏板伸缩
- Main parameters 主参数展示界面
- Boom telescoping 起重臂伸缩界面

Working Condition

工况组合

T: Boom 主臂

Max. lifting capacity 最大起重量	250t
Max. boom length 最长臂	75m
Max. radius 最大幅度	70m
Max. height 最大高度	74m

TJ: Boom + fixed jib* 主臂 + 固定副臂 *

Max. lifting capacity 最大起重量	6.0t
Max. boom length 最长臂	75m+20m
Max. radius 最大幅度	82m
Max. height 最大高度	93m

TH: Boom + hydraulically adjustable jib* 主臂 + 液压变幅副臂 *

Max. lifting capacity 最大起重量	6.0t
Max. boom length 最长臂	75m+20m
Max. radius 最大幅度	82m
Max. height 最大高度	93m

TEJ: Boom + extension + fixed jib* 主臂 + 延伸臂 + 固定副臂 *

Max. lifting capacity 最大起重量	2.7t
Max. boom length 最长臂	70.1m+43m
Max. radius 最大幅度	82m
Max. height 最大高度	111m

TEH: Boom + extension + hydraulically adjustable jib* 主臂 + 延伸臂 + 液压变幅副臂 *

Max. lifting capacity 最大起重量	2.7t
Max. boom length 最长臂	70.1m+43m
Max. radius 最大幅度	82m
Max. height 最大高度	111m

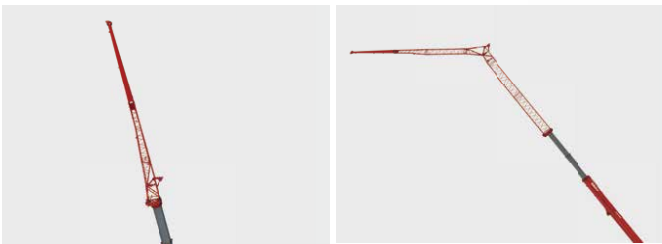

*Optional 选配

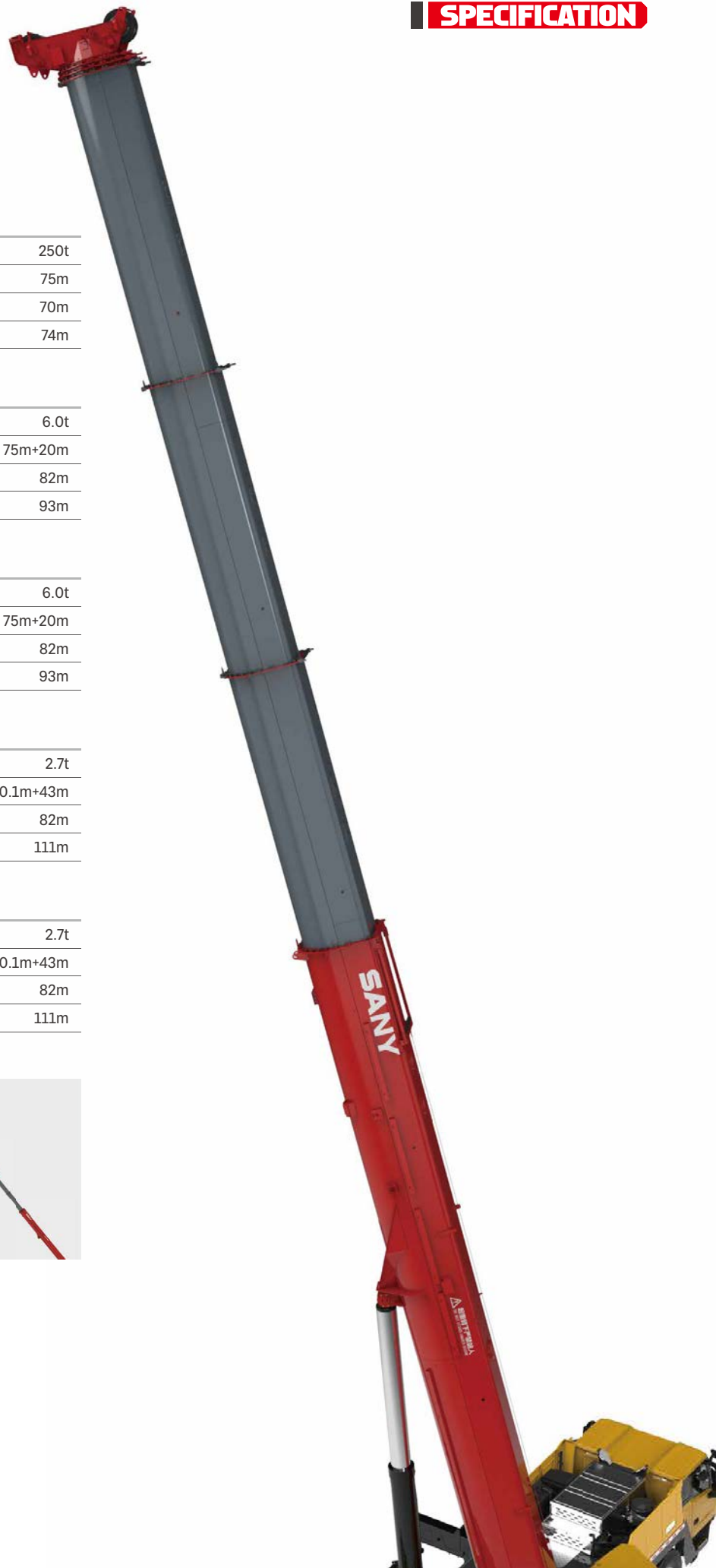

Power Train

动力系统

Chassis engine

Mercedes-Benz OM471LA off-road in-line six cylinder water-cooled diesel engine, complying with EU Stage III or EU Stage V emission standards.

Rated power: 390kW/1600rpm.

Max. torque: 2600Nm/1300rpm.

Fuel reservoir capacity: 450L.

Crane engine

Cummins B6.7 off-road in-line six cylinder water-cooled diesel engine, complying with EU Stage III or EU Stage V emission standards.

Rated power: 149kW/2200rpm (E5), 150kW/2050rpm (E3A).

Max. torque: 990N·m/1300rpm (E5), 825N·m/1100rpm (E3A).

Fuel reservoir capacity: 200L.

Transmission

ZF Traxon AMT.

12 speeds forward and 2 speeds reverse.

Braking system

Braking system consisting of Kessler disc brake, WABCO brake caliper, air chamber and ABS, more reliable and efficient. ZF transmission hydraulic retarder, allowing for effective assist braking, reducing the wear of axle brake linings and prolonging service life.

Axles and suspension

Kessler axles with high bearing capacity and reliable quality. Hydro pneumatic suspension system.

Standard 10 × 6, with axles 2, 4, 5 driven.

Steering system

Dual-circuit power steering gear, with all axles steered.

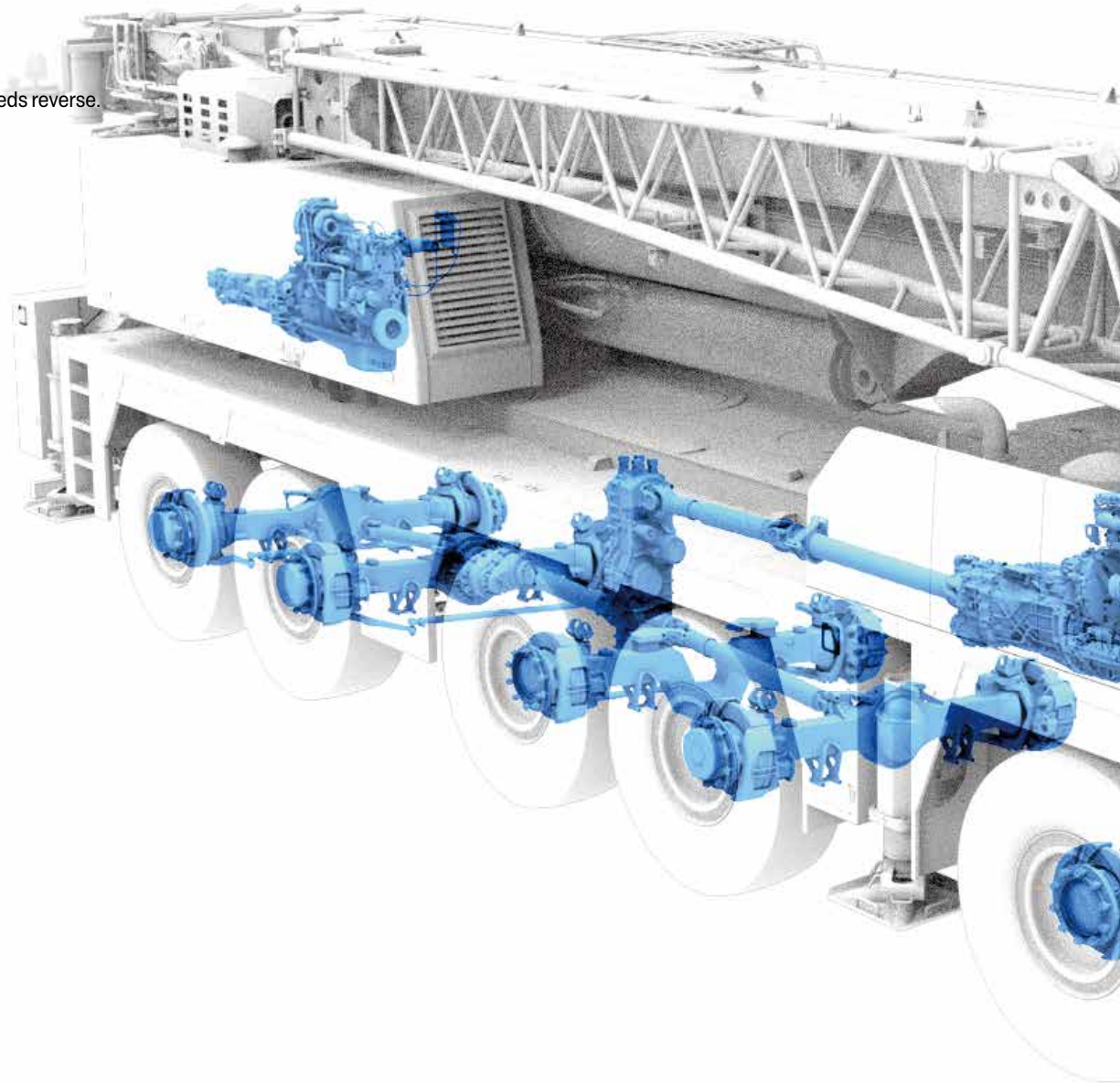

底盘发动机

奔驰OM471LA非道路直列6缸水冷柴油机，可满足欧三、欧五排放法规要求。

额定功率：390kW/1600rpm。

最大扭矩：2600N·m/1300rpm。

燃油箱容积450L。

上车发动机

康明斯B6.7直列6缸水冷柴油机，可满足欧三、欧五排放法规要求。

额定功率：149kW/2200rpm (E5)，150kW/2050rpm (E3A)

最大扭矩：990N·m/1300rpm (E5)，825N·m/1100rpm (E3A)。

燃油箱容积：200L。

变速箱

ZF Traxon手自一体变速箱。

12个前进挡和2个倒挡。

制动系统

由Kessler制动盘，WABCO制动钳，制动气室及ABS主要配件系统组成，制动性能更加可靠、高效。ZF变速箱集成液力缓速器，可有效进行辅助制动，减少车桥制动片磨损，提高制动片使用寿命。

车桥悬架

Kessler车桥，承载能力强，质量可靠。采用油气悬挂系统。

标配10×6驱动模式，2、4、5桥为驱动桥。

转向系统

双回路助力转向器，双回路转向助力系统，全轮转向。

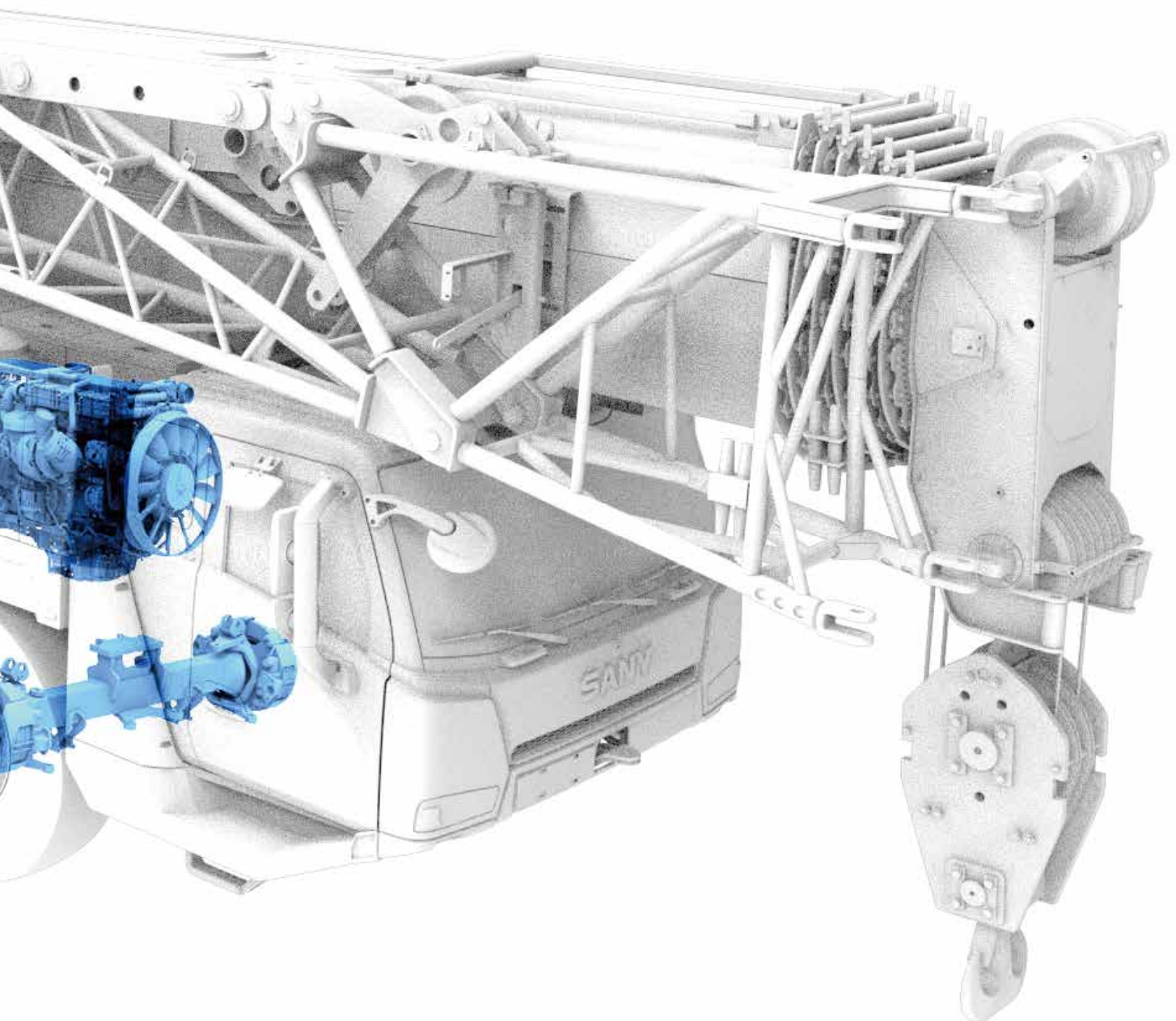

Electrical System

电气系统

Smart CAN-BUS communication system

International advanced CAN-BUS data communication network. CAN-BUS networking applied for display, instrument panel, I/O module and main sensors, allowing for high-speed data transmission, and quick response less than 20ms.

Smart fault diagnosis system

The chassis adopts safety controller functioning smart monitoring, BCM power distribution management and integrated with fault diagnosis system, enabling accurate fault location, and convenient inspection and maintenance.

Automotive grade dash screen

Integrating functions including suspension control, steering control, outrigger control and data calibration.

Precise load moment indicator

SANY independently developed high-precision LMI.

Cabling

Centralized junction box and heavy-duty connector applied for cabling of superstructure, convenient for maintenance; IP rating up to IP67, ensuring high reliability.

Winch monitoring system

Winch cameras equipped for monitoring its working condition and identifying rope disorder in time.

Integrated bus button panel input

Various operating states displayed by button indicator lights, and one-button multi-functional operation realizable by writing various operation modes.

智能总线通信系统

国际先进的分布式集成总线数据通信网络。显示器、显示仪表、I/O 模块、主要传感器等采用 CAN 总线组网, 高速信息传输、响应速度小于 20ms。

智能故障诊断系统

底盘采用安全主控制器操作装置带智能监控、BCM 配电管理, 拥有故障诊断系统, 能精准定位故障点, 方便检修。

车规级中控屏

集成悬挂、转向、支腿、数据标定等作业功能。

精准力限器系统

三一自主研发的高精度力矩限制器系统。

电缆布线

上车电缆布线采用集中式分线盒及重载接插件, 维护方便; 防护等级 IP67, 可靠性高。

卷扬监控系统

卷扬摄像头监视卷扬工作, 及时发现乱绳的情况。

集成总线按键面板输入

可通过按键指示灯显示各种工作状态, 通过写入多种操作模式实现一键多功能。



Anti-two-block switch
高度限位器



Third wrap indicator
三圈保护器



Cable reel
电缆卷筒



Cable reel inside the boom
臂内卷筒



Anemometer
风速仪

MachineLink+

ROOTCLOUD T-AMS Pro device comes as standard to realize GPS trajectory, machine status, maintenance management, alarm management, on computer or mobile MachineLink+ platform, by remote control of cranes. This telematics package greatly boosts efficiency of customer fleet management and helps provide better after-sales services.

标配树根物联终端 T-AMS Pro, 通过对起重机设备的远程控制, 在电脑或移动端 MachineLink+ 平台实现轨迹回放、设备状态、维保设备、报警管理等功能, 极大提高客户设备管理效率, 提升三一售后服务能力。

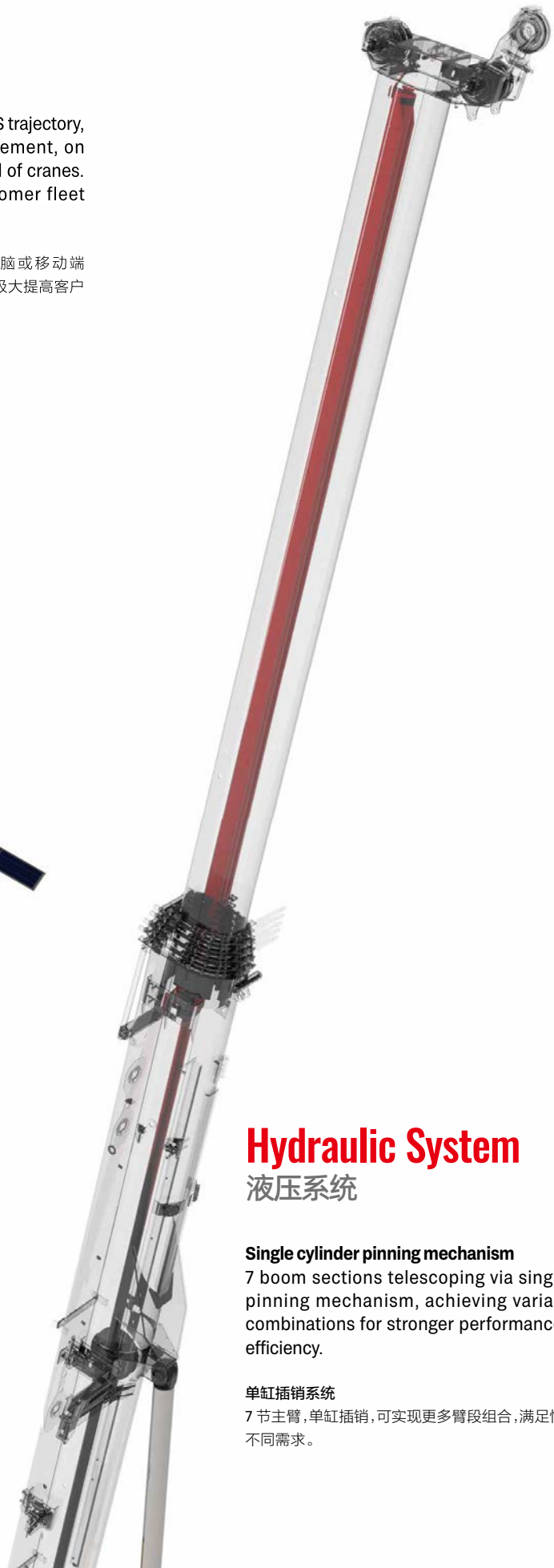
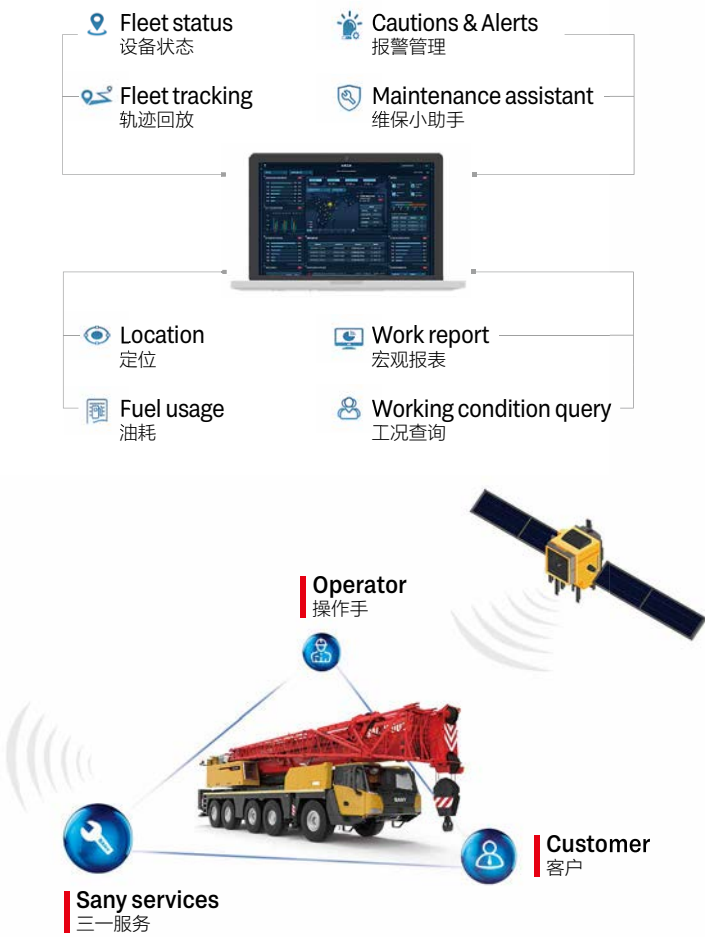

Hydraulic System 液压系统

Single cylinder pinning mechanism

7 boom sections telescoping via single cylinder pinning mechanism, achieving variable length combinations for stronger performance or higher efficiency.

单缸插销系统

7节主臂, 单缸插销, 可实现更多臂段组合, 满足性能和效率的不同需求。

Superstructure

上车

Open-type electronically controlled load-sensing system and closed-type slewing system, enabling combined operation of four actions at the same time.

Electro proportional compensated passive luffing-down system applied to control the luffing speed, making luffing more reliable and stable.

Closed-type slewing system, ensuring no pressure loss and no overflowing noise upon start/stop, and making the operation quieter and more energy-saving.

Electronically controlled load-sensing hydraulic system, electronic joystick and electronic throttle, ensuring easy operation and more accurate control and millisecond-level action response speed, with min. single-rope hoisting speed $\leq 1\text{m}/\text{min}$.

通过开式电控负载敏感系统和闭式回转系统,可同时实现四动作联动。

电比例自重落幅系统控制落幅速度,更可靠更平稳。

采用闭式回转系统,停启时无压力损失,无溢流噪声,更安静,更节能。

电控负载敏感液压系统,采用电手柄、电油门控制,轻松操作的同时,控制更精准;动作响应毫秒级速度;卷扬单绳最低速度 $\leq 1\text{m}/\text{min}$ 。

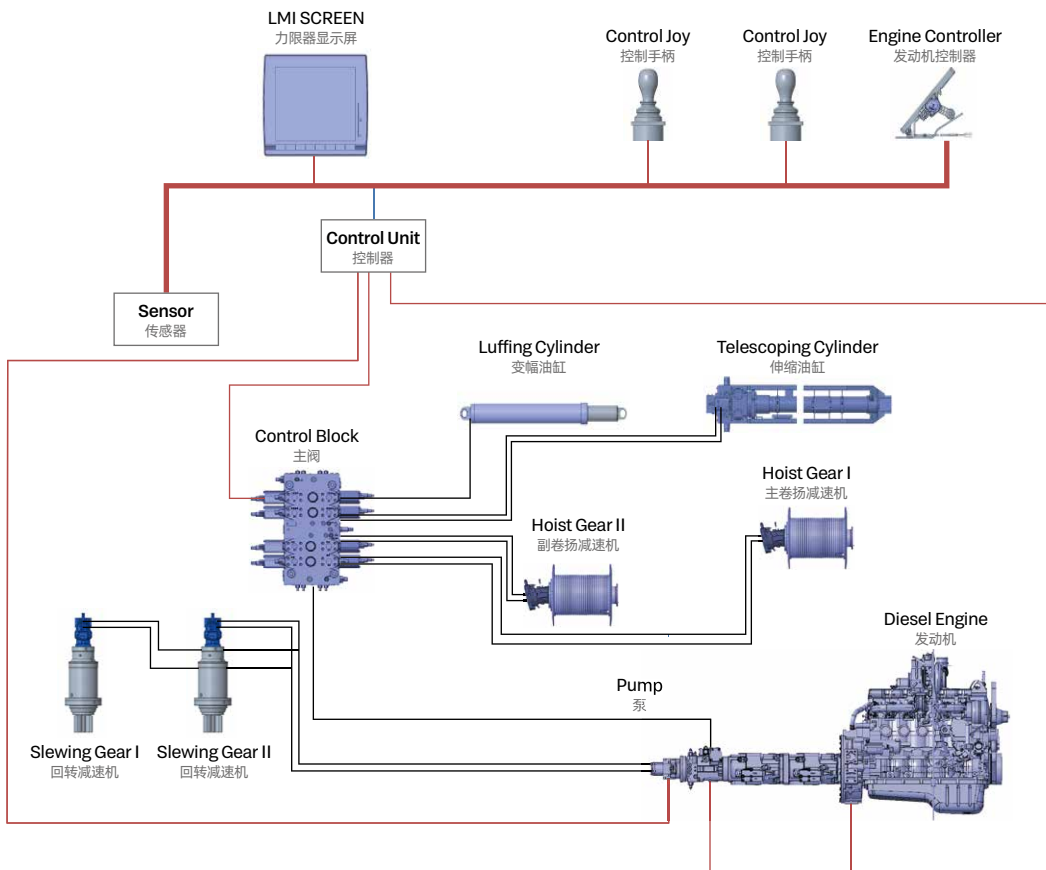

Chassis

下车

Dual circuit + emergency main steering system

Main steering system: Dual oil pump directly connected to the engine to supply oil independently to the steering gear, ensuring efficient and reliable steering.

Emergency steering system: An emergency pump installed on the transfer case, ensuring steering assistance throughout the traveling.

Electro-hydraulic assisted steering system

A Rexroth load-sensing piston pump installed to supply oil for assisted steering, which is directly connected to the engine and always in the standby mode, so that the assisted steering system can respond quickly once the assisted steering command is received.

Suspension system

A Rexroth piston pump adopted as the power source of suspension system, and suspension modes electrically controlled to realize normal driving and driving with CW on board with suspension locked; suspension to be locked when the crane is operating.

Outrigger telescoping system

Full-electric control of outrigger, realizing arbitrary telescoping and auto leveling.

双回路 + 应急主转向系统

主转向系统：双联油泵与发动机直连，独立对方向机供油，主转向高效、可靠。

应急转向系统：分动箱上配置应急泵，确保车辆行进过程中始终有转向助力。

电液辅助转向系统

辅助转向采用力士乐负载敏感柱塞泵提供油源，该油泵与发动机直连，油泵始终处于转向待机模式，一旦接到辅助转向指令，辅助转向系统能够快速响应。

悬挂系统

悬挂系统采用力士乐柱塞泵作为动力油源，操作方式采用电控，通过选择不同的悬挂模式可以实现正常行驶和锁定模式下的带载行驶；在起重机上车作业时能够对悬挂进行锁定。

支腿伸缩系统

支腿伸缩采用全电控方式，可实现支腿的无级伸缩，电控模式下可实现整车自动调平。

Overall Dimensions

整机尺寸

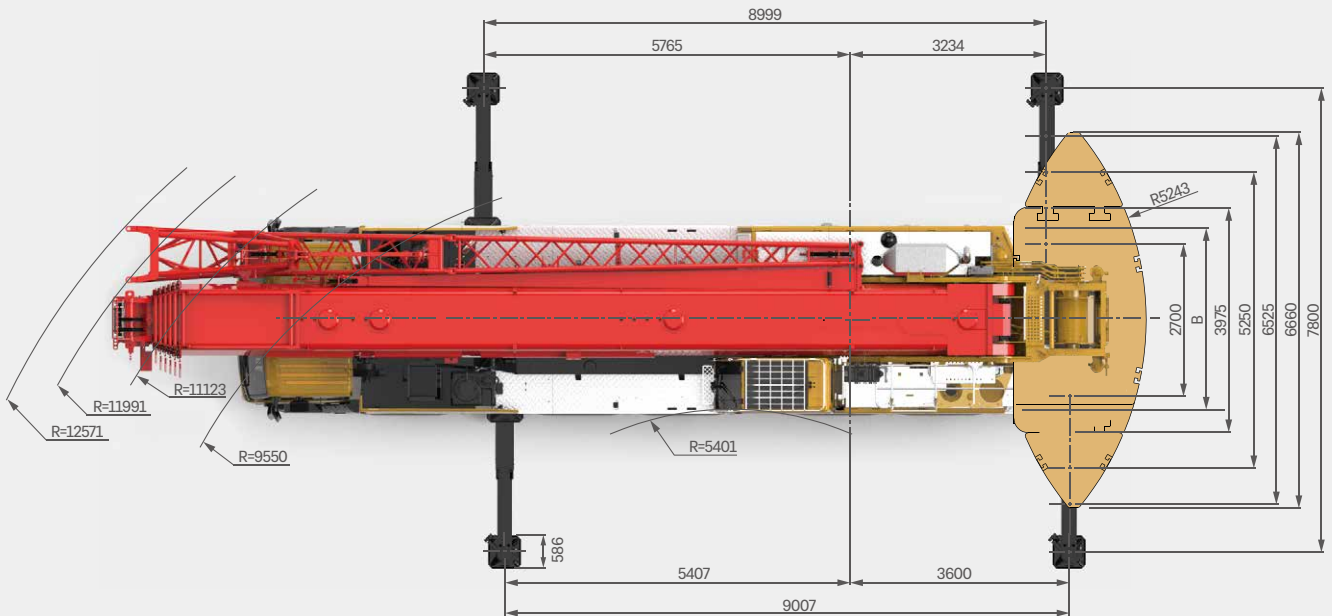
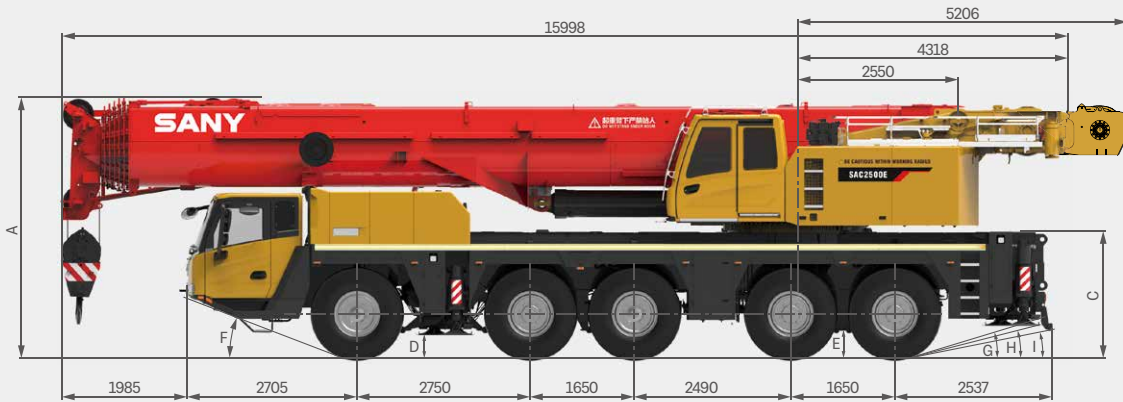

Tire size 轮胎尺寸	A	A*	B	C	D	E	F	G	H	I
		-125/+165								
Unit 单位	mm	mm	mm	mm	mm	mm	°	°	°	°
385/95 R25	3950	3825	3000	1940	293	329	18	16	12	8
445/95 R25	4000	3875	3000	1990	343	379	20	17	14	10
525/80 R25	4000	3875	3100	1990	343	379	20	17	14	10

Remark: A column is calculated when suspension is at middle level. A* column is calculated when suspension is at lowest level.
备注: A 列为悬挂处于中位, A* 列为悬挂处于最低位。







Technical Specification

整机参数 (385/95 R25)

CATEGORY 类型	ITEM 项目	UNIT 单位	VALUE 参数	
CAPACITY 额定起重量	Max. lifting capacity 最大起重量	t	250	
WEIGHT 重量参数	Gross weight 整机总质量	kg	60000	
POWER (CHASSIS) 发动机参数 (下车)	Engine model 发动机型号	-	OM471LA	
	Max. engine power 发动机最大功率	kW/rpm	390/1600	
	Max. engine torque 发动机最大输出扭矩	N·m/rpm	2600/1300	
POWER (SUPERSTRUCTURE) 发动机参数 (上车)	Engine model 发动机型号	-	B6.7(E5) / QSB7(E3A)	
	Max. engine power 发动机最大功率	kW/rpm	(149/2200) / (150/2050)	
	Max. engine torque 发动机最大输出扭矩	N·m/rpm	(990/1300) / (825/1100)	
DIMENSIONS 尺寸参数	Overall length 整机全长	mm	15998	
	Overall width 整机全宽	mm	3000	
	Overall height 整机全高	mm	3950	
TRAVEL 行驶参数	Max. travel speed 最高行驶速度	km/h	80	
	Steering radius 转弯半径	Min.steering radius 最小转弯半径	mm	9500
		Min.steering radius of boom tip 臂头最小转弯半径	mm	12571
	Wheel formula 车轮模式	-	10 × 6	
	Min.ground clearance 最小离地间隙	mm	280	
	Approach angle 接近角	°	18	
	Departure angle 离去角	°	16	
	Max.gradeability 最大爬坡度	-	60%	
	Fuel consumption per 100km 每 100 公里油耗	L	80	
MAIN PERFORMANCE 主要性能参数	Working temperature range 使用温度区间	℃	-20~+45	
	Min.rated lifting radius 最小额定幅度	m	2.5	
	Tail slewing radius 转台尾部回转半径	m	5.3	
	Boom sections (Qty.) 臂节数	-	7	
	Boom shape 臂形状	-	U shape U型	
	Max.lifting moment 最大起重力矩	Basic boom 基本臂	kN·m	6509
		Full-extension boom 全伸主臂	kN·m	2699
		Full-extension boom + jib 全伸主臂 + 副臂	kN·m	741
	Boom length 臂长	Basic boom 基本臂	m	13.9
		Full-extension boom 全伸主臂	m	75
		Full-extension boom + jib 全伸主臂 + 副臂		113.1
	Max.lifting height 最大起重高度	Basic boom 基本臂	m	14.6
		Full-extension boom 全伸主臂	m	74
		Full-extension boom + jib 全伸主臂 + 副臂	m	111
Outrigger span (Longitudinal × Transverse) 支腿跨距 (纵 × 横)	m	9 × 7.8		
Jib offset 副臂安装角度	°	0, 15, 30, 50		
AIRCONDITIONER 空调	In operator's cab 上车空调	-	Heating & Cooling 制冷、制热	
	In driver's cab 下车空调	-	Heating & Cooling 制冷、制热	

Technical Specification

整机参数

	Total						
12t	60t	10 × 6	385/95 Steel	-	-	-	-
12t	60t	10 × 6	385/95 Alu	-	-	-	-
12t	60t	10 × 6	445/95 Alu	-	-	-	-
12t	60t	10 × 6	525/80 Alu	-	-	-	-
< 16.5t	82.5t	10 × 6	445/95 Alu	32t hook	22t	-	●



Hook 吊钩

Type 型号 /t	Load 起重量 /t	Number of sheaves 滑轮数量	Rope rate 倍率	Hook weight/kg 吊钩重量
160	○ 134	7	14	1538
125	○ 107.7	5	11	1122
80	● 70.6	3	7	685
32	○ 31.2	1	3	487
12.5	● 10.5	0	1	270

● Standard 标配 ○ Optional 选配



Operations 主要动作参数

Item 项目	Max. single rope lifting speed (empty load) 单绳速度 (空载)	Rope diameter/length 钢丝绳直径 / 长度	Max. single line pull 最大单绳拉力
Main winch 主卷扬	130m/min	22mm/300m	105kN
Auxiliary winch 副卷扬	130m/min	22mm/300m	105kN
Slewing speed 回转速度	1.5r/min		
Full luffing up/down time of boom 主臂起落幅时间	55s/90s		
Full extension/retraction time of boom 主臂伸缩时间	620s/620s		
Outrigger jack 垂直支腿	Retraction 收	35s	
	Extension 放	45s	
Outrigger beam 水平支腿	Retraction 收	30s	
	Extension 放	30s	



Chassis 底盘

Tire size 轮胎	Min. speed 最小	Max. speed 最大	Max. gradeability 爬坡度
385/95 R25 (14.00 R25)	1.9km/h	80km/h	>60%
445/95 R25 (16.00 R25)	2.1km/h	80km/h	56%
525/80 R25 (20.5 R25)	2.1km/h	80km/h	56%

Travel Flexibility

通过能力

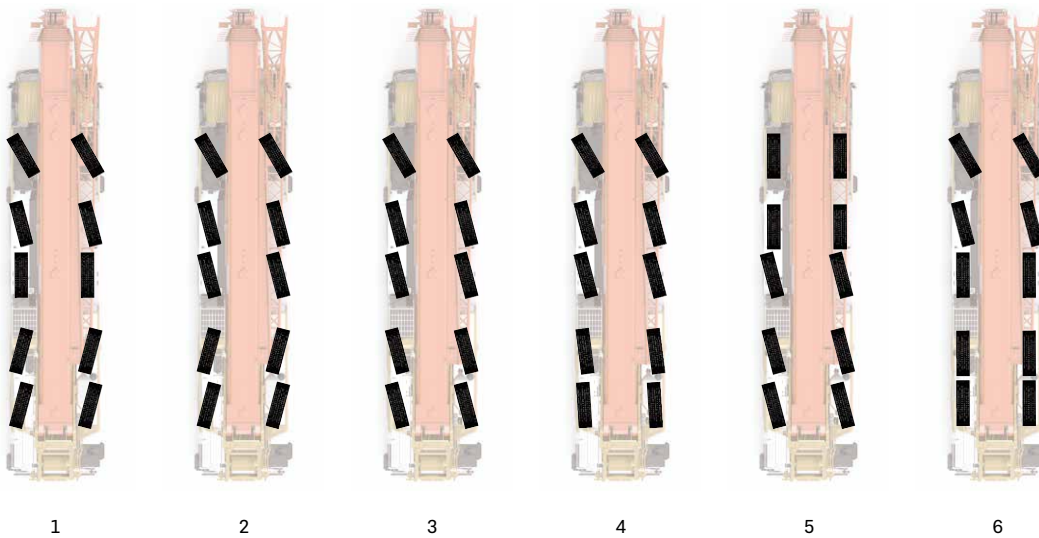

- 1 On-road driving 公路行驶
- 2 All-wheel steering 全轮转向
- 3 Crab steering 蟹行
- 4 Reduced swing-out steering 无偏摆转向
- 5 Independent rear axle steering 独立后桥转向
- 6 Rear axle locked mode steering 后桥锁定转向

Traveling with counterweight and hook block on board 带载行驶能力

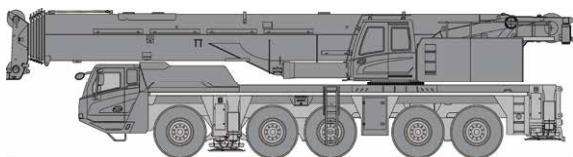

≤12t ≤12t ≤12t ≤12t ≤12t

≡ 0t

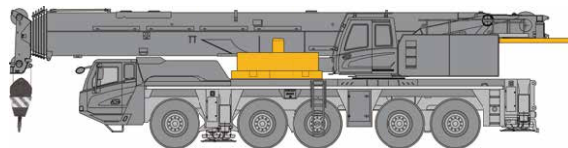

≤16.5t ≤16.5t ≤16.5t ≤16.5t ≤16.5t

≡ 22t (17t+5t)

Counterweight Combinations

配重组合

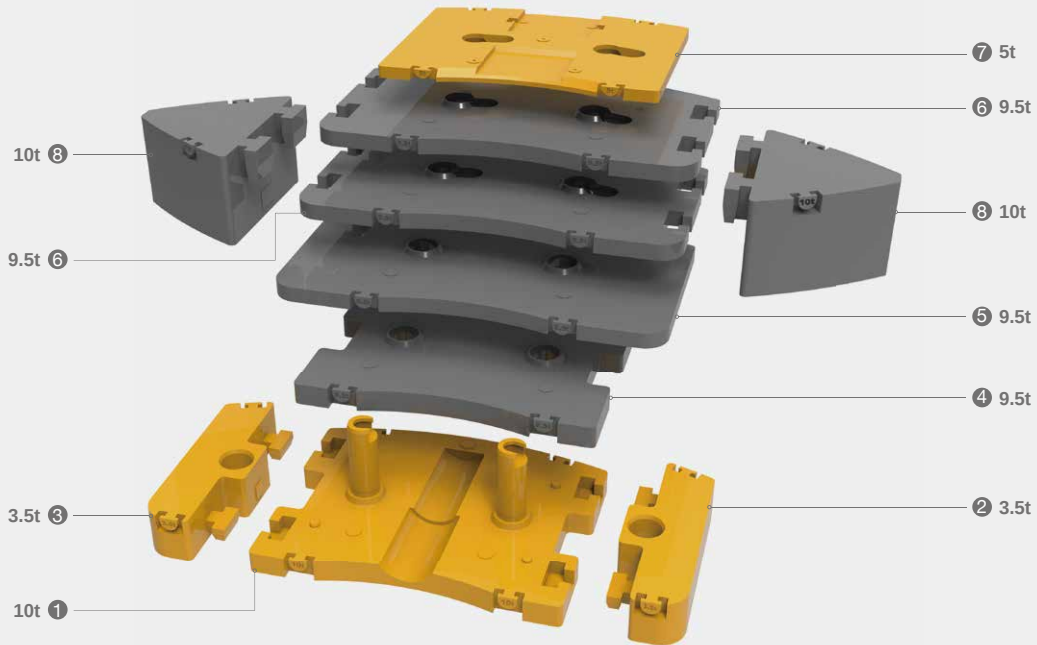

Total weight (t) 总重量	① 10t	② 3.5t	③ 3.5t	④ 9.5t	⑤ 9.5t	⑥ 9.5t	⑦ 5t	⑧ 10t
0								
5							•	
10	•							
15	•						•	
17	•	•	•					
22	•	•	•				•	
26.5	•	•	•	•				
31.5	•	•	•	•			•	
36	•	•	•	•	•			
41	•	•	•	•	•		•	
45.5	•	•	•	•	•	•		
50.5	•	•	•	•	•	•	•	
55	•	•	•	•	•	2*•		
60	•	•	•	•	•	2*•	•	
80	•	•	•	•	•	2*•	•	2*•

Remark: blocks in yellow can be carried on board when driving on jobsites.
备注：标黄色配重可随车短距离转场。

Transport Dimensions

运输尺寸

Unit:mm

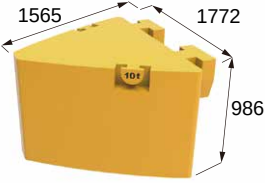
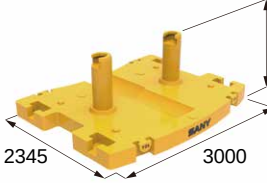
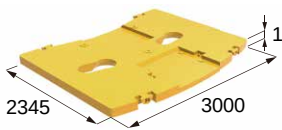
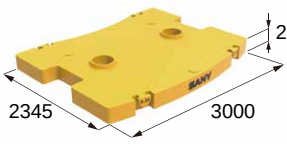
 <p>1565 1772 986 10t</p>	 <p>2345 3000 1041</p>	 <p>2345 3000 115</p>	 <p>735 2124 464 3.5t</p>
 <p>2345 4000 212</p>	 <p>2345 4000 220</p>	 <p>2345 3000 274</p>	 <p>735 2124 464 3.5t</p>
 <p>Φ402 976</p>	 <p>274 620 1436</p>	 <p>390 620 1541</p>	
<p>12.5t hook block</p>	<p>32t hook block</p>	<p>80t hook block</p>	
 <p>584 620 1760</p>	 <p>760 620 1910</p>		
<p>125t hook block</p>	<p>160t hook block</p>		

Jib Combinations



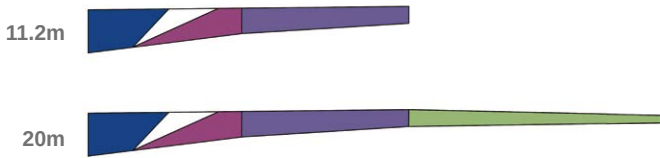

副臂组合

Fixed jib 固定副臂

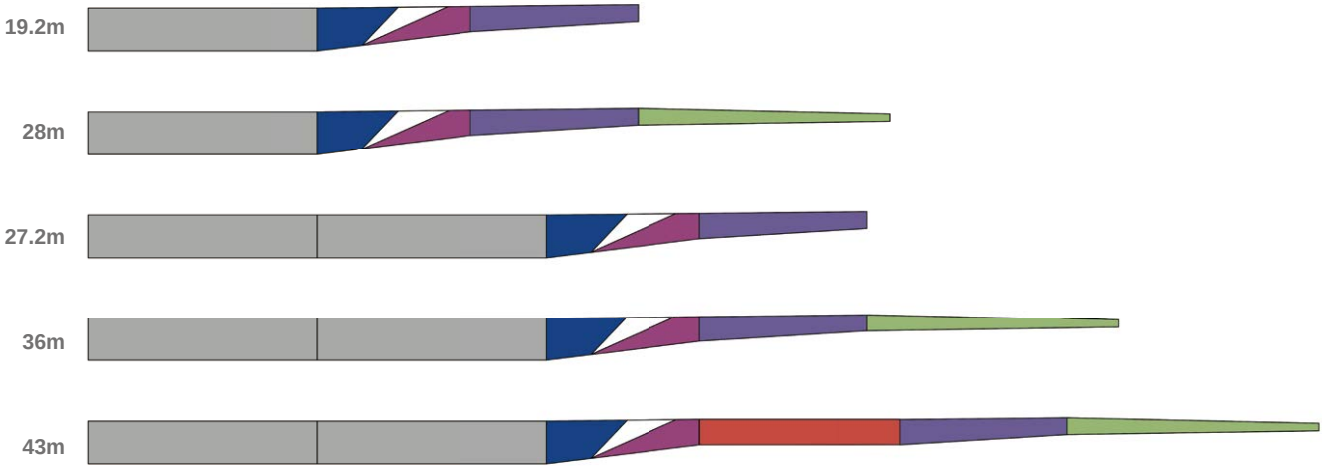

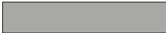
Boom extension with fixed jib 主臂延伸节 + 固定副臂



- 8m  8m boom extension
8m 主臂延伸节
- 5.1m  5.1m adapter
5.1m 转动段
- 7m  7m insert
7m 副臂延伸节
- 6.1m  6.1m tapered section
6.1m 桁架副臂
- 8.8m  8.8m foldable section
8.8m 折叠副臂

Crane Introduction

整机介绍

Carrier 下车

Driver's cab 驾驶室

- Three seats with a folding berth. It's soundproofing performance meets the standard of heavy duty trucks. Air suspension seat features shock absorption, back adjustment, lumbar support and other ergonomic designs. Virtual LCD instrument and 12.1" console screen integrate auto control of air conditioning. Indoor temperature can be adjusted precisely and smoothly. LED headlights, electrically heated rear-view mirrors, multifunction steering wheel. The multi-media equipment can be controlled by the buttons integrated in the steering wheel.
- 三座椅，二合一卧铺。车门关闭后，隔音性达到国际重卡水平。空气悬浮减震座椅，集成背部调节、气囊腰托、人体工程学配置。液晶、虚拟仪表盘。12.1寸中控大屏；集成自动空调控制界面，精准控温，出风平顺。LED前大灯，电动电热后视镜；多功能方向盘，可控制车内多媒体设备。

Carrier frame 车架

- Anti-distortion box-type welded structure using high strength steel plate, higher bearing capacity.
- 细晶粒高强度钢板焊接而成的防扭转箱形结构，承载能力强。

Engine 发动机

- Model: BENZ OM471LA inline six-cylinder diesel engine with watercooler and inter cooler.
- Emission standard: E3A / E5.
- Fuel reservoir capacity: 450L.
- 型号：奔驰 OM471LA，直列六缸、水冷却、增压中冷、柴油发动机。
- 排放标准：E3A / E5。
- 燃料箱有效容积：450L。

Transmission 变速箱

- AMT, 12 forward speeds and 2 reverse speeds, large speed ratio range, adaptable to slope climbing and high-speed traveling.
- 手自一体变速箱，变速箱有12个前进挡、2个后退挡，速比范围大，既可满足低速场地爬坡行驶又可满足高速行驶。

Axle 车桥

- Kessler. Axles 2, 4, 5 are drive axles of planetary transmission with inter-wheel differential lock, and axle 4 is fitted with inter-axle differential. All axles are steered. Axles 1, 2 adopt power steering with linkage feedback, and axles 3, 4, 5 are steered hydraulically.
- 德国 Kessler 车桥，2、4、5 桥驱动，所有驱动桥为行星传动带有轮间差速锁，4 桥带有轴间差速锁。全桥转向，1、2 桥采用杆系反馈的液压助力转向系统，3、4、5 桥采用电液控制转向。

Suspension system 悬挂

- All axles equipped with hydro-pneumatic suspension with hydraulic lockout, height adjustable up by 165mm and down by 125mm. Driving comfort and lateral stability is therefore guaranteed on rough terrains and conditions.
- 全部车桥悬架装置均为高度可调带液压闭锁的油气悬架装置。悬挂高度可上 165mm，下 125mm 调节，能适用各种恶劣工况和路面，保证车辆行驶的平顺性和侧翻稳定性，驾驶舒适。

Steering 转向系统

- Six steering modes incl. on-road driving (default), all-wheel steering, crab steering, reduced swing-out steering, independent rear axle steering, independent front axle steering.
- 转向模式共六种：公路行驶模式（默认模式），全轮转向模式，蟹形模式，无偏摆转向模式，独立后桥转向模式，后桥锁定转向模式。

Tires 轮胎

- 11 tires sized 385/95 R25(14.00 R25), strong bearing capacity and durability.
- 11（轮胎数）—轮胎规格：385/95 R25(14.00 R25)，承载能力强，耐用。

Wheel formula 车轮模式

- 10 × 6 × 10.

Outrigger 支腿

- H-type layout, four point support, two-stage outrigger beam hydraulically telescoping, outrigger jack protected by two-way holding valve.
- H 型支腿 4 点支撑，采用细晶粒高强度钢板材料，一、二级支腿全液压横向伸缩。垂直油缸采用双向液压锁进行安全保护。

Brake 制动系统

- Service brake: dual circuit, air servo on all wheels, caliper disc brake and double air chambers on axles 1and 2.
- Assisting brake: transmission hydraulic retarder, safety assured when driving down long slopes.
- 行车制动采用双回路制动系统，所有车轮均用空气伺服制动器，钳盘式制动器 + 一、二桥双气室，制动能力更强。
- 辅助制动为变速箱液力缓速，保证在下长坡时的制动安全，保证行车的安全可靠。

Electrical system 电气系统

- CAN BUS instrument, IP65, low power consumption of 5W. Multi-functional display system, LCD screen of adjustable contrast ratio.
- CAN 总线系统，防护等级 IP65，功率消耗小，最大仅有 5W，多功能的集中显示系统，LCD 液晶显示屏，对比度可调整。

Crane Introduction

整机介绍

superstructure 上车

Operator's cab 操纵室

- Curved track sliding door, foldable front step and electric side step. The seat and armrest can be adjusted steplessly in multi ways electrically. Auto air conditioning system gives out airflow from various vents once pressing the virtual key. Windshield wiper covers large area, ensuing clear vision in heavy rains. Double 10.1" frameless displays of all new UI is equipped. Operation is realized via touchscreen and buttons.
- 变轨滑移门，电动滑移踏板，折叠式前踏板；座椅、扶手箱多维度电动无极调节；汽车级集成式硬质按键，配置全自动空调，多通道立体送风系统，虚拟空调按键，前窗分体式大面积雨刮；双 10.1 寸无框大屏，全新 UI 界面，触摸、按键多模式操作。

Engine 发动机

- Model: Cummins QSB7/B6.7 inline six-cylinder diesel engine with watercooler and inter cooler.
- Emission standard: E3A / E5.
- Fuel reservoir capacity: 200L.
- 型式：康明斯 QSB7/B6.7，直列六缸、水冷却、增压中冷、柴油发动机。
- 排放标准：E3A / E5。
- 燃料箱有效容积：200L。

Boom & telescoping system 伸缩系统

- 7 section boom, bending resistant U shape structure welded by high tensile steel plate. Telescoping via single cylinder with auto pinning. One double-acting cylinder controls all sections to realized variable boom lengths.
- 臂结构采用抗扭曲设计，采用高强度钢板制作，7 节 U 型主臂。伸缩采用单缸自动插销式系统，一个双作用油缸可以控制所有起重臂的伸缩，达到多种臂长组合。

Hoist 起升系统

- Main winch adopts electro-proportional variable motor for better inching mobility and operation smoothness. Stepless speed control.
- 主卷扬采用电比例变量马达，卷扬微动性、平稳性好，能实现无级变速。

Luffing system 变幅系统

- Dual pump confluent-flow open loop, electro-proportional control. Passive luffing down, realizing fast lowering at large elevation and stable lowering at small elevation.
- 双泵合流开式液压回路，电比例控制，自重落幅，可实现大角度快速落幅，小角度稳定慢速落幅。

Slewing 回转系统

- Dual motor drive.
- 双回转驱动系统，回转平稳可靠。

Counterweight 配重

- Movable counterweight features 15 combinations: 0t, 5t, 10t, 15t, 17t, 22t, 26.5t, 31.5t, 36t, 41t, 45.5t, 50.5t, 55t, 60t, 80t. See variable CW combination chart. CW assembly and disassembly controlled by remote device.
- 组合式可变平衡重。0t、5t、10t、15t、17t、22t、26.5t、31.5t、36t、41t、45.5t、50.5t、55t、60t、80t，共 15 种组合方式，详见附件组合表，可满足不同工况的需求，最大限度发挥结构件性能，可遥控拆卸及安装，微动性好。

Safety equipment 安全装置

- Hydraulic system reliability is guaranteed by balance valve, relief valve, and two-way holding valve.
- Length & angle indicator and pressure sensor are equipped to show real-time operation status. Hazardous motions are cut off automatically with buzzer alarming.
- 液压系统配置液压平衡阀、溢流阀、双向液压锁等元件，实现液压系统稳定可靠。
- 配置长度角度传感器、压力传感器，实时显示起重机作业状态，自动切断危险动作，蜂鸣报警。

Optional equipment at extra fees 选配

- Aux. winch
- Jib
- 32t, 125t, 160t hook blocks
- Superstructure emergency system
- Boom tip camera
- 445 or 525 tires
- Customized painting
- Other equipment available upon request
- 副卷扬
- 副臂
- 32t、125t、160t 吊钩
- 上车应急系统
- 臂头监视系统
- 445 和 525 轮胎
- 特殊涂装
- 其他配置视需求定

Working Conditions & Code Description

工况组合及工况代码说明

- T - Telescopic boom 主臂
- J - Fixed jib 固定副臂
- E - Boom extension 主臂延伸节
- H - Hydraulically adjustable jib 液压变幅副臂



T

TJ/TH

TEJ/TEH

TE2J/TE2H

Operating Range - T

起升高度曲线 - 主臂

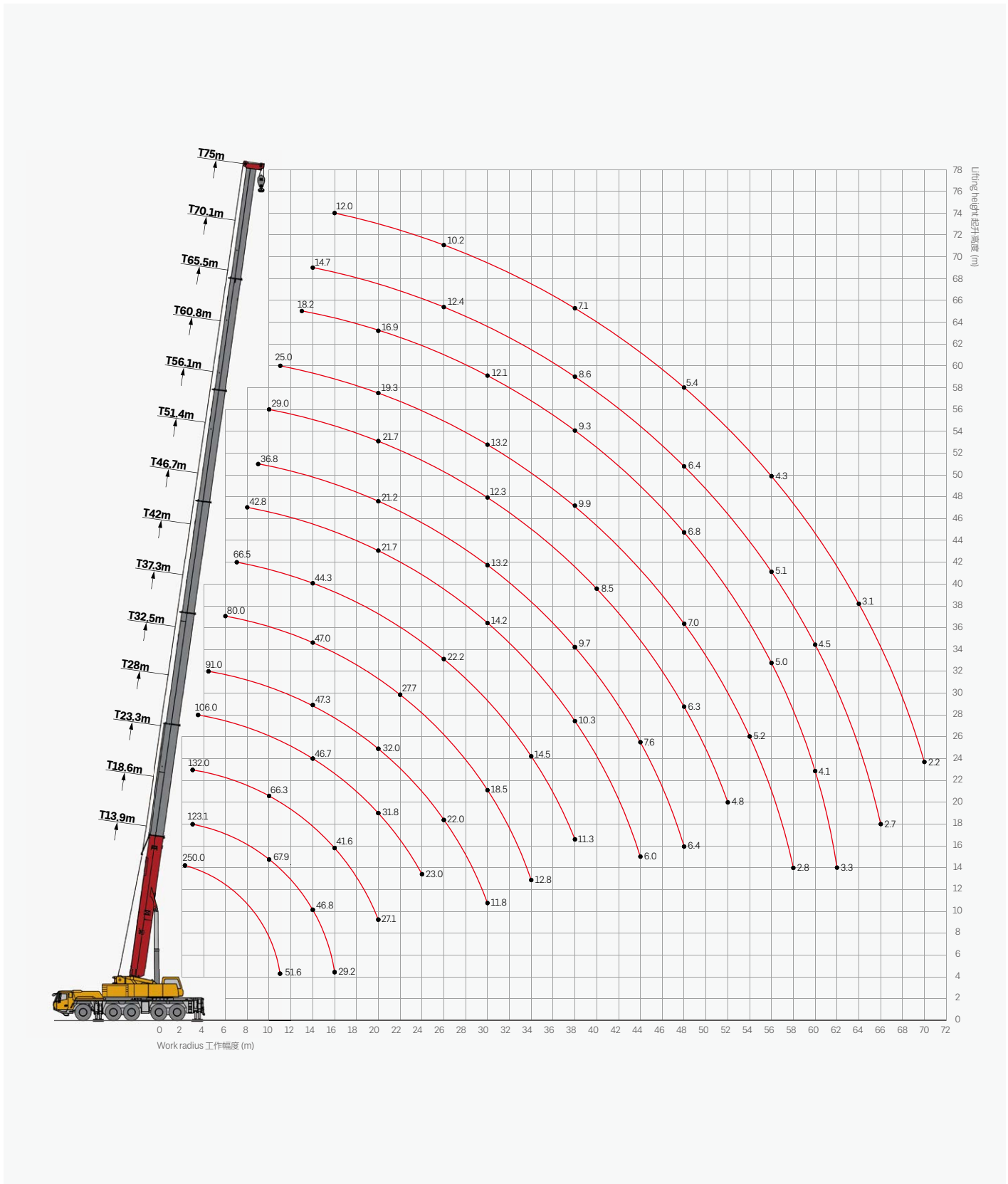



Load Chart-T

性能表 - 主臂

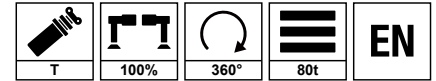
Unit: t



 m	13.9	18.6	23.3	28.0	32.5	37.3	42.0	46.7	51.4	56.1	60.8	65.5	70.1	75.0	 m
2.5	250*														2.5
3	134.0	123.1	132.0												3
3.5	134.0	123.1	129.8	106.0											3.5
4	130.5	123.1	122.8	106.0											4
4.5	122.1	117.7	114.6	106.0	91.0										4.5
5	114.7	110.6	107.5	100.2	91.0										5
6	102.1	98.6	95.6	94.1	89.5	80.0									6
7	91.5	88.9	86.2	84.7	82.4	76.0	66.5								7
8	82.2	80.8	78.4	77.1	75.4	69.0	66.5	42.8							8
9	73.8	73.9	71.9	70.7	68.5	67.1	62.7	42.8	36.8						9
10	64.3	67.9	66.3	65.3	62.7	61.8	57.9	41.6	36.8	29.0					10
11	51.6	62.4	61.4	59.7	58.5	57.6	54.2	39.0	36.2	29.0	25.0				11
12		57.2	57.1	55.0	54.5	53.5	50.4	36.8	33.9	29.0	25.0				12
13		52.2	52.5	50.7	50.7	50.2	47.2	34.6	32.3	29.0	25.0	18.2			13
14		46.8	48.4	46.7	47.3	47.0	44.3	33.0	30.5	28.4	24.6	18.2	14.7		14
16		29.2	41.6	40.9	40.9	41.9	39.4	29.4	27.7	26.0	22.7	18.2	14.7	12.0	16
18			35.6	36.4	35.9	37.2	35.7	26.2	25.0	23.7	20.9	18.2	14.7	12.0	18
20			27.1	31.8	32.0	32.0	32.4	21.7	21.2	21.7	19.3	16.9	14.7	12.0	20
22				27.5	28.4	27.7	28.6	19.6	19.1	19.2	17.9	15.9	13.9	11.8	22
24				23.0	24.9	24.2	25.1	17.9	17.2	16.1	16.7	14.7	13.1	11.0	24
26					22.0	21.4	22.2	16.6	15.5	14.5	15.4	13.8	12.4	10.2	26
28					19.6	20.0	19.8	15.3	14.3	13.3	14.4	13.0	11.6	9.6	28
30					11.8	18.5	17.8	14.2	13.2	12.3	13.2	12.1	11.0	9.1	30
32						16.7	16.0	13.2	12.1	11.3	12.3	11.4	10.3	8.5	32
34						12.8	14.5	12.1	11.2	10.5	11.5	10.6	9.8	8.1	34
36							13.1	11.0	10.4	9.8	10.8	9.9	9.2	7.6	36
38							11.3	10.3	9.7	9.0	9.9	9.3	8.6	7.1	38
40								9.2	9.0	8.5	9.3	8.7	8.2	6.8	40
42								8.5	8.3	7.8	8.7	8.2	7.7	6.3	42
44								6.0	7.6	7.3	8.1	7.7	7.3	6.0	44
46									7.0	6.8	7.5	7.3	6.9	5.7	46
48									6.4	6.3	7.0	6.8	6.4	5.4	48
50										5.9	6.4	6.4	6.1	5.2	50
52										4.8	5.8	6.0	5.8	4.8	52
54											5.2	5.5	5.4	4.6	54
56											4.9	5.0	5.1	4.3	56
58											2.8	4.6	4.8	4.0	58
60												4.1	4.5	3.7	60
62												3.3	4.1	3.5	62
64													3.8	3.1	64
66													2.7	2.8	66
68														2.6	68
70														2.2	70

* load over rear, requiring additional equipment.



* 特殊配置正后方吊载。

Load Chart-T

性能表 - 主臂

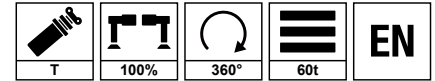
Unit: t





 m	13.9	18.6	23.3	28.0	32.5	37.3	42.0	46.7	51.4	56.1	60.8	65.5	70.1	75.0	 m
3	134.0	123.1	132.0												3
3.5	134.0	123.1	129.8	106.0											3.5
4	130.5	123.1	122.8	106.0											4
4.5	122.1	117.7	114.6	106.0	91.0										4.5
5	114.3	110.6	107.5	100.2	91.0										5
6	101.0	98.6	95.6	94.1	89.5	80.0									6
7	90.3	88.9	86.2	84.7	82.4	76.0	66.5								7
8	81.0	80.8	78.4	77.1	75.4	69.0	66.5	42.8							8
9	71.8	72.2	71.9	70.7	68.5	67.1	62.7	42.8	36.8						9
10	64.3	64.7	64.7	65.3	62.7	61.8	57.9	41.6	36.8	29.0					10
11	51.6	58.5	58.5	59.2	58.5	55.5	54.2	39.0	36.2	29.0	25.0				11
12		53.3	53.3	53.7	52.8	50.0	49.3	36.8	33.9	29.0	25.0				12
13		48.5	49.0	48.5	47.8	45.3	44.9	34.6	32.3	29.0	25.0	18.2			13
14		43.2	43.6	43.4	43.7	41.4	41.1	33.0	30.5	28.4	24.6	18.2	14.7		14
16		29.2	35.5	35.7	36.3	35.0	35.0	29.4	27.7	26.0	22.7	18.2	14.7	12.0	16
18			29.6	30.7	30.3	29.6	30.2	26.2	25.0	23.7	20.9	18.2	14.7	12.0	18
20			25.5	26.1	25.8	26.7	26.0	21.7	21.2	21.7	19.3	16.9	14.7	12.0	20
22				22.5	22.2	23.1	22.4	19.6	19.1	19.2	17.9	15.9	13.9	11.8	22
24				19.6	19.3	20.2	19.5	17.9	17.2	16.1	16.7	14.7	13.1	11.0	24
26					16.9	17.8	17.1	16.4	15.5	14.5	15.4	13.8	12.4	10.2	26
28					14.9	15.8	15.1	14.4	14.3	13.3	14.4	13.0	11.6	9.6	28
30					11.8	14.1	13.4	12.8	12.6	12.3	13.0	12.1	11.0	9.1	30
32						12.6	12.0	11.3	11.2	11.3	11.6	11.4	10.3	8.5	32
34						11.4	10.7	10.1	9.9	10.1	10.3	10.6	9.8	8.1	34
36							9.7	9.3	9.2	9.2	9.4	9.6	9.2	7.6	36
38							8.8	8.6	8.6	8.6	8.7	8.6	8.6	7.1	38
40								7.9	8.1	7.8	8.1	7.8	8.1	6.8	40
42								7.2	7.6	7.1	7.6	7.2	7.3	6.3	42
44								6.0	7.1	6.6	7.1	6.8	6.6	6.0	44
46									6.6	6.1	6.7	6.3	6.0	5.7	46
48									6.0	5.6	6.1	5.9	5.4	5.4	48
50										5.1	5.5	5.3	4.8	4.9	50
52										4.7	5.1	4.8	4.3	4.4	52
54											4.6	4.4	3.9	3.9	54
56											4.3	3.9	3.5	3.5	56
58											2.8	3.6	3.1	3.1	58
60												3.2	2.7	2.8	60
62												2.8	2.4	2.4	62
64													2.1	2.1	64
66													1.8	1.8	66
68														1.5	68
70														1.3	70

Load Chart-T

性能表 - 主臂

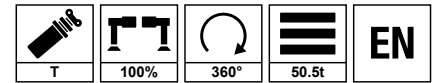
Unit: t





 m	13.9	18.6	23.3	28.0	32.5	37.3	42.0	46.7	51.4	56.1	60.8	65.5	70.1	75.0	 m
3	134.0	123.1	132.0												3
3.5	134.0	123.1	129.8	106.0											3.5
4	130.5	123.1	122.8	106.0											4
4.5	121.5	117.7	114.6	106.0	91.0										4.5
5	113.6	110.6	107.5	100.2	91.0										5
6	100.4	98.6	95.6	94.1	89.5	80.0									6
7	89.3	88.9	86.2	84.7	82.4	76.0	66.5								7
8	78.2	78.5	78.4	77.1	75.4	69.0	66.5	42.8							8
9	69.4	69.7	69.7	68.5	66.5	62.4	60.9	42.8	36.8						9
10	62.1	62.4	61.9	59.9	58.5	55.0	54.0	41.6	36.8	29.0					10
11	51.6	56.1	55.9	53.0	52.0	49.0	48.3	39.0	36.2	29.0	25.0				11
12		48.7	49.2	47.4	46.7	44.1	43.6	36.8	33.9	29.0	25.0				12
13		42.8	43.3	44.1	42.2	39.9	39.6	34.6	32.3	29.0	25.0	18.2			13
14		38.0	38.5	39.7	38.5	36.7	36.2	33.0	30.5	28.4	24.6	18.2	14.7		14
16		29.2	31.2	32.3	31.9	32.5	30.7	28.9	27.7	26.0	22.7	18.2	14.7	12.0	16
18			26.8	26.9	26.5	27.5	26.4	24.8	24.0	23.5	20.9	18.2	14.7	12.0	18
20			22.7	22.8	22.5	23.4	22.7	21.5	20.8	20.4	19.3	16.9	14.7	12.0	20
22				19.6	19.2	20.1	19.4	18.7	18.2	18.2	17.8	15.9	13.9	11.8	22
24				17.5	16.6	17.5	16.8	16.1	16.0	16.1	15.7	14.7	13.1	11.0	24
26					14.5	15.4	14.7	14.2	14.1	14.2	14.2	13.8	12.4	10.2	26
28					12.7	13.6	13.1	13.0	12.8	13.3	12.6	12.5	11.6	9.6	28
30					11.1	12.0	11.6	11.6	11.7	11.8	11.8	11.2	11.0	9.1	30
32						10.7	10.2	10.3	10.5	10.9	10.5	10.3	10.3	8.5	32
34						9.6	9.4	9.4	9.8	9.8	9.8	9.5	9.3	8.1	34
36							8.5	8.6	8.9	8.7	9.0	8.8	8.3	7.6	36
38							7.6	7.9	8.0	7.8	8.3	7.9	7.4	7.1	38
40								7.1	7.3	7.0	7.5	7.1	6.6	6.7	40
42								6.6	6.7	6.6	6.8	6.4	5.9	5.9	42
44								6.0	6.1	6.1	6.1	5.7	5.3	5.3	44
46									5.5	5.7	5.5	5.2	4.7	4.7	46
48									4.9	5.3	5.0	4.6	4.1	4.2	48
50										4.9	4.5	4.1	3.7	3.7	50
52										4.4	4.1	3.7	3.2	3.3	52
54											3.6	3.3	2.8	2.8	54
56											3.3	2.9	2.4	2.5	56
58											2.8	2.5	2.1	2.1	58
60												2.2	1.7	1.8	60
62												1.9	1.4	1.5	62
64													1.1	1.2	64
66													0.9	0.9	66
68														0.7	68

Load Chart-T

性能表 - 主臂

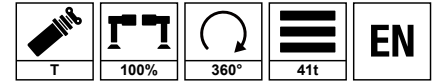
Unit: t





 m	13.9	18.6	23.3	28.0	32.5	37.3	42.0	46.7	51.4	56.1	60.8	65.5	70.1	75.0	 m
3	134.0	123.1	132.0												3
3.5	134.0	123.1	129.8	106.0											3.5
4	129.7	123.1	122.8	106.0											4
4.5	120.7	117.7	114.6	106.0	91.0										4.5
5	112.9	110.6	107.5	100.2	91.0										5
6	99.8	98.6	95.6	94.1	89.5	80.0									6
7	86.2	86.5	86.2	83.0	79.3	73.6	66.5								7
8	75.4	75.7	74.5	69.8	67.3	62.8	61.0	42.8							8
9	66.8	67.1	63.7	60.1	58.2	54.5	53.3	42.8	36.8						9
10	56.0	57.5	55.3	54.0	51.1	47.9	47.1	41.6	36.8	29.0					10
11	47.5	49.0	48.7	47.8	45.3	44.6	42.1	39.0	36.2	29.0	25.0				11
12		42.5	42.9	42.8	40.6	40.2	37.9	35.7	33.9	29.0	25.0				12
13		37.8	37.6	38.6	36.7	36.5	34.4	32.3	31.1	29.0	25.0	18.2			13
14		33.5	34.4	34.5	33.3	33.3	31.3	29.4	28.3	27.6	24.6	18.2	14.7		14
16		26.9	27.9	28.0	27.6	28.1	26.4	25.0	23.8	23.6	22.7	18.2	14.7	12.0	16
18			23.7	23.6	22.8	23.7	22.5	22.2	21.5	20.9	19.7	18.2	14.7	12.0	18
20			20.2	20.6	19.2	20.1	19.5	19.2	19.0	18.1	17.7	16.9	14.7	12.0	20
22				17.7	16.3	17.2	16.7	16.7	16.7	16.6	15.9	14.9	13.9	11.8	22
24				15.4	14.0	14.9	14.6	14.4	14.7	14.8	14.0	13.6	13.1	11.0	24
26					12.1	12.9	12.9	12.9	13.3	13.1	12.9	12.6	11.8	10.2	26
28					11.1	11.5	11.3	11.6	11.7	11.5	12.0	11.3	10.5	9.6	28
30					10.3	10.1	10.0	10.2	10.4	10.4	10.6	10.1	9.3	9.1	30
32						9.0	8.8	9.2	9.4	9.4	9.4	9.0	8.3	8.2	32
34						7.9	7.8	8.6	8.3	8.8	8.4	8.0	7.4	7.3	34
36							7.1	7.9	7.4	7.9	7.5	7.1	6.6	6.5	36
38							6.6	7.1	6.6	7.1	6.7	6.3	5.8	5.8	38
40								6.4	5.9	6.4	6.0	5.6	5.1	5.1	40
42								5.7	5.3	5.7	5.3	5.0	4.5	4.5	42
44								5.1	4.7	5.1	4.8	4.4	3.9	3.9	44
46									4.2	4.6	4.2	3.9	3.4	3.4	46
48									3.7	4.1	3.8	3.4	2.9	2.9	48
50										3.7	3.3	3.0	2.5	2.5	50
52										3.3	2.9	2.6	2.1	2.1	52
54											2.6	2.2	1.7	1.7	54
56											2.2	1.8	1.4	1.4	56
58											1.9	1.5	1.0	1.0	58
60												1.2	0.7	0.7	60
62												0.9			62

Load Chart-T

性能表 - 主臂

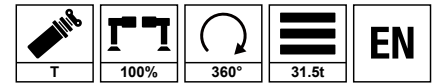
Unit: t





 m	13.9	18.6	23.3	28.0	32.5	37.3	42.0	46.7	51.4	56.1	60.8	65.5	70.1	75.0	 m
3	134.0	123.1	132.0												3
3.5	134.0	123.1	129.8	106.0											3.5
4	128.8	123.1	122.8	106.0											4
4.5	119.9	117.7	114.6	106.0	91.0										4.5
5	111.7	110.6	107.5	100.2	91.0										5
6	96.5	96.6	93.5	87.7	82.9	76.2									6
7	83.1	82.5	77.0	72.4	68.4	63.4	61.2								7
8	72.0	68.1	64.2	61.9	57.9	56.3	52.5	42.8							8
9	57.8	57.6	54.6	53.1	50.0	48.9	45.7	42.7	36.8						9
10	47.8	49.3	47.3	46.3	43.7	43.0	40.4	37.7	36.0	29.0					10
11	40.4	42.5	41.5	40.9	38.7	38.3	36.1	33.6	32.1	29.0	25.0				11
12		36.7	37.7	36.5	34.5	34.4	32.5	30.9	29.3	28.7	25.0				12
13		32.1	33.1	32.8	31.1	31.0	29.3	28.4	27.7	26.4	24.9	18.2			13
14		28.4	29.3	30.5	28.1	28.2	26.7	25.8	25.3	24.1	22.7	18.2	14.7		14
16		23.1	24.4	24.8	23.3	23.7	22.3	21.7	21.4	21.2	20.2	18.2	14.7	12.0	16
18			20.1	20.5	19.1	20.0	19.5	18.4	18.9	18.2	17.5	16.6	14.7	12.0	18
20			16.9	17.3	15.9	17.0	16.8	16.6	16.4	16.0	15.9	15.0	14.1	12.0	20
22				14.8	14.1	14.4	14.2	14.5	14.5	14.7	13.9	13.1	12.2	11.8	22
24				12.7	13.0	12.4	12.2	13.0	12.8	13.0	12.2	11.5	10.7	10.4	24
26					11.8	10.7	10.5	11.6	11.1	11.6	10.8	10.2	9.3	9.1	26
28					10.4	9.3	9.5	10.1	9.7	10.2	9.6	9.0	8.2	8.0	28
30					9.2	8.1	8.9	8.9	8.5	8.9	8.5	7.9	7.2	7.0	30
32						7.0	8.1	7.9	7.5	7.9	7.5	7.0	6.3	6.2	32
34						6.5	7.4	7.0	6.6	7.0	6.6	6.2	5.5	5.4	34
36							6.6	6.2	5.8	6.2	5.8	5.4	4.8	4.7	36
38							5.9	5.5	5.1	5.5	5.1	4.7	4.1	4.0	38
40								4.9	4.4	4.9	4.5	4.1	3.5	3.5	40
42								4.3	3.9	4.3	3.9	3.4	2.9	2.9	42
44								3.8	3.3	3.8	3.3	2.9	2.3	2.4	44
46									2.8	3.3	2.8	2.4	1.9	1.9	46
48									2.3	2.8	2.4	1.9	1.4	1.4	48
50										2.4	1.9	1.6	1.0	1.0	50
52										2.0	1.6	1.1			52
54											1.2	0.8			54
56											0.9				56

Load Chart-T

性能表 - 主臂

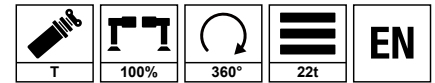
Unit: t





 m	13.9	18.6	23.3	28.0	32.5	37.3	42.0	46.7	51.4	56.1	60.8	65.5	70.1	75.0	 m
3	134.0	123.1	132.0												3
3.5	134.0	123.1	129.8	106.0											3.5
4	128.0	123.1	122.8	106.0											4
4.5	119.2	117.7	114.6	106.0	91.0										4.5
5	110.3	110.6	103.0	94.8	88.2										5
6	93.0	87.7	80.7	75.2	70.0	66.8									6
7	74.4	69.5	64.8	62.1	57.6	55.6	51.7								7
8	60.4	57.9	53.8	52.0	48.6	47.3	44.2	40.7							8
9	48.2	48.8	47.0	45.0	41.7	41.0	38.4	36.7	35.0						9
10	39.7	41.8	40.6	40.2	36.3	35.9	33.7	32.4	31.4	29.0					10
11	33.3	35.4	35.6	35.5	32.0	31.8	29.9	28.8	28.2	27.1	24.8				11
12		30.4	32.3	31.6	28.5	28.5	27.4	25.8	25.9	24.8	23.5				12
13		26.4	28.3	28.4	25.5	25.8	24.7	23.8	23.6	22.5	21.6	18.2			13
14		23.7	25.0	25.5	22.9	23.4	22.4	21.9	21.7	20.8	20.4	18.1	14.7		14
16		18.7	20.0	20.5	18.9	19.5	18.6	19.3	18.2	18.2	17.2	16.3	14.7	12.0	16
18			16.4	16.8	17.1	16.4	15.7	16.5	15.5	15.6	14.7	13.8	12.8	12.0	18
20			13.6	14.0	14.9	13.7	13.8	14.2	13.2	13.4	12.6	11.8	10.8	10.6	20
22				11.8	12.7	11.5	12.5	12.3	11.4	11.6	10.8	10.1	9.2	9.0	22
24				10.5	10.9	9.7	11.0	10.6	9.9	10.1	9.4	8.7	7.8	7.7	24
26					9.3	8.8	9.5	9.1	8.6	8.8	8.1	7.5	6.7	6.5	26
28					8.1	8.1	8.3	7.8	7.3	7.8	7.1	6.5	5.7	5.5	28
30					6.9	7.4	7.2	6.7	6.1	6.7	6.2	5.6	4.8	4.7	30
32						6.5	6.2	5.7	5.2	5.8	5.3	4.8	4.0	3.9	32
34						5.6	5.3	4.8	4.4	4.9	4.4	4.0	3.4	3.3	34
36							4.7	4.1	3.6	4.1	3.7	3.3	2.7	2.7	36
38							4.0	3.5	3.0	3.5	3.0	2.6	2.0	2.1	38
40								2.9	2.4	2.9	2.5	2.0	1.5	1.5	40
42								2.4	1.9	2.4	1.9	1.5	0.9	1.0	42
44								1.8	1.4	2.0	1.5	1.1			44
46									1.0	1.5	1.0				46
48										1.1	0.7				48
50										0.8					50

Load Chart-T

性能表 - 主臂

Unit: t



 m	13.9	18.6	23.3	28.0	32.5	37.3	42.0	46.7	51.4	56.1	60.8	65.5	70.1	75.0	 m
3	134.0	123.1	132.0												3
3.5	134.0	123.1	111.1	93.9											3.5
4	120.3	102.3	88.4	79.5											4
4.5	93.8	83.7	74.3	67.1	59.5										4.5
5	76.3	69.7	63.6	59.6	51.6										5
6	54.5	51.4	49.6	46.2	40.4	39.1									6
7	41.5	40.1	39.5	37.3	36.0	31.5	31.7								7
8	28.7	32.6	31.9	30.2	29.6	26.9	26.5	24.3							8
9	20.9	24.8	26.2	25.1	24.9	24.1	22.5	20.7	19.0						9
10	15.6	19.2	21.3	22.2	21.4	20.7	19.4	17.8	16.3	16.2					10
11	11.8	15.3	17.2	18.8	18.5	18.0	16.9	15.5	14.2	14.2	13.0				11
12		12.2	14.1	15.6	16.0	15.8	14.9	13.6	12.4	12.5	11.4				12
13		9.9	11.7	13.2	13.5	14.0	13.1	12.0	10.9	11.0	10.0	9.1			13
14		8.0	9.7	11.2	11.5	12.0	11.7	10.6	9.6	9.8	8.8	8.0	6.9		14
16		5.1	6.8	8.2	8.5	8.9	8.7	8.1	7.5	7.7	6.9	6.1	5.2	5.0	16
18			4.7	6.0	6.4	6.8	6.5	5.9	5.3	6.0	5.4	4.7	3.8	3.6	18
20			3.1	4.4	4.8	5.2	4.9	4.3	3.8	4.3	3.8	3.3	2.6	2.6	20
22				3.2	3.4	3.9	3.6	3.1	2.5	3.1	2.6	2.1	1.4	1.5	22
24				2.2	2.5	2.8	2.6	2.1	1.5	2.1	1.6	1.1			24
26					1.6	2.0	1.8	1.3	0.7	1.3	0.8				26
28					0.9	1.3	1.1								28
30						0.7									30

Operating Range - TJ / TH

起升高度曲线 - 副臂

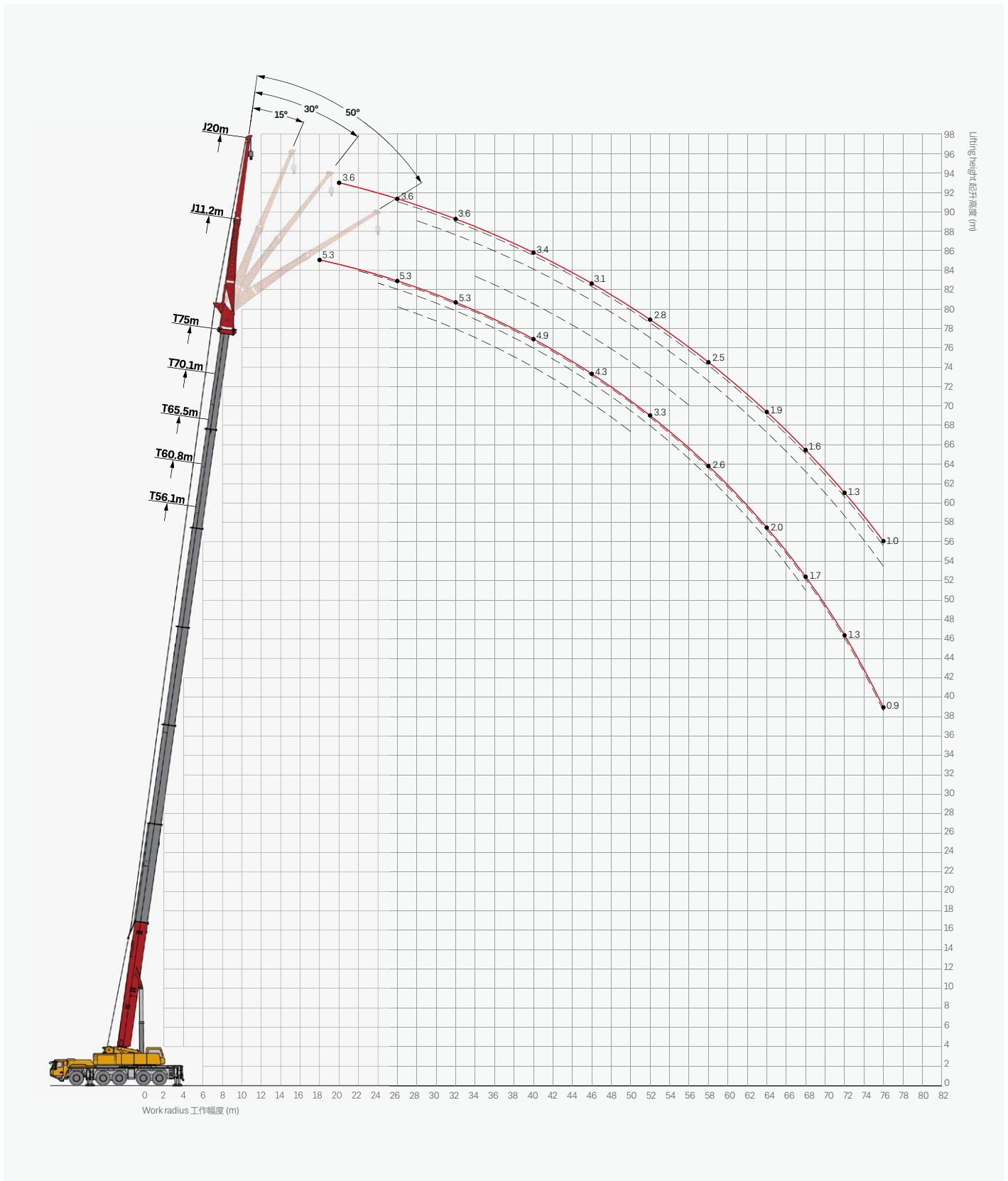

Load Chart-TJ / TH

性能表 - 副臂

Unit: t

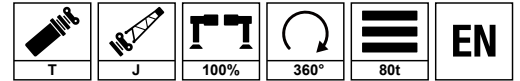

m	56.1				60.8				65.5				70.1				75.0				m
	11.2				11.2				11.2				11.2				11.2				
	0°	15°	30°	50°	0°	15°	30°	50°	0°	15°	30°	50°	0°	15°	30°	50°	0°	15°	30°	50°	
13	14.6																				13
14	14.6				13.0																14
16	14.6	9.9			12.9				11.2												16
18	14.5	9.6	6.6		12.8	10.3			11.0	10.8			6.9				5.3				18
20	14.1	9.3	6.4	4.9	12.5	10.1	6.6		10.9	10.6	6.7		6.9	7.0			5.3				20
22	13.7	9.0	6.3	4.8	12.3	9.9	6.5	4.8	10.8	10.4	6.7	4.8	6.9	7.0	6.0		5.3	5.3			22
24	13.2	8.6	6.1	4.7	11.9	9.6	6.4	4.7	10.5	10.2	6.7	4.7	6.9	7.0	6.0	5.1	5.3	5.3	5.3		24
26	12.6	8.2	5.9	4.6	11.3	9.1	6.3	4.6	10.0	9.7	6.7	4.6	6.9	7.0	6.0	5.1	5.3	5.3	5.3	5.4	26
28	12.0	7.9	5.8	4.6	10.8	8.7	6.2	4.6	9.6	9.3	6.7	4.6	6.9	7.0	6.0	5.0	5.3	5.3	5.3	5.4	28
30	11.3	7.5	5.7	4.5	10.2	8.3	6.2	4.5	9.1	8.9	6.7	4.5	6.9	7.0	6.0	4.9	5.3	5.3	5.3	5.4	30
32	10.6	7.1	5.5	4.5	9.6	7.9	6.1	4.5	8.6	8.5	6.7	4.5	6.9	6.9	6.0	4.9	5.3	5.3	5.3	5.3	32
34	9.8	6.8	5.4	4.4	9.0	7.5	6.1	4.4	8.2	8.1	6.7	4.4	6.7	6.7	6.0	4.8	5.3	5.3	5.3	5.2	34
36	9.1	6.4	5.3	4.4	8.4	7.1	6.0	4.4	7.8	7.7	6.7	4.4	6.4	6.5	6.0	4.8	5.1	5.2	5.2	5.2	36
38	8.4	6.1	5.2	4.4	7.9	6.7	5.9	4.4	7.3	7.2	6.7	4.4	6.2	6.2	5.9	4.7	5.1	5.2	5.2	5.1	38
40	7.8	5.9	5.0	4.4	7.3	6.3	5.9	4.4	6.8	6.7	6.7	4.4	5.8	5.9	5.9	4.7	4.9	5.0	5.0	4.9	40
42	7.3	5.7	5.0		6.8	6.0	5.8	4.3	6.3	6.3	6.6	4.3	5.6	5.6	5.8	4.6	4.8	4.9	4.9	4.9	42
44	6.7	5.4	5.0		6.3	5.6	5.5		5.9	5.9	6.0	4.3	5.3	5.3	5.4	4.5	4.7	4.8	4.8	4.7	44
46	6.0	5.1	4.9		5.7	5.2	5.2		5.4	5.4	5.5		4.9	4.9	5.0	4.3	4.3	4.3	4.3	4.3	46
48	5.3	4.9	4.7		5.2	5.0	4.9		5.0	5.1	5.1		4.6	4.6	4.7		4.0	4.0	4.0	4.1	48
50	4.6	4.5	4.3		4.7	4.6	4.5		4.7	4.7	4.8		4.2	4.3	4.3		3.6	3.7	3.6	3.8	50
52	4.2	4.1	4.0		4.3	4.2	4.2		4.3	4.4	4.4		4.0	4.0	4.0		3.3	3.4	3.4		52
54	3.9	3.9	3.9		4.0	4.0	4.0		4.0	4.1	4.1		3.7	3.8	3.8		3.1	3.1	3.1		54
56	3.7	3.8			3.7	3.7	3.8		3.7	3.7	3.7		3.4	3.6	3.6		2.8	2.9	2.9		56
58	3.4	3.5			3.4	3.4	3.3		3.3	3.3	3.3		3.2	3.3	3.2		2.6	2.7	2.7		58
60	3.0	3.1			3.1	3.1			3.1	3.1	3.1		3.0	3.1	3.0		2.4	2.5	2.4		60
62	2.8				2.9	2.9			2.9	2.9			2.8	2.9	2.8		2.3	2.3	2.3		62
64					2.6	2.6			2.8	2.7			2.7	2.7	2.6		2.0	2.1	2.0		64
66					2.3				2.6	2.6			2.5	2.5			1.9	1.9	1.8		66
68					0.8				2.3	2.3			2.3	2.3			1.7	1.8	1.7		68
70									2.0				2.0	2.0			1.5	1.5			70
72									0.9				1.7	1.8			1.3	1.3			72
74													1.5	1.6			1.0	1.0			74
76													1.0				0.9	0.9			76

Load Chart-TJ / TH

性能表 - 副臂

Unit: t

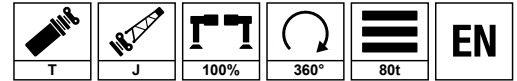

m	56.1				60.8				65.5				70.1				75.0				m	
	20.0				20.0				20.0				20.0				20.0					
	0°	15°	30°	50°	0°	15°	30°	50°	0°	15°	30°	50°	0°	15°	30°	50°	0°	15°	30°	50°		
16	6.0																				16	
18	5.9				5.3				4.7												18	
20	5.7	5.5			5.2				4.7				4.1					3.6			20	
22	5.5	5.3			5.0	5.0			4.6	4.8			4.1					3.6			22	
24	5.3	5.0	2.8		4.9	4.8			4.5	4.6			4.1	4.1				3.6			24	
26	5.1	4.7	2.7		4.7	4.6	2.8		4.4	4.5	2.8		4.0	4.1				3.6	3.7		26	
28	4.9	4.5	2.6	2.1	4.6	4.4	2.7		4.3	4.3	2.8		4.0	4.0	2.8			3.6	3.7	2.9	28	
30	4.7	4.3	2.5	2.1	4.4	4.2	2.6	2.1	4.2	4.1	2.7	2.1	3.9	3.9	2.7			3.6	3.7	2.8	30	
32	4.5	4.1	2.5	2.1	4.3	4.0	2.5	2.1	4.1	4.0	2.6	2.1	3.9	3.8	2.7	2.0		3.6	3.6	2.7	32	
34	4.3	3.9	2.4	2.0	4.2	3.9	2.5	2.0	4.0	3.8	2.5	2.0	3.8	3.7	2.6	2.0		3.6	3.6	2.6	2.0	34
36	4.1	3.7	2.3	2.0	4.0	3.7	2.4	2.0	3.9	3.7	2.5	2.0	3.7	3.6	2.6	2.0		3.6	3.5	2.6	2.0	36
38	4.0	3.6	2.3	2.0	3.9	3.6	2.4	2.0	3.8	3.6	2.4	2.0	3.6	3.5	2.5	2.0		3.5	3.5	2.5	2.0	38
40	3.8	3.4	2.3	2.0	3.8	3.4	2.3	2.0	3.7	3.4	2.4	2.0	3.5	3.4	2.4	2.0		3.4	3.3	2.5	2.0	40
42	3.7	3.3	2.2	2.0	3.6	3.3	2.3	2.0	3.6	3.3	2.4	2.0	3.4	3.3	2.4	2.0		3.3	3.3	2.5	2.0	42
44	3.5	3.1	2.2	2.0	3.5	3.1	2.2	2.0	3.5	3.1	2.3	2.0	3.3	3.2	2.3	2.0		3.2	3.2	2.4	2.0	44
46	3.3	3.0	2.2	1.9	3.4	3.0	2.2	1.9	3.4	3.0	2.3	1.9	3.2	3.1	2.3	2.0		3.1	3.1	2.4	2.0	46
48	3.2	2.8	2.1		3.3	2.9	2.1	1.9	3.3	2.9	2.2	1.9	3.1	3.0	2.2	2.0		3.0	3.1	2.3	2.0	48
50	3.0	2.7	2.1		3.1	2.7	2.1	1.9	3.1	2.8	2.2	1.9	3.0	2.9	2.2	1.9		2.9	3.0	2.3	1.9	50
52	3.0	2.6	2.0		3.0	2.6	2.1		3.0	2.7	2.2	1.9	2.9	2.8	2.2	1.9		2.8	2.8	2.3	1.9	52
54	2.9	2.5	2.0		2.9	2.5	2.1		3.0	2.6	2.1		2.8	2.7	2.2	1.9		2.7	2.8	2.2	1.8	54
56	2.8	2.4	2.0		2.8	2.4	2.1		2.9	2.5	2.1		2.7	2.6	2.1			2.6	2.6	2.2	1.8	56
58	2.7	2.3	2.0		2.8	2.4	2.1		2.9	2.4	2.1		2.7	2.5	2.1			2.5	2.5	2.2		58
60	2.6	2.2	2.0		2.7	2.3	2.0		2.8	2.3	2.1		2.5	2.3	2.1			2.2	2.3	2.2		60
62	2.5	2.1			2.5	2.2	2.0		2.7	2.3	2.1		2.4	2.2	2.1			2.1	2.2	2.2		62
64	2.4	2.1			2.3	2.1	2.0		2.5	2.2	2.0		2.2	2.1	2.1			1.9	2.0	2.1		64
66	2.3	2.0			2.2	2.1	1.9		2.4	2.1	2.0		2.1	2.0	2.0			1.8	1.9	1.9		66
68	2.1	2.0			2.0	2.0			2.2	2.0	1.9		2.0	1.9	1.9			1.6	1.7	1.7		68
70	2.0				1.8	1.9			2.0	1.9			1.8	1.7	1.8			1.4	1.6	1.5		70
72	0.7				1.7	1.9			1.8	1.9			1.7	1.6	1.7			1.3	1.4	1.2		72
74					1.5				1.6	1.7			1.4	1.5	1.6			1.1	1.2	1.0		74
76									1.4	1.6			1.3	1.3				1.0	1.1	0.9		76
78									1.2	1.4			1.1	1.2								78
80													1.0	1.1								80
82													0.8	1.0								82

Operating Range-TEJ / TEH

起升高度曲线 - 主臂延伸节 + 副臂

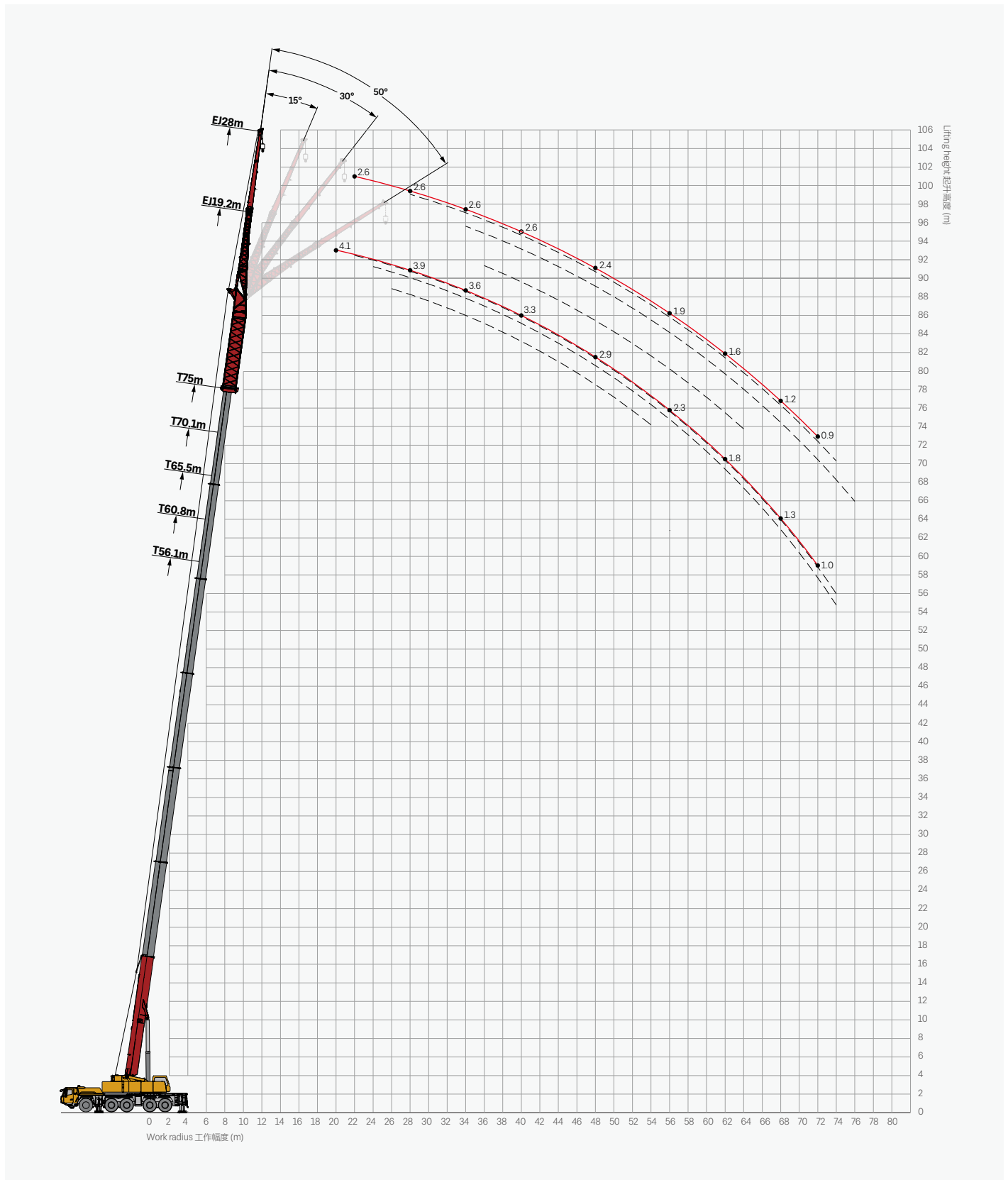

Load Chart-TEJ / TEH

性能表 - 主臂延伸节 + 副臂

Unit: t

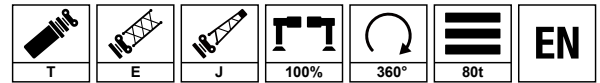

m	56.1				60.8				65.5				70.1				75.0				m	
	19.2				19.2				19.2				19.2				19.2					
	0°	15°	30°	50°	0°	15°	30°	50°	0°	15°	30°	50°	0°	15°	30°	50°	0°	15°	30°	50°		
16	11.0																				16	
18	10.7	9.2			7.7				6.2												18	
20	10.4	9.2	8.9		7.7	7.6			6.2	6.2			5.0				4.1				20	
22	10.1	9.2	8.7	6.9	7.7	7.6	7.4		6.2	6.2	6.1		5.0	5.0			4.0	4.2			22	
24	9.8	9.0	8.3	6.7	7.7	7.6	7.2	6.4	6.2	6.1	6.1	6.0	5.0	5.0	5.0		4.0	4.1	4.2		24	
26	9.4	8.7	7.9	6.5	7.7	7.3	6.9	6.2	6.0	6.0	5.9	5.8	5.0	5.0	5.0	5.0	4.0	4.0	4.1	4.1	26	
28	9.2	8.4	7.7	6.4	7.5	7.1	6.8	6.1	5.9	5.7	5.9	5.8	4.9	4.8	4.9	4.9	3.9	3.9	4.0	4.0	28	
30	8.9	8.1	7.4	6.3	7.3	6.8	6.5	5.9	5.7	5.5	5.6	5.5	4.7	4.7	4.7	4.7	3.8	3.9	3.9	3.9	30	
32	8.6	7.8	7.1	6.2	7.0	6.6	6.3	5.8	5.4	5.4	5.4	5.3	4.6	4.6	4.6	4.6	3.7	3.8	3.8	3.8	32	
34	8.3	7.5	6.8	6.0	6.8	6.4	6.0	5.6	5.3	5.2	5.2	5.2	4.5	4.5	4.5	4.4	3.6	3.7	3.7	3.7	34	
36	7.9	7.3	6.6	5.9	6.5	6.1	5.8	5.4	5.1	5.0	5.0	4.9	4.3	4.3	4.3	4.3	3.5	3.6	3.6	3.6	36	
38	7.5	7.0	6.4	5.8	6.2	5.9	5.6	5.3	4.9	4.8	4.8	4.7	4.1	4.1	4.1	4.1	3.4	3.4	3.5	3.5	38	
40	6.8	6.8	6.2	5.8	5.8	5.7	5.4	5.2	4.8	4.7	4.6	4.6	4.0	4.0	4.0	4.0	3.3	3.3	3.4	3.4	40	
42	6.3	6.5	6.0	5.6	5.4	5.5	5.3	5.1	4.6	4.5	4.5	4.5	3.9	3.9	3.9	3.9	3.2	3.2	3.3	3.3	42	
44	5.7	6.1	5.8	5.5	5.1	5.2	5.1	4.9	4.5	4.4	4.3	4.3	3.8	3.7	3.8	3.8	3.1	3.1	3.2	3.2	44	
46	5.2	5.7	5.6		4.7	5.0	4.9	4.8	4.3	4.3	4.2	4.2	3.7	3.7	3.7	3.7	3.1	3.0	3.1	3.1	46	
48	4.8	5.4	5.2		4.5	4.7	4.7		4.1	4.1	4.1	4.0	3.5	3.6	3.5	3.5	2.9	3.0	3.0	3.0	48	
50	4.5	4.9	4.9		4.2	4.4	4.4		4.0	4.1	4.0		3.4	3.5	3.4	3.4	2.8	2.9	2.9	2.9	50	
52	3.9	4.6	4.6		3.9	4.2	4.2		3.9	4.0	3.9		3.3	3.4	3.3	3.3	2.6	2.8	2.8	2.8	52	
54	3.5	4.1	4.2		3.5	3.8	4.0		3.7	3.8	3.8		3.1	3.2	3.3		2.5	2.6	2.7	2.7	54	
56	3.1	3.7	3.7		3.2	3.5	3.6		3.4	3.6	3.6		2.9	3.0	3.1		2.3	2.5	2.6		56	
58	2.8	3.3	3.3		3.0	3.2	3.4		3.3	3.4	3.4		2.8	2.9	2.9		2.2	2.3	2.5		58	
60	2.5	3.1	3.0		2.7	3.0	3.1		3.1	3.3	3.2		2.5	2.7	2.7		2.0	2.1	2.2		60	
62	2.3	2.8			2.5	2.8	2.9		2.8	3.0	2.9		2.3	2.5	2.5		1.8	2.0	2.1		62	
64	2.0	2.6			2.2	2.5			2.5	2.7	2.7		2.1	2.3	2.3		1.7	1.8	1.9		64	
66	1.8	2.3			2.0	2.2			2.4	2.5	2.4		1.9	2.0	2.1		1.5	1.6	1.7		66	
68	1.7	2.1			1.9	2.0			2.3	2.3			1.8	1.9	1.9		1.3	1.5	1.5		68	
70	1.5				1.7	1.9			2.1	2.2			1.6	1.7	1.7		1.2	1.3	1.4		70	
72					1.6	1.8			1.9	2.0			1.4	1.5			1.0	1.1	1.2		72	
74					1.2				1.6	1.7			1.2	1.3				1.0	1.0			74
76									1.4	1.5			1.0	1.1								76
78									1.0				0.8	0.9								78

Load Chart-TEJ / TEH

性能表 - 主臂延伸节 + 副臂

Unit: t

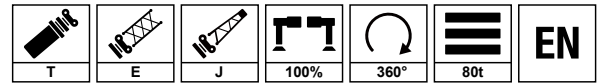

m	56.1				60.8				65.5				70.1				75.0				m
	28.0				28.0				28.0				28.0				28.0				
	0°	15°	30°	50°	0°	15°	30°	50°	0°	15°	30°	50°	0°	15°	30°	50°	0°	15°	30°	50°	
18	4.9																				18
20	4.8				4.3				3.8												20
22	4.7	4.4			4.3				3.8				3.2				2.6				22
24	4.6	4.3			4.2	4.0			3.8	3.8			3.2				2.6				24
26	4.5	4.1	3.7		4.2	3.9			3.8	3.7	3.4		3.2	3.2			2.6				26
28	4.4	4.0	3.5		4.1	3.8	3.5		3.8	3.7	3.4		3.2	3.2			2.6	2.7			28
30	4.2	3.8	3.5	2.1	4.0	3.7	3.4		3.8	3.6	3.4		3.2	3.2			2.6	2.7			30
32	4.2	3.7	3.3	2.0	3.9	3.6	3.3	2.1	3.7	3.6	3.4	2.1	3.2	3.1	3.0		2.6	2.7			32
34	4.0	3.5	3.2	2.0	3.9	3.5	3.2	2.0	3.7	3.6	3.3	2.0	3.2	3.1	3.0	2.4	2.6	2.7	2.7		34
36	3.9	3.5	3.0	1.9	3.8	3.5	3.2	1.9	3.6	3.5	3.3	2.0	3.1	3.1	3.0	2.4	2.6	2.7	2.7	2.7	36
38	3.8	3.3	3.0	1.9	3.7	3.4	3.1	1.9	3.6	3.5	3.3	2.0	3.1	3.1	3.0	2.4	2.6	2.6	2.7	2.7	38
40	3.8	3.2	2.9	1.9	3.7	3.3	3.0	1.9	3.6	3.4	3.2	2.0	3.1	3.0	2.9	2.4	2.6	2.6	2.7	2.7	40
42	3.7	3.1	2.8	1.9	3.6	3.3	3.0	1.9	3.5	3.4	3.2	2.0	3.1	3.0	2.9	2.3	2.6	2.6	2.6	2.6	42
44	3.5	3.0	2.7	1.9	3.5	3.2	2.9	1.9	3.4	3.3	3.1	2.0	3.0	2.9	2.9	2.3	2.5	2.5	2.6	2.6	44
46	3.4	2.9	2.6	1.9	3.4	3.1	2.9	1.9	3.4	3.3	3.1	2.0	2.9	2.9	2.8	2.3	2.4	2.5	2.4	2.5	46
48	3.4	2.8	2.5	1.8	3.3	3.0	2.8	1.8	3.3	3.2	3.1	2.0	2.8	2.8	2.7	2.2	2.4	2.4	2.3	2.4	48
50	3.3	2.8	2.5	1.8	3.2	3.0	2.8	1.8	3.2	3.2	3.1	2.0	2.7	2.8	2.7	2.2	2.3	2.3	2.3	2.4	50
52	3.1	2.6	2.4	1.8	3.1	2.9	2.8	1.8	3.1	3.2	3.1	2.0	2.6	2.7	2.7	2.2	2.2	2.2	2.2	2.3	52
54	3.0	2.6	2.3	1.8	3.0	2.8	2.7	1.8	3.0	3.1	3.0	2.0	2.5	2.6	2.6	2.1	2.0	2.2	2.1	2.2	54
56	2.9	2.5	2.3	1.8	3.0	2.8	2.6	1.8	3.0	3.0	3.0	2.0	2.4	2.5	2.6	2.1	1.9	2.1	2.1	2.2	56
58	2.9	2.4	2.2	1.8	2.9	2.7	2.6		2.9	3.0	2.9	1.9	2.4	2.5	2.5	2.0	1.8	2.0	2.0	2.1	58
60	2.8	2.4	2.1		2.8	2.6	2.5		2.8	2.9	2.8		2.3	2.4	2.4	1.9	1.8	1.8	1.9	2.0	60
62	2.7	2.3	2.1		2.6	2.5	2.4		2.7	2.8	2.7		2.1	2.3	2.3		1.6	1.8	1.9	2.0	62
64	2.5	2.2	2.0		2.4	2.3	2.4		2.5	2.6	2.7		2.0	2.2	2.2		1.5	1.7	1.8	1.9	64
66	2.3	2.0	2.0		2.2	2.1	2.3		2.4	2.5	2.6		1.9	2.0	2.1		1.3	1.6	1.7		66
68	2.0	1.9	1.9		1.9	1.9	2.2		2.1	2.3	2.4		1.7	1.9	2.0		1.2	1.4	1.6		68
70	1.7	1.9			1.7	1.8	2.1		1.9	2.2	2.3		1.5	1.8	1.8		1.1	1.3	1.4		70
72	1.4	1.8			1.4	1.6	2.0		1.8	1.9	2.0		1.3	1.5	1.6		0.9	1.1	1.3		72
74	1.2	1.6			1.3	1.4			1.7	1.8	1.8		1.2	1.4	1.4			1.0	1.1		74
76	1.1	1.5			1.1	1.3			1.6	1.7	1.7			1.3	1.3				0.9		76
78	1.0				1.0	1.2			1.4	1.6					1.2						78
80					0.9	1.0			1.2	1.4											80
82					0.7				1.0	1.1											82
84										0.9											84

Operating Range-TE2J / TE2H

起升高度曲线 - 主臂延伸节 + 副臂

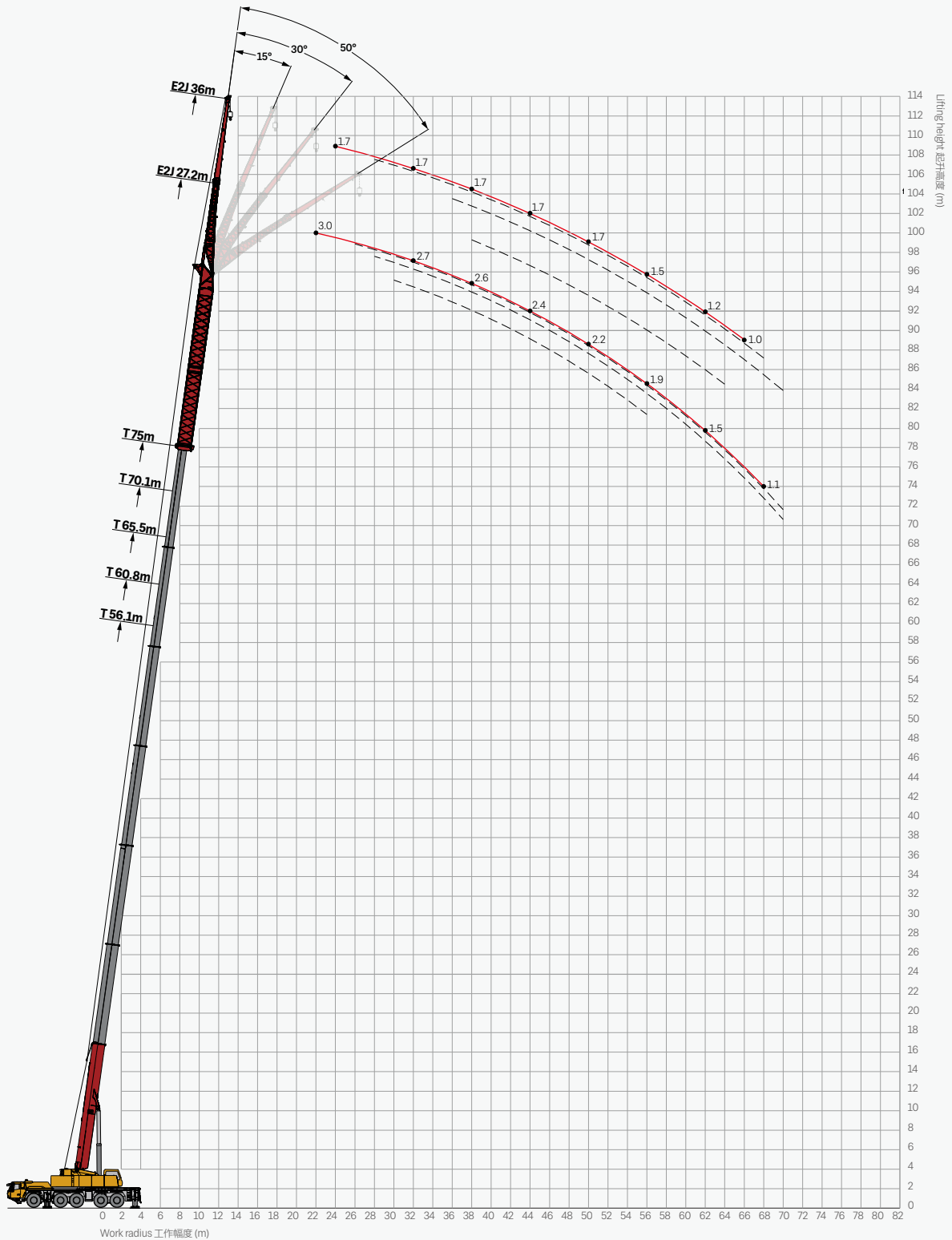

Load Chart-TE2J / TE2H

性能表 - 主臂延伸节 + 副臂

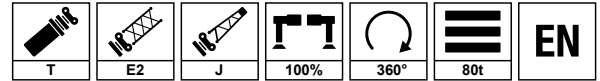

Unit: t

m	56.1				60.8				65.5				70.1				75.0				m
	27.2				27.2				27.2				27.2				27.2				
	0°	15°	30°	50°	0°	15°	30°	50°	0°	15°	30°	50°	0°	15°	30°	50°	0°	15°	30°	50°	
18	6.5																				18
20	6.5	6.5			5.5				4.5												20
22	6.5	6.4	5.5		5.5	5.5			4.5	4.5			3.6				3.0				22
24	6.5	6.2	5.4	5.1	5.5	5.4	5.0		4.5	4.5			3.6				3.0				24
26	6.2	5.9	5.2	5.0	5.4	5.2	4.9	4.7	4.5	4.5	4.4		3.6	3.6	3.5		2.9	2.9			26
28	6.0	5.7	5.1	4.8	5.3	5.1	4.7	4.6	4.5	4.5	4.4	4.2	3.6	3.6	3.5	3.5	2.9	2.9	2.9		28
30	5.8	5.5	4.9	4.7	5.1	4.9	4.7	4.6	4.4	4.4	4.4	4.2	3.6	3.6	3.5	3.5	2.8	2.8	2.8	2.9	30
32	5.6	5.3	4.8	4.6	5.0	4.8	4.5	4.4	4.3	4.3	4.3	4.2	3.5	3.5	3.5	3.5	2.7	2.7	2.8	2.9	32
34	5.4	5.1	4.6	4.4	4.8	4.6	4.4	4.3	4.2	4.1	4.2	4.2	3.5	3.4	3.5	3.5	2.7	2.7	2.7	2.8	34
36	5.2	4.9	4.4	4.3	4.7	4.5	4.3	4.2	4.1	4.0	4.1	4.1	3.4	3.3	3.4	3.4	2.7	2.7	2.6	2.7	36
38	5.0	4.8	4.4	4.3	4.5	4.4	4.2	4.1	3.9	3.9	4.0	4.0	3.2	3.3	3.3	3.4	2.6	2.6	2.6	2.7	38
40	4.9	4.6	4.2	4.1	4.4	4.2	4.0	4.0	3.8	3.7	3.8	3.8	3.2	3.2	3.2	3.2	2.6	2.6	2.6	2.6	40
42	4.7	4.4	4.1	4.1	4.2	4.0	3.9	3.9	3.7	3.6	3.7	3.7	3.1	3.1	3.1	3.1	2.5	2.5	2.5	2.5	42
44	4.5	4.3	4.0	4.0	4.0	3.9	3.8	3.8	3.5	3.5	3.6	3.6	3.0	3.0	3.0	3.0	2.4	2.4	2.4	2.4	44
46	4.4	4.1	4.0	3.9	3.9	3.8	3.7	3.7	3.4	3.4	3.5	3.5	2.9	2.9	2.9	3.0	2.3	2.3	2.4	2.4	46
48	4.2	4.0	3.8	3.8	3.8	3.6	3.6	3.6	3.3	3.2	3.4	3.4	2.8	2.8	2.8	2.8	2.2	2.3	2.3	2.3	48
50	4.1	3.9	3.7		3.7	3.5	3.5		3.2	3.1	3.2	3.2	2.7	2.7	2.7	2.7	2.2	2.2	2.2	2.2	50
52	4.0	3.8	3.6		3.6	3.4	3.4		3.1	3.0	3.1		2.6	2.6	2.6	2.6	2.1	2.1	2.1	2.1	52
54	3.9	3.7	3.6		3.5	3.3	3.3		3.0	2.9	3.0		2.5	2.5	2.6	2.6	2.0	2.0	2.1	2.1	54
56	3.6	3.6	3.6		3.2	3.2	3.2		2.9	2.8	2.9		2.4	2.4	2.5		1.9	1.9	2.0	2.0	56
58	3.4	3.5	3.5		3.0	3.1	3.2		2.8	2.7	2.9		2.3	2.3	2.4		1.8	1.8	1.9		58
60	3.2	3.4	3.4		2.8	3.0	3.1		2.7	2.6	2.8		2.1	2.2	2.3		1.6	1.7	1.8		60
62	2.9	3.0	3.2		2.5	2.8	2.9		2.4	2.6	2.6		2.0	2.1	2.2		1.5	1.6	1.7		62
64	2.6	2.7	2.9		2.3	2.5	2.7		2.3	2.5	2.5		1.9	2.0	2.0		1.4	1.5	1.6		64
66	2.3	2.4	2.7		2.1	2.2	2.5		2.1	2.2	2.3		1.6	1.8	1.9		1.2	1.3	1.4		66
68	2.2	2.3			1.8	2.0	2.3		1.8	2.0	2.1		1.4	1.6	1.7		1.1	1.2	1.3		68
70	1.9	1.9			1.6	1.7			1.7	1.8	1.8		1.2	1.4	1.5			1.0	1.1		70
72	1.7	1.7			1.5	1.5			1.7	1.7	1.7			1.2	1.2						72
74	1.5	1.5			1.3	1.4			1.5	1.6											74
76	1.4				1.1	1.2			1.3	1.4											76
78					1.0	1.0			1.1	1.2											78
80					0.8	0.9			0.9	1.0											80

Load Chart-TE2J / TE2H

性能表 - 主臂延伸节 + 副臂

Unit: t

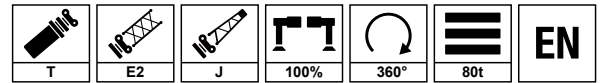

m	56.1				60.8				65.5				70.1				75.0				m
	36.0				36.0				36.0				36.0				36.0				
	0°	15°	30°	50°	0°	15°	30°	50°	0°	15°	30°	50°	0°	15°	30°	50°	0°	15°	30°	50°	
20	3.8																				20
22	3.7				3.4				2.9												22
24	3.7	3.8			3.3				2.9				2.3				1.7				24
26	3.6	3.7			3.3	3.3			2.9	2.9			2.3				1.7				26
28	3.5	3.6	3.5		3.2	3.3			2.9	2.9			2.3	2.4			1.7	2.0			28
30	3.4	3.5	3.5		3.2	3.2	3.1		2.9	2.9			2.3	2.4			1.7	2.0			30
32	3.4	3.4	3.4	2.2	3.1	3.1	3.1		2.9	2.8	2.7		2.3	2.4			1.7	2.0			32
34	3.3	3.3	3.4	2.2	3.1	3.0	3.0	2.1	2.8	2.8	2.7	2.1	2.3	2.4	2.3		1.7	2.0			34
36	3.2	3.2	3.3	2.2	3.0	3.0	3.0	2.1	2.8	2.7	2.7	2.1	2.3	2.4	2.3	2.1	1.7	2.0			36
38	3.1	3.1	3.2	2.2	3.0	2.9	2.9	2.1	2.8	2.7	2.7	2.1	2.2	2.3	2.3	2.1	1.7	2.0	1.9	1.8	38
40	3.1	3.0	3.1	2.2	2.9	2.8	2.9	2.1	2.8	2.7	2.6	2.1	2.2	2.3	2.3	2.1	1.7	1.9	1.9	1.8	40
42	3.0	2.9	3.0	2.2	2.9	2.8	2.8	2.1	2.7	2.6	2.6	2.1	2.2	2.3	2.3	2.1	1.7	1.9	1.9	1.8	42
44	2.9	2.8	2.9	2.2	2.8	2.7	2.7	2.1	2.7	2.5	2.5	2.1	2.2	2.2	2.2	2.1	1.7	1.9	1.8	1.8	44
46	2.8	2.7	2.8	2.2	2.8	2.6	2.7	2.1	2.7	2.5	2.5	2.1	2.2	2.2	2.2	2.0	1.7	1.8	1.8	1.8	46
48	2.8	2.6	2.7	2.2	2.7	2.6	2.6	2.1	2.6	2.5	2.5	2.1	2.1	2.1	2.1	2.0	1.7	1.8	1.8	1.8	48
50	2.7	2.5	2.7	2.2	2.6	2.5	2.5	2.1	2.5	2.5	2.4	2.1	2.1	2.1	2.1	1.9	1.7	1.7	1.8	1.8	50
52	2.6	2.5	2.6	2.2	2.6	2.5	2.5	2.1	2.5	2.4	2.4	2.1	2.1	2.0	2.0	1.9	1.7	1.7	1.7	1.7	52
54	2.5	2.5	2.5	2.2	2.5	2.4	2.4	2.1	2.5	2.3	2.3	2.1	2.0	2.0	2.0	1.9	1.6	1.6	1.7	1.7	54
56	2.4	2.4	2.4	2.2	2.4	2.4	2.4	2.1	2.4	2.4	2.3	2.1	1.9	2.0	2.0	1.8	1.5	1.6	1.6	1.6	56
58	2.4	2.3	2.3		2.4	2.3	2.3	2.1	2.3	2.3	2.2	2.1	1.8	1.9	1.9	1.8	1.4	1.5	1.6	1.6	58
60	2.4	2.3	2.2		2.3	2.2	2.2	2.1	2.3	2.2	2.2	2.1	1.8	1.8	1.9	1.8	1.3	1.5	1.5	1.5	60
62	2.3	2.2	2.2		2.2	2.2	2.2		2.2	2.2	2.2	2.1	1.7	1.8	1.8	1.8	1.2	1.4	1.5	1.5	62
64	2.2	2.1	2.1		2.1	2.1	2.1		2.1	2.1	2.1		1.6	1.7	1.7		1.1	1.3	1.4	1.4	64
66	2.2	2.1	2.1		2.1	2.0	2.1		1.9	1.9	2.1		1.5	1.6	1.7		1.0	1.2	1.2	1.3	66
68	1.9	2.0	2.1		2.0	1.9	2.0		1.9	1.9	2.0			1.5	1.5			1.1	1.1		68
70	1.7	2.0	2.0		1.8	1.9	1.9		1.8	1.8	1.8			1.4	1.4				1.0		70
72	1.5	1.8	1.9		1.6	1.8	1.8		1.5	1.6	1.8										72
74	1.3	1.6	1.8		1.4	1.6	1.7		1.3	1.5	1.7										74
76	1.1	1.3	1.6		1.3	1.4	1.6		1.2	1.3	1.5										76
78	0.9	1.1			1.2	1.2	1.3		1.2	1.1	1.2										78
80	0.7	0.8			1.1	1.1			1.1	1.0	1.1										80
82		0.7				1.0			0.9	1.0	1.0										82
84										0.8											84

Operating Range - TE2J / TE2H

起升高度曲线 - 主臂延伸节 + 副臂

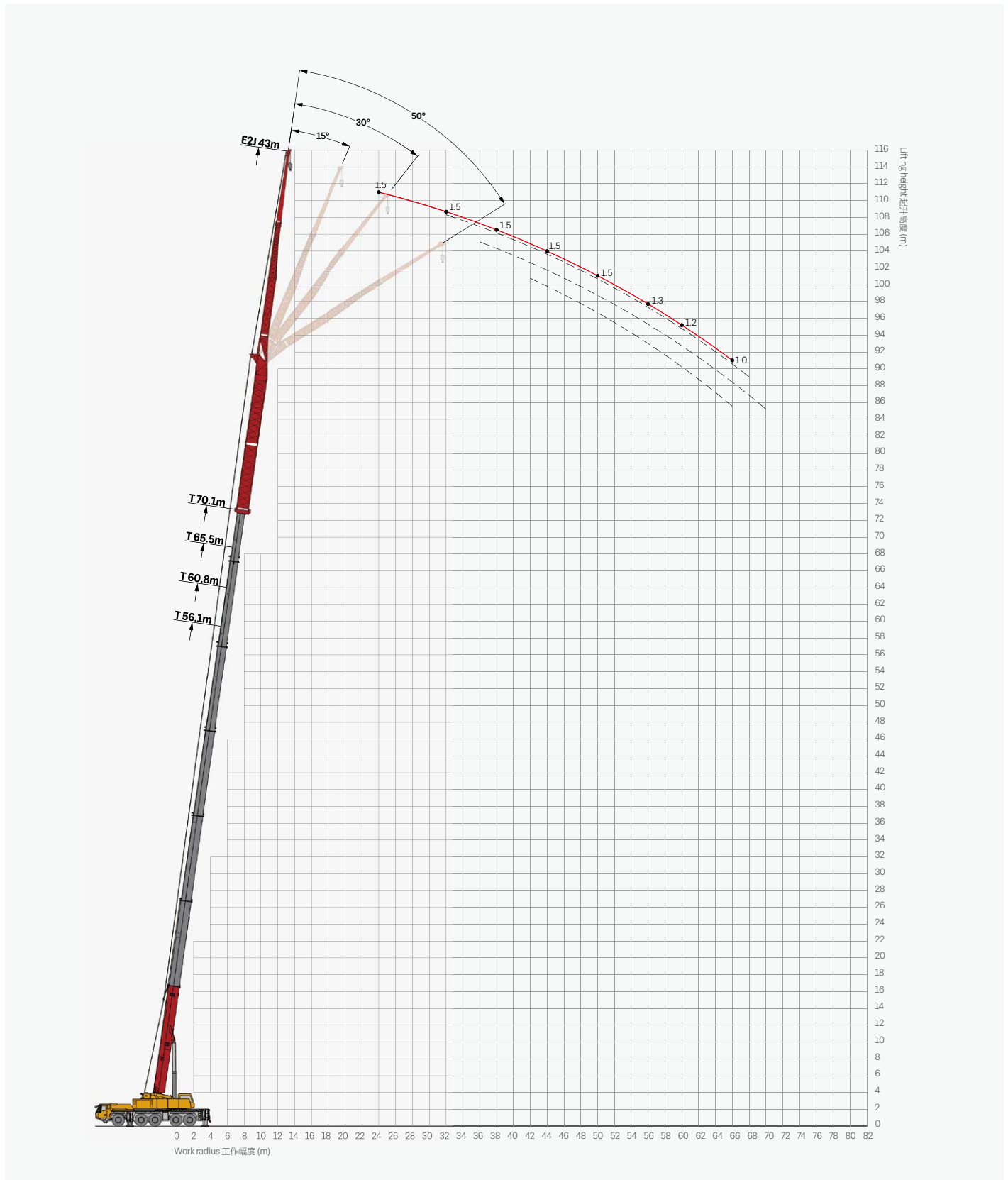

Load Chart-TE2J / TE2H

性能表 - 主臂延伸节 + 副臂

Unit: t

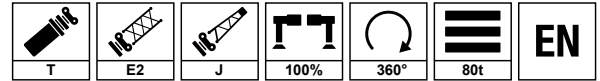

m	56.1				60.8				65.5				70.1				m
	43.0				43.0				43.0				43.0				
	0°	15°	30°	50°	0°	15°	30°	50°	0°	15°	30°	50°	0°	15°	30°	50°	
22	2.7				2.3												22
24	2.7				2.3				1.9				1.5				24
26	2.7				2.3				1.9				1.5				26
28	2.7	2.6			2.3	2.3			1.9				1.5				28
30	2.7	2.6			2.3	2.3			1.9	1.9			1.5				30
32	2.7	2.6	2.3		2.3	2.3			1.9	1.9			1.5	1.5			32
34	2.7	2.6	2.3		2.3	2.3	2.0		1.9	1.9			1.5	1.5			34
36	2.7	2.6	2.3		2.3	2.3	2.0		1.9	1.9	1.7		1.5	1.5	1.4		36
38	2.6	2.6	2.3	1.9	2.3	2.2	2.0	1.7	1.9	1.9	1.7		1.5	1.5	1.4		38
40	2.6	2.5	2.3	1.9	2.2	2.2	2.0	1.7	1.9	1.9	1.7	1.5	1.5	1.5	1.4		40
42	2.5	2.5	2.3	1.9	2.2	2.2	2.0	1.7	1.9	1.8	1.7	1.5	1.5	1.5	1.4	1.3	42
44	2.4	2.4	2.3	1.9	2.1	2.1	2.0	1.7	1.8	1.8	1.7	1.5	1.5	1.5	1.4	1.3	44
46	2.3	2.3	2.3	1.9	2.1	2.1	2.0	1.7	1.8	1.8	1.7	1.5	1.5	1.5	1.4	1.3	46
48	2.3	2.3	2.3	1.9	2.1	2.0	2.0	1.7	1.8	1.7	1.7	1.5	1.5	1.5	1.4	1.3	48
50	2.3	2.3	2.3	1.9	2.0	2.0	2.0	1.7	1.8	1.7	1.7	1.5	1.5	1.5	1.4	1.3	50
52	2.2	2.2	2.2	1.9	1.9	1.9	1.9	1.7	1.7	1.7	1.6	1.4	1.4	1.4	1.4	1.3	52
54	2.1	2.1	2.1	1.9	1.9	1.9	1.9	1.7	1.6	1.6	1.6	1.5	1.4	1.4	1.4	1.3	54
56	2.1	2.1	2.1	1.9	1.8	1.8	1.8	1.7	1.6	1.6	1.6	1.5	1.3	1.3	1.3	1.3	56
58	2.0	2.0	2.0	1.8	1.8	1.8	1.8	1.6	1.5	1.5	1.5	1.5	1.3	1.3	1.3	1.3	58
60	1.9	1.9	1.9	1.7	1.6	1.6	1.6	1.5	1.4	1.4	1.4	1.4	1.2	1.2	1.2	1.2	60
62	1.8	1.9	1.9	1.7	1.6	1.6	1.6	1.5	1.4	1.4	1.4	1.4	1.2	1.2	1.2	1.2	62
64	1.7	1.7	1.7		1.5	1.5	1.5	1.4	1.3	1.3	1.3	1.3	1.1	1.1	1.1	1.1	64
66	1.6	1.6	1.6		1.4	1.4	1.4		1.2	1.3	1.3	1.2	1.0	1.1	1.1	1.0	66
68	1.6	1.6	1.6		1.4	1.4	1.4		1.2	1.2	1.3	1.2		1.0	1.1		68
70	1.5	1.5	1.5		1.3	1.3	1.3		1.1	1.1	1.2				1.0		70
72	1.5	1.5	1.5		1.3	1.3	1.3		1.1	1.1	1.2						72
74	1.4	1.4	1.4		1.2	1.2	1.2		1.0	1.0	1.1						74
76	1.3	1.3	1.3		1.1	1.1	1.1			0.9	1.0						76
78	1.2	1.2	1.2		1.0	1.0	1.0			0.9	0.9						78
80	1.1	1.1	1.1			0.9	0.9				0.8						80
82		1.1															82

Remark

1. Value listed are the max. capacity when the crane is in a level condition on solid ground or surface.
2. Radius refers to actual radius with boom deflection considered.
3. Value above are calculated with hooks and lifting slings considered.

- 1、起重性能表中给定数值是在平整坚固的地面上，整机调平状态下起重机的额定起重量。
- 2、起重性能表中工作幅度是指吊载后的实际幅度。
- 3、起重性能表中额定起重量包括起重钩和吊具的重量。



SANY GROUP CRANE BU

SANY Mobile Crane Industrial Park, No.168 Jinzhou Avenue, Jinzhou Development Zone, Changsha City,
Hunan Province, P.R. China Zip 410600
Consulting sanycrane@sanygroup.com (Crane BU) / crd@sany.com.cn (IHQ)
After-sales Service 0086-400 6098 318

Reminder:

Any change in the technical parameters and configuration due to product modification or upgrade may occur without prior notice.
The machine in the picture may include additional equipment. This brochure is for reference only, and goods in kind shall prevail.
Copyright at SANY. No part of this brochure may be copied or used for any purpose without written approval from SANY.

© Edited in June 2024

三一集团起重事业部

中国湖南长沙金洲开发区金洲大道 168 号 三一汽车起重机产业园 邮编: 410600
咨询: sanycrane@sanygroup.com (起重事业部) / crd@sany.com.cn (国际总部)
海外售后服务: 0086-400 6098 318

温馨提示:

由于技术不断更新, 技术参数及配置如有更改, 恕不另行通知。图中机器可能包括附加设备, 本画册仅供参考, 以实物为准。
版权为三一所有, 未经三一书面许可, 本画册任何内容不得被复制用于任何目的。

© 2024 年 6 月版

